

Air

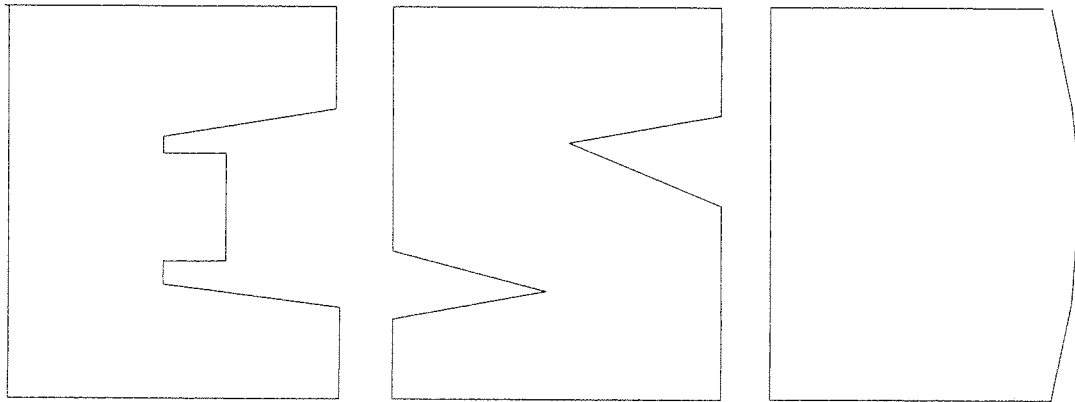

Protocol for Equipment Leak Emission Estimates

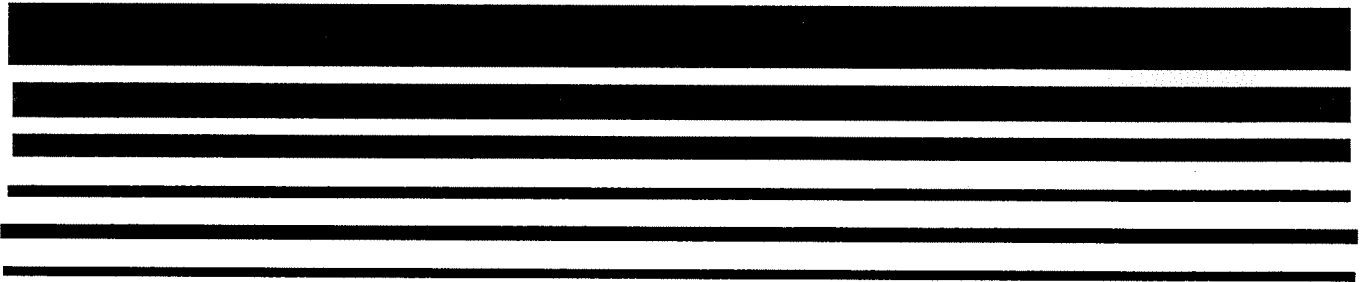

**MEDICINE BOW
EXHIBIT K
PRE-HRG MEMO**

1995 Protocol for Equipment Leak Emission Estimates

Emission Standards Division

U.S. ENVIRONMENTAL PROTECTION AGENCY
Office of Air and Radiation
Office of Air Quality Planning and Standards
Research Triangle Park, North Carolina 27711

November 1995

This report has been reviewed by the Emission Standards Division of the Office of Air Quality Planning and Standards, the EPA and approved for publication. Mention of trade names or commercial products is not intended to constitute endorsement or recommendation for use. Copies of this report are available through the Library Services Office (MD-35), U.S. Environmental Protection Agency, Research Triangle Park, North Carolina 27711; from the Office of Air Quality Planning and Standards Technology Transfer Network, U.S. Environmental Protection Agency, Research Triangle Park, North Carolina 27711; or, for a fee, from the National Technical Information Services, 5285 Port Royal Road, Springfield, Virginia 22161.

Publication No. EPA-453/R-95-017

FOREWORD

The EPA's protocol for estimating equipment leak emissions is the result of detailed information gathering and data analysis. The protocol was written to provide a thorough understanding of acceptable approaches to generating process unit-specific emission estimates. In preparing this document, the EPA has encouraged knowledgeable individuals in industry and the regulatory community to provide comments.

The EPA has put forth considerable effort to make this document as comprehensive as possible. However, it should be understood that not all details and topics pertaining to equipment leaks could feasibly be included in this document. Additionally, it should be understood that the procedures presented in this document are not necessarily suitable for all applications. There will be cases where it will be necessary for the user of the document to make a professional judgement as to the appropriate technical approach for collecting and analyzing data used to estimate equipment leak emissions.

Additional data on equipment leak emissions continues to be collected. It is the intent of the EPA to periodically update this document after analysis of the data warrants such an update. For example, data recently collected in the petroleum industry has been used to revise the existing refinery correlations, which are based on data collected in the late 1970s. Furthermore, as new techniques for collecting and analyzing data are developed, they will be included in updated versions of this document.

Mention of any manufacturer or company name within this document does not represent endorsement by the EPA.

TABLE OF CONTENTS

<u>Section</u>	<u>Page</u>
FOREWORD	i
1.0 INTRODUCTION	1-1
2.0 DEVELOPMENT OF EQUIPMENT LEAK EMISSION ESTIMATES	2-1
2.1 Introduction	2-1
2.2 General Information on the Approaches for Estimating Equipment Leak Emissions	2-3
2.2.1 Equipment Leak Emission Estimation Approaches	2-3
2.2.2 Overview of Equipment Leak Data Collection	2-6
2.3 Approaches for Estimating Equipment Leak Emissions	2-10
2.3.1 Average Emission Factor Approach	2-10
2.3.2 Screening Ranges Approach	2-18
2.3.3 EPA Correlation Approach	2-24
2.3.4 Unit-Specific Correlation Approach	2-38
2.4 Special Topics	2-44
2.4.1 Speciating Emissions	2-45
2.4.2 Using Response Factors	2-46
2.4.3 Monitoring Instrument Type and Calibration Gas	2-51
2.4.4 Estimating Emissions for Equipment Not Screened	2-51
2.4.5 Using Screening Data Collected at Several Different Times	2-52
2.4.6 Estimating VOC Emission Rates from Equipment Containing Non-VOC's	2-52
2.4.7 Estimating Equipment Leak Emissions of Inorganic Compounds	2-53
2.5 References	2-54
3.0 SOURCE SCREENING	3-1
3.1 Introduction	3-1
3.2 Monitoring Instruments	3-2
3.2.1 Operating Principles and Limitations of Portable VOC Detection Devices	3-2

TABLE OF CONTENTS (Continued)

<u>Section</u>	<u>Page</u>
3.2.2 Specifications and Performance Criteria of Portable VOC Detection Devices	3-4
3.2.3 Use of Monitoring Devices That Do Not Meet EPA Reference Method 21 Requirements . . .	3-10
3.3 The Screening Program	3-12
3.3.1 Identification of Equipment to be Screened	3-12
3.3.2 Procedure for Screening	3-15
3.3.3 Data Handling	3-25
3.4 References	3-27
4.0 MASS EMISSION SAMPLING	4-1
4.1 Introduction	4-1
4.2 Sampling Methods	4-2
4.2.1 Vacuum Method	4-4
4.2.2 Blow-Through Method	4-8
4.3 Source Enclosure	4-15
4.3.1 Valves	4-15
4.3.2 Pumps and Agitators	4-16
4.3.3 Compressors	4-17
4.3.4 Connectors	4-17
4.3.5 Relief Valves	4-18
4.4 Analytical Techniques	4-18
4.4.1 Analytical Instrumentation	4-19
4.4.2 Calibration of Analytical Instruments . .	4-19
4.4.3 Analytical Techniques for Condensate . . .	4-21
4.4.4 Calibration Procedures for the Portable Monitoring Instrument	4-21
4.5 Quality Control and Quality Assurance Guidelines	4-21
4.5.1 Quality Control Procedures	4-22
4.5.2 Quality Assurance Procedures	4-25
4.6 References	4-29
5.0 ESTIMATION OF CONTROL EFFICIENCIES FOR EQUIPMENT LEAK CONTROL TECHNIQUES	5-1
5.1 Introduction	5-1

TABLE OF CONTENTS (Continued)

<u>Section</u>	<u>Page</u>
5.2 Equipment Modification Control Efficiency	5-1
5.2.1 Closed-Vent Systems	5-2
5.2.2 Pumps	5-2
5.2.3 Compressors	5-4
5.2.4 Pressure Relief Valves	5-4
5.2.5 Valves	5-5
5.2.6 Connectors	5-5
5.2.7 Open-Ended Lines	5-6
5.2.8 Sampling Connections	5-6
5.3 Leak Detection and Repair Control Effectiveness . .	5-6
5.3.1 Approach for Estimating LDAR Control Effectiveness	5-8
5.3.2 Example Application of Approach	5-57
5.4 References	5-61

APPENDICES

A Example Calculations	A-1
B Leak Rate Screening Value Correlation Development and Revision of SOCFI Correlations and Emission Factors . .	B-1
C Revision of Petroleum Industry Correlations and Emission Factor	C-1
D Response Factors	D-1
E Selection of Sample Size for Screening Connectors . . .	E-1
F Reference Method 21	F-1
G Development of Leak Rate Versus Fraction Leaking Equations and Determination of LDAR Control Effectiveness	G-1

LIST OF TABLES

<u>Table</u>		<u>Page</u>
2-1	SOCMI Average Emission Factors	2-12
2-2	Refinery Average Emission Factors	2-13
2-3	Marketing Terminal Average Emission Factors	2-14
2-4	Oil and Gas Production Operations Average Emission Factors	2-15
2-5	SOCMI Screening Ranges Emission Factors	2-19
2-6	Refinery Screening Ranges Emission Factors	2-20
2-7	Marketing Terminal Screening Ranges Emission Factors	2-21
2-8	Oil and Gas Production Operations Screening Ranges Emission Factors	2-22
2-9	SOCMI Leak Rate/Screening Value Correlations	2-26
2-10	Petroleum Industry Leak Rate/Screening Value Correlations	2-27
2-11	Default-Zero Values: SOCMI Process Units	2-33
2-12	Default-Zero Values: Petroleum Industry	2-34
2-13	10,000 and 100,000 ppmv Screening Value Pegged Emission Rates For SOCMI Process Units	2-36
2-14	10,000 and 100,000 ppmv Screening Value Pegged Emission Rates For the Petroleum Industry	2-37
3-1	Performance Criteria for Portable VOC Detectors	3-6
3-2	Portable VOC Detection Instruments	3-11
3-3	Equipment Leak Emission Sources	3-13
3-4	Example Field Sheets For Equipment Screening Data	3-26
4-1	Calculation Procedures For Leak Rate When Using the Vacuum Method	4-9
4-2	Calculation Procedures For Leak Rate When Using the Blow-Through Method	4-13
4-3	Example GC Calibration Data Sheet	4-20

LIST OF TABLES (Continued)

<u>Table</u>		<u>Page</u>
4-4	Example Data Collection Form For Fugitive Emissions Bagging Test (Blow-Through Method) . . .	4-23
4-5	Example Data Collection Form For Fugitive Emissions Bagging Test (Vacuum Method)	4-24
4-6	Example Drift Test Report Form	4-28
5-1	Summary of Equipment Modifications	5-3
5-2	Control Effectiveness For an LDAR Program At a SOCOMI Process Unit	5-9
5-3	Control Effectiveness For an LDAR Program At a Refinery Process Unit	5-10
5-4	Equations Relating Average Leak Rate to Fraction Leaking at SOCOMI Units	5-46
5-5	Equations Relating Average Leak Rate to Fraction Leaking at Refinery Units	5-47
5-6	Equations Relating Average Leak Rate to Fraction Leaking At Marketing Terminal Units	5-48
5-7	Equations Relating Average Leak Rate to Fraction Leaking At Oil and Gas Production Operating Units	5-50
5-8	Values Used in Example Calculation	5-58
5-9	Example Calculation To Determine the Final Leak Frequency Of SOCOMI Gas Valves In a Monthly Monitoring LDAR Program With a Leak Definition of 10,000 ppmv	5-60

LIST OF FIGURES

<u>Figure</u>		<u>Page</u>
2-1	Overview of Data Collection and Analysis Approaches for Developing Equipment Leak Emissions Inventory	2-4
2-2	SOCMI Correlations Relating Total Organic Compound (TOC) Leak Rate to Screening Value: 0 - 1,000 ppmv	2-28
2-3	SOCMI Correlations Relating Total Organic Compound (TOC) Leak Rate to Screening Value: 1,000 - 1,000,000 ppmv	2-29
2-4	Petroleum Industry Correlations Relating Total Organic Compound (TOC) Leak Rate to Screening Value: 1,000 - 1,000,000 ppmv	2-30
2-5	Petroleum Industry Correlations Relating Total Organic Compound (TOC) Leak Rate to Screening Value: 1,000 - 1,000,000 ppmv	2-31
3-1	Gate Valves	3-17
3-2	Globe Valves	3-18
3-3	Lubricated Plug Valve	3-19
3-4	Ball Valve and Butterfly Valve	3-20
3-5	Weir-Type Diaphragm Valve and Check Valves	3-21
3-6	Centrifugal Pumps	3-23
3-7	Spring-Loaded Relief Valve	3-24
4-1	Sampling Train for Bagging a Source Using the Vacuum Method	4-5
4-2	Equipment Required for the Blow-Through Sampling Technique	4-10
5-1	SOCMI Gas Valve Average Leak Rate Versus Fraction Leaking at Several Leak Definitions	5-11
5-2	SOCMI Light Liquid Valve Average Leak Rate Versus Fraction Leaking at Several Leak Definitions	5-12
5-3	SOCMI Light Liquid Pump Average Leak Rate Versus Fraction Leaking at Several Leak Definitions	5-13

LIST OF FIGURES (Continued)

<u>Figure</u>		<u>Page</u>
5-4	SOCMI Connector Average Leak Rate Versus Fraction Leaking at Several Leak Definitions	5-14
5-5	Refinery Gas Valve Average Leak Rate Versus Fraction Leaking at Several Leak Definitions	5-15
5-6	Refinery Light Liquid Valve Average Leak Rate Versus Fraction Leaking at Several Leak Definitions	5-16
5-7	Refinery Light Liquid Pump Average Leak Rate Versus Fraction Leaking at Several Leak Definitions	5-17
5-8	Refinery Connector Average Leak Rate Versus Fraction Leaking at Several Leak Definitions	5-18
5-9	Marketing Terminal Gas Fittings Average Leak Rate Versus Fraction Leaking at Several Leak Definitions	5-19
5-10	Marketing Terminal Light Liquid Fittings Average Leak Rate Versus Fraction Leaking at Several Leak Definitions	5-20
5-11	Marketing Terminal Gas Others Average Leak Rate Versus Fraction Leaking at Several Leak Definitions	5-21
5-12	Marketing Terminal Light Liquid Others Average Leak Rate Versus Fraction Leaking at Several Leak Definitions	5-22
5-13	Marketing Terminal Light Liquid Pumps Average Leak Rate Versus Fraction Leaking at Several Leak Definitions	5-23
5-14	Marketing Terminal Gas Valves Average Leak Rate Versus Fraction Leaking at Several Leak Definitions	5-24
5-15	Marketing Terminal Light Liquid Valves Average Leak Rate Versus Fraction Leaking at Several Leak Definitions	5-25
5-16	Oil and Gas Production Gas Connectors Average Leak Rate Versus Fraction Leaking at Several Leak Definitions	5-27

LIST OF FIGURES (Continued)

<u>Figure</u>		<u>Page</u>
5-17	Oil and Gas Production Light Oil Connectors Average Leak Rate Versus Fraction Leaking at Several Leak Definitions	5-28
5-18	Oil and Gas Production Water/Oil Connectors Average Leak Rate Versus Fraction Leaking at Several Leak Definitions	5-29
5-19	Oil and Gas Production Gas Flanges Average Leak Rate Versus Fraction Leaking at Several Leak Definitions	5-30
5-20	Oil and Gas Production Light Oil Flanges Average Leak Rate Versus Fraction Leaking at Several Leak Definitions	5-31
5-21	Oil and Gas Production Gas Open-Ended Lines Average Leak Rate Versus Fraction Leaking at Several Leak Definitions	5-32
5-22	Oil and Gas Production Heavy Oil Open-Ended Lines Average Leak Rate Versus Fraction Leaking at Several Leak Definitions	5-33
5-23	Oil and Gas Production Light Oil Open-Ended Lines Average Leak Rate Versus Fraction Leaking at Several Leak Definitions	5-34
5-24	Oil and Gas Production Water/Oil Open-Ended Lines Average Leak Rate Versus Fraction Leaking at Several Leak Definitions	5-35
5-25	Oil and Gas Production Gas Other Average Leak Rate Versus Fraction Leaking at Several Leak Definitions	5-36
5-26	Oil and Gas Production Heavy Oil Other Average Leak Rate Versus Fraction Leaking at Several Leak Definitions	5-37
5-27	Oil and Gas Production Light Oil Other Average Leak Rate Versus Fraction Leaking at Several Leak Definitions	5-38
5-28	Oil and Gas Production Water/Oil Other Average Leak Rate Versus Fraction Leaking at Several Leak Definitions	5-39

LIST OF FIGURES (Continued)

<u>Figure</u>		<u>Page</u>
5-29	Oil and Gas Production Gas Pumps Average Leak Rate Versus Fraction Leaking at Several Leak Definitions	5-40
5-30	Oil and Gas Production Light Oil Pumps Average Leak Rate Versus Fraction Leaking at Several Leak Definitions	5-41
5-31	Oil and Gas Production Gas Valves Average Leak Rate Versus Fraction Leaking at Several Leak Definitions	5-42
5-32	Oil and Gas Production Heavy Oil Valves Average Leak Rate Versus Fraction Leaking at Several Leak Definitions	5-43
5-33	Oil and Gas Production Light Oil Valves Average Leak Rate Versus Fraction Leaking at Several Leak Definitions	5-44
5-34	Oil and Gas Production Water/Oil Valves Average Leak Rate Versus Fraction Leaking at Several Leak Definitions	5-45
5-35	Marketing Terminals Light Liquid Pumps Average Leak Rate Versus Fraction Leaking at Several Leak Definitions	5-55

1.0 INTRODUCTION

This document is an update to the EPA equipment leaks protocol document ("Protocol for Equipment Leak Emission Estimates," EPA-453/R-93-026, June 1993). The purpose of this document is the same as the original protocol document and subsequent revisions- to present standard procedures for estimating mass emissions from equipment leaks. However, this document publishes the results of additional data collection and analysis that has occurred since the original protocol and subsequent revisions were published, and also expands on some of the topics that were covered in the original protocol.

Some of the new features of the updated protocol are:

- (1) New correlation equations, default zero emission rates, and pegged emission rates for the petroleum industry that replace the refinery correlations previously published are presented. The correlations relate screening values obtained using a portable monitoring instrument to mass emissions.
- (2) The document has been expanded to include emission factors for marketing terminals and for oil and gas production operations. The refinery emission factors were not revised due to an unavailability of new data.
- (3) Pegged emission rates for pegged readings at 10,000 ppmv have been added for SOCFI process units.
- (4) Several of the equations in this version of the protocol have been revised by simplifying the symbols to more clearly communicate the concept being conveyed.
- (5) An adjustment has been added to the blow-through method of calculating mass emissions. This adjustment more accurately accounts for the total flow through the bag.

As with the original protocol document, this document presents standard procedures for general use in generating unit-specific emission estimates for permitting and inventories. The document describes methodologies the EPA considers appropriate for development of equipment leak emission estimates. These methodologies are intended to assist States and industry in their efforts to estimate equipment leak emissions.

The updated protocol is divided into five chapters and several appendices. Chapter 2.0 describes how to estimate equipment leak emissions. Chapter 3.0 describes collecting screening data that can be used in the emission estimates. Chapter 4.0 describes collecting unit-specific equipment leak mass emissions data. Chapter 5.0 describes how to estimate the control efficiencies of equipment leak control techniques. The appendices support information contained in the chapters. Each of these chapters and the appendices are briefly described below.

Chapter 2.0 presents the four approaches for estimating total organic emissions from equipment leaks. These approaches are:

- Average Emission Factor Approach;
- Screening Ranges Approach;
- EPA Correlation Approach; and
- Unit-Specific Correlation Approach.

Additionally, several topics that are relevant to estimating equipment leak emissions are addressed. These topics include speciating equipment leak emissions of individual compounds from an equipment piece containing a mixture, using response factors, estimating emissions of volatile organic compounds, estimating emissions of inorganic compounds, and other topics not specifically related to any one of the four approaches.

Chapter 3.0 explains how to perform a screening survey at a process unit. Requirements for the use of a portable monitoring instrument are described. These requirements are based on the EPA Reference Method 21. Additionally, in chapter 3.0, guidance is provided on how to set up a screening program and how to screen different types of equipment.

Chapter 4.0, explains how to collect equipment leak rate data (bagging data) by enclosing individual equipment in a "bag" and measuring mass emissions. These data can be used to develop unit-specific leak rate/screening value correlations. Chapter 4.0 details the rigorous steps that need to be followed when collecting the bagging data to generate unit-specific correlations. These steps are intended to ensure that the data are of high quality.

Chapter 5.0, explains how to estimate the control efficiency of equipment leak emission control techniques. The two primary control techniques for reducing equipment leak emissions are (1) equipment modifications (such as replacing a standard valve with a sealless type) and (2) implementing a leak detection and repair (LDAR) program. Control efficiencies for different equipment leak modifications are summarized, and an approach for estimating the control efficiency of any LDAR program is provided.

Appendices A through G provide additional information supporting the material in the chapters. Appendix A contains detailed example calculations using the approaches described in chapter 2.0. Appendix B documents how the SOCFI correlations and emission factors were revised. Appendix B also serves as a demonstration of how data can be analyzed to develop unit-specific correlations. Appendix C presents the rationale for the development of the petroleum industry correlations, as well as the background for the development of marketing terminal and oil and gas production operations emission factors. Appendix D summarizes available data on response factors. Appendix E provides guidance on how to collect representative screening data for connectors. Appendix F contains a copy of the EPA Reference Method 21. Finally, appendix G demonstrates how LDAR control efficiencies presented in chapter 5.0 were calculated.

2.0. DEVELOPMENT OF EQUIPMENT LEAK EMISSION ESTIMATES

2.1 INTRODUCTION

The purpose of this chapter is to describe the methods for estimating mass emissions from equipment leaks in a chemical processing unit. Four approaches for estimating equipment leak emissions are presented:

Approach 1: Average Emission Factor Approach;

Approach 2: Screening Ranges Approach;

Approach 3: EPA Correlation Approach; and

Approach 4: Unit-Specific Correlation Approach.

General information on these approaches is presented in section 2.2, and detailed information on applying each of the approaches is presented in section 2.3. Included in section 2.3 are emission factors and leak rate/screening value correlations for use in estimating emissions from equipment leaks in the petroleum industry and the synthetic organic chemical manufacturing industry (SOCMI). The SOCMI emission factors and correlations were revised and introduced in the 1993 update of this document. The refinery correlations that have been revised and expanded to include the entire petroleum industry are introduced in this document. Additionally, emission factors for marketing terminals are introduced in this document. Emission factors for gas plants that have been updated and expanded to include oil and gas production operations are also introduced in this document. The procedures in this document estimate emissions of total organic compounds (TOC's). However, special procedures are also described for the purpose of estimating volatile organic compounds (VOC's). As defined by the EPA, VOC's

include all organic compounds except those specifically excluded by the EPA due to negligible photochemical activity.

After the four approaches have been discussed, topics that are not specifically related to any particular approach, but are relevant to how equipment leak emissions are estimated, are addressed in section 2.4. These topics include:

- Estimating emissions of individual compounds within a mixture;
- Using response factors when estimating emissions;
- Considerations regarding the monitoring instrument used;
- Estimating emissions of equipment not screened when other equipment have been screened;
- Using screening data collected at different times;
- Estimating VOC emissions from equipment containing organic compounds excluded from the EPA's classification of TOC's; and
- Estimating emissions from equipment containing inorganic compounds.

Appendices A through E contain supporting documentation for the material presented in this chapter. Appendix A contains detailed example calculations that demonstrate the four approaches for estimating equipment leak emissions, as well as the topics discussed in section 2.4. Appendix B presents details on how unit-specific correlations can be developed, and also presents background information on the revision of the SOCM1 correlations and emission factors. Appendix C presents background information on the development of average emission factors and correlation equations for the petroleum industry. Appendix D offers a detailed listing of available response factors. Appendix E contains information on the minimum number of connectors in a process unit that must be screened in order to obtain a representative sample.

2.2 GENERAL INFORMATION ON THE APPROACHES FOR ESTIMATING EQUIPMENT LEAK EMISSIONS

This section presents general information on the four approaches for estimating equipment leak emissions. Each approach is briefly described, and data requirements for each are summarized. Additionally, background information is presented to provide an historical overview of data collection and analysis on emissions of VOC's from equipment leaks.

2.2.1 Equipment Leak Emission Estimation Approaches

The four approaches described here can be used by any chemical-handling facility to develop an inventory of TOC or VOC emissions from equipment leaks. The approaches, in order of increasing refinement, are: Average Emission Factor Approach, Screening Ranges Approach, EPA Correlation Approach, and Unit-Specific Correlation Approach.

In general, the more refined approaches require more data and provide more accurate emission estimates for a process unit. In the Average Emission Factor Approach and the Screening Ranges Approach, emission factors are combined with equipment counts to estimate emissions. To estimate emissions with the EPA Correlation Approach, measured concentrations (screening values) for all equipment are individually entered into general correlations developed by the EPA. In the Unit-Specific Correlation Approach, screening and leak rate data are measured for a select set of individual equipment components and then used to develop unit-specific correlations. Screening values for all components are then entered into these unit-specific correlations to estimate emissions.

Figure 2-1 is an overview of the data collection and analysis required to apply each of the approaches. As can be seen from this figure, all of the approaches require an accurate count of equipment components by type of equipment (i.e., valves, pumps, connectors, etc.). Additionally, for some of the equipment types, the count must be further described by service (i.e., heavy liquid, light liquid, and gas).

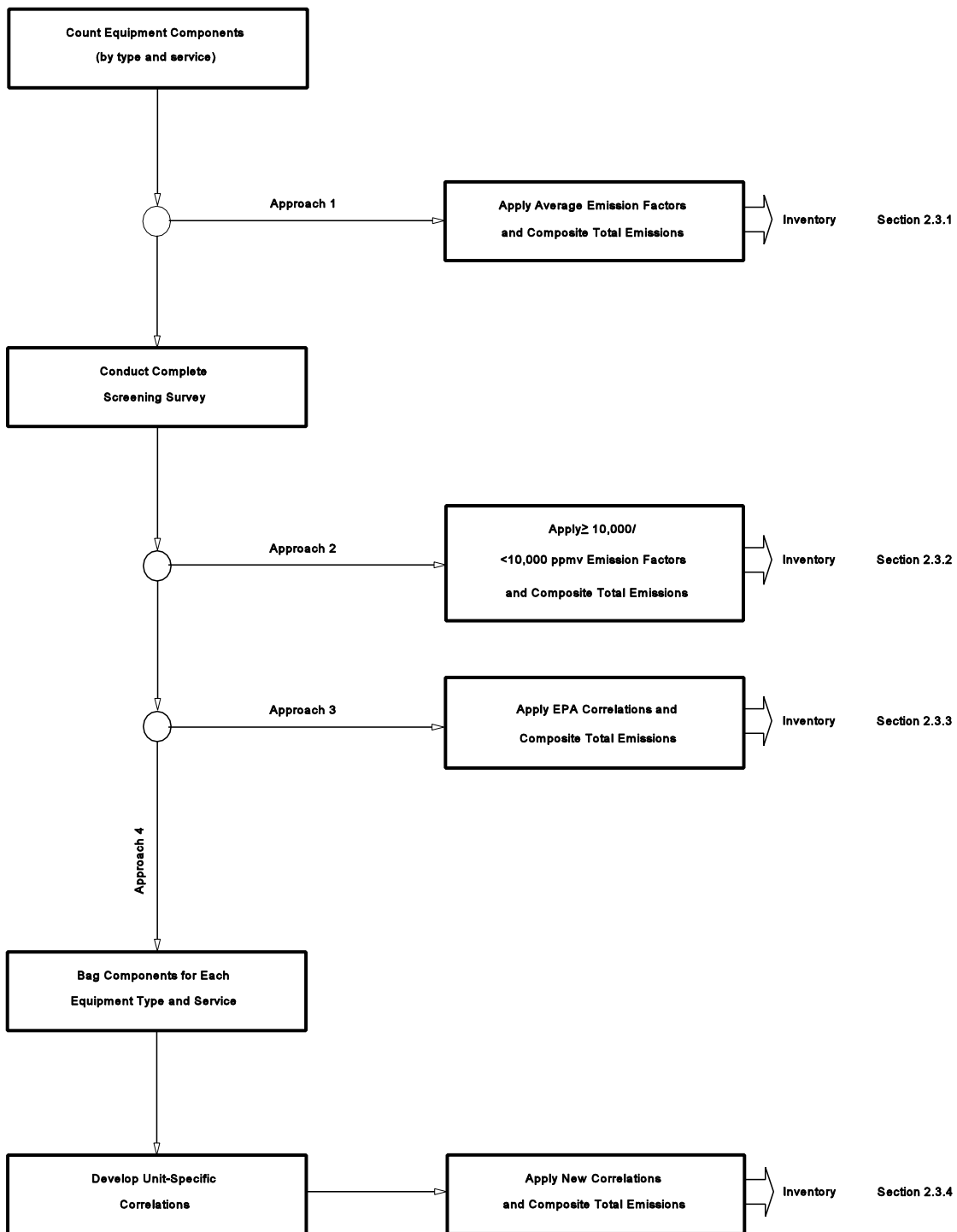

Figure 2-1. Overview of Data Collection and Analysis Approaches for Developing Equipment Leak Emissions Inventory

Except for the Average Emission Factor Approach, all of the approaches require screening data. Screening data are collected by using a portable monitoring instrument to sample air from potential leak interfaces on individual pieces of equipment. A screening value is a measure of the concentration of leaking compounds in the ambient air that provides an indication of the leak rate from an equipment piece, and is measured in units of parts per million by volume (ppmv). The procedures for collecting screening data are presented in chapter 3.0.

In addition to equipment counts and screening data, the Unit-Specific Correlation Approach requires bagging data. Bagging data consist of screening values and their associated measured leak rates. A leak rate is measured by enclosing an equipment piece in a bag to determine the actual mass emission rate of the leak. The screening values and measured leak rates from several pieces of equipment are used to develop a unit-specific correlation. The resulting leak rate/screening value correlation predicts the mass emission rate as a function of the screening value. Procedures for collecting bagging data are described in detail in chapter 4.0.

Each of the approaches are applicable to any chemical-handling facility. However, the EPA has developed more than one set of emission factors and correlations, and the type of process unit being considered governs which set must be used to estimate emissions. Historical data collection on emissions from equipment leaks in SOCFI, refineries, marketing terminals and oils and gas production operations have yielded emission factors and correlations for these source categories. Emission factors and correlations for other source categories have not been developed.

For process units in source categories for which emission factors and/or correlations have not been developed, the factors and/or correlations already developed can be utilized. However, appropriate evidence should indicate that the existing emission factors and correlations are applicable to the source category in question. Criteria for determining the appropriateness of

applying existing emission factors and correlations to another source category may include one or more of the following:

(1) process design, (2) process operation parameters (i.e., pressure and temperature), (3) types of equipment used, and (4) types of material handled. For example, in most cases, SOCFI emission factors and correlations are applicable for estimating equipment leak emissions from the polymer and resin manufacturing industry. This is because, in general, these two industries have comparable process design and comparable process operation, they use the same types of equipment, and they tend to use similar feedstock.

2.2.2 Overview of Equipment Leak Data Collection

Data on equipment leak emissions of organic compounds have been collected from refineries, marketing terminals, oil and gas production operations, and SOCFI process units. Emission factors and correlations have been developed for the following equipment types: valves, pumps, compressors, pressure relief valves, connectors, flanges, and open-ended lines. An "others" category has also been developed for the petroleum industry. For sampling connections, an average emission factor has been developed that estimates the typical amount of material purged when a sample is collected. A brief history of the development of these factors and correlations is presented below.

2.2.2.1 Refinery Assessment Study.^{1,2} In the late 1970s, the EPA initiated the Petroleum Refinery Assessment Study, and equipment leak data from 13 refineries were collected. In this study, equipment was screened and the majority of sources that had screening values over 200 ppmv were bagged. Bagged equipment emission rates were reported as non-methane organic compound emission rates. Average emission factors and correlations for each equipment type were developed based on the screening and bagging data collected in this study.

The Refinery Assessment Study included an investigation of possible correlations between equipment leaks and process variables. The only process variables found to correlate with mass emission rates in a statistically significant manner were

(1) the phase of the process stream (service), and (2) the relative volatility of liquid streams. This finding led to the separation of data for valves, pumps, and pressure relief valves by type of service. Three service categories were defined:

- Gas/vapor - material in a gaseous state at operating conditions;
- Light liquid - material in a liquid state in which the sum of the concentration of individual constituents with a vapor pressure over 0.3 kilopascals (kPa) at 20 °C is greater than or equal to 20 weight percent; and
- Heavy liquid - not in gas/vapor service or light liquid service.

2.2.2.2 Gas Plant Studies.³ A total of six gas plants were screened in two studies: Four were screened by the EPA and two by the American Petroleum Institute. Average emission factors were developed, and information on the percentage of equipment with screening values equal to or greater than 10,000 ppmv was presented. The average factors include emissions of ethane and methane, which are hydrocarbons but are not classified as VOC's.

2.2.2.3 Revised Petroleum Industry Correlations and Emission Factors. During the early-1990's, new petroleum industry equipment leak bagging data were collected and analyzed. The Western States Petroleum Association (WSPA) and the American Petroleum Institute (API) jointly commissioned the 1994 refinery equipment leak report⁴ to evaluate fugitive emissions collected from five petroleum refineries. The API also commissioned the 1993 marketing terminal equipment leak report,⁵ which included bagging data from three marketing terminals, and, along with the Gas Research Institute (GRI), jointly commissioned the 1993 and 1995 oil and gas production operations reports, which included bagging data from 24 facilities.^{6,7} In addition to the bagging data, screening data were also collected from 17 marketing terminals⁸ and 24 oil and gas production facilities.^{6,7} Data from gas/vapor, light liquid, and/or heavy liquid streams were collected for these studies from non-flanged connectors, flanges, open-ended lines, pumps, valves, instruments, loading arms,

pressure relief valves, stuffing boxes, vents, compressors, dump lever arms, diaphragms, drains, hatches, meters, and polished rods.

A specific goal of the above studies was to collect high quality data to enhance or replace the previously published refinery correlations. As a result of the analyses discussed in appendix C, the bagging data collected from refineries, marketing terminals, and oil and gas production facilities during the early-1990's were combined to replace the previously published refinery correlations with correlations applicable to the entire petroleum industry. In addition, the new correlations apply across all services for a given equipment type. The previously published refinery correlations were specific to service and equipment.

The screening data were used to develop average emission factors for marketing terminals and for oil and gas production operations. The average emission factors for oil and gas production operations replace the gas plant factors published in previous versions of this document and apply to light crude, heavy crude, gas plant, gas production and off shore facilities. No new screening data were available for refineries, therefore the previously published refinery average emission factors remain unchanged in this version of the protocol. Appendix C contains more detailed information on how the new petroleum industry correlations, marketing terminal emission factors, and oil and gas production operations emission factors were developed.

2.2.2.4 Original SOCFI Average Emission Factors and Correlations. In 1980, two studies were coordinated by the EPA to collect data from SOCFI process units. These studies were the 24-Unit Study,⁹ and the Six-Unit Maintenance Study.¹⁰ In the 24-Unit Study, screening data were obtained from equipment containing organic compounds at 24 individual chemical process units representing a cross-section of the SOCFI. In the Six-Unit Maintenance Study, bagging data were collected from six of the process units within the 24-Unit Study to determine the effect of maintenance on equipment leak emissions. Most of the bagging

data were collected from equipment with screening values above 1,000 ppmv. As part of the Six-Unit Maintenance Study, correlations were developed for light liquid pumps, gas valves, and light liquid valves.

The original SOCFI average emission factors were first presented in the document "Fugitive Emission Sources of Organic Compounds--Additional Information on Emissions, Emission Reductions, and Costs."⁶ This document is referred to as the Fugitive Emissions Additional Information Document (AID). In the Fugitive Emissions AID, the data from the Refinery Assessment Study were further analyzed to develop "leak/no leak" emission factors. (A "leak" was defined as a screening value greater than or equal to 10,000 ppmv.) With the exception of the factor for gas valves, the original SOCFI average emission factors were developed using (1) the leak/no-leak emission factors developed from the Refinery Assessment Study data, and (2) the leak frequencies from the SOCFI 24-Unit Study screening value data set. This approach was based on statistical comparisons that indicated that the most significant characteristic that distinguished equipment in SOCFI facilities from that in refineries was not the leak rate for a given screening value, but rather the fraction of equipment that had screening values greater than or equal to 10,000 ppmv.

Thus, the following equation was used to calculate the original SOCFI average emission factors:

$$\text{SOCFI Average Factor} = (F \times \text{RLF}) + (1 - F) \times \text{RNLF}$$

where:

F = Fraction of sources from the 24-Unit Study that screened greater than or equal to 10,000 ppmv;

RLF = Refinery leaking emission factor; and

RNLF = Refinery non-leaking emission factor.

For gas valves, the previously collected data suggested that for a given screening value the leak rate at a SOCFI facility was

not statistically equivalent to the leak rate at a refinery. Therefore, data from the Six-Unit Maintenance Study were used to develop the gas valve average emission factor.

2.2.2.5 Revised SOCFI Emission Factors and Correlations. In 1987 and 1988, screening data were obtained from 19 ethylene oxide and butadiene producers, and, in 1990, bagging data were collected from 16 of these process units. Screening and bagging data were collected from light liquid pumps, gas valves, light liquid valves, and connectors. A specific goal of the program was to bag equipment that had screening values less than 1,000 ppmv. The bagging data were combined with bagging data previously collected in the Six-Unit Maintenance Study, and this combined bagging data set was used to revise the SOCFI correlations. Likewise, the new screening data were combined with screening data previously collected in the 24-Unit Study, and this combined screening data set was used with the revised correlations to generate new SOCFI emission factors.

Appendix B.2 contains more detailed information on how the revised SOCFI correlations and emission factors were developed.

2.3 APPROACHES FOR ESTIMATING EQUIPMENT LEAK EMISSIONS

In this section, each of the approaches for estimating equipment leak emissions are discussed. The description of each approach focuses on the basic method for estimating TOC emissions. Each of the approaches are demonstrated in example calculations contained in appendix A. Special topics at the end of the chapter have been included to address how to estimate VOC emissions when some of the organic compounds in the stream are not classified as VOC's and also how to speciate emissions for individual chemicals from equipment containing a mixture.

2.3.1 Average Emission Factor Approach

One accepted approach for estimating emissions allows use of average emission factors developed by the EPA in combination with unit-specific data that are relatively simple to obtain. These data include: (1) the number of each type of component in a unit (valve, connector, etc.), (2) the service each component is in (gas, light liquid, or heavy liquid), (3) the TOC concentration

of the stream (and VOC or HAP concentrations if speciation is to be performed), and (4) the time period each component was in that service. The average emission factors for SOCFI process units, refineries, marketing terminals, and oil and gas production operations are presented in tables 2-1, 2-2, 2-3, and 2-4 respectively. The SOCFI, marketing terminal, and oil and gas production operations average emission factors predict total organic compound emission rates, whereas the refinery average factors predict non-methane organic compound emission rates. Note that limited data has been collected on the leak rate of agitators, and, until additional data are collected for emissions from agitator seals, the average factor for light liquid pump seals can be used to estimate emissions from agitators.

Although the average emission factors are in units of kilogram per hour per individual source, it is important to note that these factors are most valid for estimating emissions from a population of equipment. The average factors are not intended to be used for estimating emissions from an individual piece of equipment over a short time period (i.e., 1 hour).

To estimate emissions using the Average Emission Factor Approach, the concentration of TOC in weight fraction within the equipment is needed because equipment with higher TOC concentrations tend to have higher TOC leak rates. When using the Average Emission Factor Approach, equipment should be grouped into "streams" where all the equipment within the stream have approximately the same TOC weight fraction.

To apply the average emission factors, use the following equation to estimate TOC mass emissions from all of the equipment in a stream of a given equipment type:

$$E_{\text{TOC}} = F_A \times W_{\text{TOC}} \times N$$

where:

E_{TOC} = Emission rate of TOC from all equipment in the stream of a given equipment type (kg/hr);

TABLE 2-1. SOCMI AVERAGE EMISSION FACTORS

Equipment type	Service	Emission factor ^a (kg/hr/source)
Valves	Gas	0.00597
	Light liquid	0.00403
	Heavy liquid	0.00023
Pump seals ^b	Light liquid	0.0199
	Heavy liquid	0.00862
Compressor seals	Gas	0.228
Pressure relief valves	Gas	0.104
Connectors	All	0.00183
Open-ended lines	All	0.0017
Sampling connections	All	0.0150

^aThese factors are for total organic compound emission rates.

^bThe light liquid pump seal factor can be used to estimate the leak rate from agitator seals.

TABLE 2-2. REFINERY AVERAGE EMISSION FACTORS^a

Equipment type	Service	Emission factor (kg/hr/source) ^b
Valves	Gas	0.0268
	Light liquid	0.0109
	Heavy liquid	0.00023
Pump seals ^c	Light liquid	0.114
	Heavy liquid	0.021
Compressor seals	Gas	0.636
Pressure relief valves	Gas	0.16
Connectors	All	0.00025
Open-ended lines	All	0.0023
Sampling connections	All	0.0150

^aSource: Reference 2.

^bThese factors are for non-methane organic compound emission rates.

^cThe light liquid pump seal factor can be used to estimate the leak rate from agitator seals.

TABLE 2-3. MARKETING TERMINAL AVERAGE EMISSION FACTORS

Equipment type	Service	Emission factor (kg/hr/source) ^a
Valves	Gas	1.3E-05
	Light Liquid	4.3E-05
Pump seals	Gas	6.5E-05
	Light Liquid	5.4E-04
Others (compressors and others) ^b	Gas	1.2E-04
	Light Liquid	1.3E-04
Fittings (connectors and flanges) ^c	Gas	4.2E-05
	Light Liquid	8.0E-06

^aThese factors are for total organic compound emission rates (including non-VOC's such as methane and ethane).

^bThe "other" equipment type should be applied for any equipment type other than fittings, pumps, or valves.

^c"Fittings" were not identified as flanges or non-flanged connectors; therefore, the fitting emissions were estimated by averaging the estimates from the connector and the flange correlation equations.

TABLE 2-4. OIL AND GAS PRODUCTION OPERATIONS AVERAGE EMISSION FACTORS (kg/hr/source)

Equipment Type	Service ^a	Emission Factor (kg/hr/source) ^b
Valves	Gas	4.5E-03
	Heavy Oil	8.4E-06
	Light Oil	2.5E-03
	Water/Oil	9.8E-05
Pump seals	Gas	2.4E-03
	Heavy Oil	NA
	Light Oil	1.3E-02
	Water/Oil	2.4E-05
Others ^c	Gas	8.8E-03
	Heavy Oil	3.2E-05
	Light Oil	7.5E-03
	Water/Oil	1.4E-02
Connectors	Gas	2.0E-04
	Heavy Oil	7.5E-06
	Light Oil	2.1E-04
	Water/Oil	1.1E-04
Flanges	Gas	3.9E-04
	Heavy Oil	3.9E-07
	Light Oil	1.1E-04
	Water/Oil	2.9E-06
Open-ended lines	Gas	2.0E-03
	Heavy Oil	1.4E-04
	Light Oil	1.4E-03
	Water/Oil	2.5E-04

^aWater/Oil emission factors apply to water streams in oil service with a water content greater than 50%, from the point of origin to the point where the water content reaches 99%. For water streams with a water content greater than 99%, the emission rate is considered negligible.

^bThese factors are for total organic compound emission rates (including non-VOC's such as methane and ethane) and apply to light crude, heavy crude, gas plant, gas production, and off shore facilities. "NA" indicates that not enough data were available to develop the indicated emission factor.

^cThe "other" equipment type was derived from compressors, diaphragms, drains, dump arms, hatches, instruments, meters, pressure relief valves, polished rods, relief valves, and vents. This "other" equipment type should be applied for any equipment type other than connectors, flanges, open-ended lines, pumps, or valves.

F_A = Applicable average emission factor for the equipment type (kg/hr/source);

FOR REFINERIES ONLY: The emission factor " F_A " must be adjusted to account for all organic compounds in the stream because the refinery factors are only valid for non-methane organic compounds (percents up to a maximum of 10 percent by weight methane are permitted):

$$F_A = F_A \times \frac{WF_{TOC}}{WF_{TOC} - WF_{methane}} ;$$

WF_{TOC} = Average weight fraction of TOC in the stream;

$WF_{methane}$ = Average weight fraction of methane in the stream; and

N = Number of pieces of equipment of the applicable equipment type in the stream.

Note that the emission factor " F_A " is defined differently for refineries than for SOCOMI, marketing terminals, or oil and gas production operations when calculating TOC mass emissions. It is necessary to adjust the " F_A " term when applied to refineries, because when the refinery factors were developed, the methane was subtracted out of the organic total. Adjusting the " F_A " term for refineries is a way to correct for this. Two guidelines when correcting the " F_A " term when applied to refineries are as follows:

- The correction should only be applied to equipment containing a mixture of organics and methane; and
- The maximum correction for the methane weight fraction should not exceed 0.10, even if the equipment contains greater than 10 weight percent methane. (This reflects that equipment in the Refinery Assessment Study^{1,2} typically contained 10 weight percent or less methane).

Thus, at a SOCOMI process unit, if there were 100 gas valves in a stream containing, on average, 90 weight percent TOC and 10 weight percent water vapor, emissions would be calculated as follows:

$$\begin{aligned}
E_{\text{TOC}} &= F_A \times W_{\text{F}_{\text{TOC}}} \times N \\
&= 0.00597 \text{ kg/hr/gas valve} \times 0.9 \times 100 \text{ gas valves} \\
&= 0.54 \text{ kg/hr of VOC from gas valves in the stream}
\end{aligned}$$

At a refinery, if there were 100 gas valves in a stream that, on average, contained 80 weight percent non-methane TOC, 10 weight percent water vapor, and 10 weight percent methane (thus, the TOC weight percent would be 90), emissions would be calculated using the above equation as follows:

$$\begin{aligned}
E_{\text{TOC}} &= F_A \times \frac{W_{\text{F}_{\text{TOC}}}}{W_{\text{F}_{\text{TOC}}} - W_{\text{F}_{\text{methane}}}} \times W_{\text{F}_{\text{TOC}}} \times N \\
&= 0.0268 \text{ kg/hr/gas valve} \times (0.9/0.9-0.1) \times 0.9 \times \\
&\quad 100 \text{ gas valves} \\
&= 2.71 \text{ kg/hr of VOC from gas valves in the stream}
\end{aligned}$$

If there are several streams at a process unit, the total TOC emission rate for an equipment type is the sum of emissions from each of the streams. The total emission rates for all of the equipment types are summed to generate the process unit total TOC emission rate from leaking equipment.

Assuming all of the organic compounds in the stream are classified as VOC's, the total VOC emission for each stream is calculated as the sum of TOC emissions associated with each specific equipment type in the stream. Section 2.4.6 discusses an adjustment that can be made to predict the VOC emission rate if some of the organic compounds in the stream are not classified as VOC's (such as methane and ethane).

As mentioned earlier, the average emission factors are not intended to provide an accurate estimate of the emission rate from a single piece of equipment. Rather, the average factors are more appropriately applied to the estimation of emissions from populations of equipment. Data indicate that the range of possible leak rates from individual pieces of equipment spans

several orders of magnitude. As a result, the majority of total emissions from a population of equipment at any given time will normally occur from a small percentage of the total equipment. The average emission factors account for the span of possible leak rates, but, as a result, they are not necessarily an accurate indication of the mass emission rate from an individual piece of equipment.

Furthermore, the average emission factors do not reflect different site-specific conditions among process units within a source category. Site-specific factors can have considerable influence on leak rates from equipment. Nevertheless, in the absence of screening data, the average emission factors do provide an indication of equipment leak emission rates from equipment in a process unit.

2.3.2 Screening Ranges Approach

The Screening Ranges Approach (formerly known as the leak/no-leak approach) offers some refinement over the Average Emission Factor Approach, thereby allowing some adjustment for individual unit conditions and operation. This approach is included in this section primarily to aid in the analysis of old datasets which were collected for older regulations that used 10,000 ppmv as the leak definition. This approach and the other two remaining approaches require that screening data be collected for the equipment in the process unit. The screening data are an indication of leak rates. When applying this approach, it is assumed that components having screening values greater than 10,000 ppmv have a different average emission rate than components with screening values less than 10,000 ppmv.

This approach may be applied when screening data are available as either "greater than or equal to 10,000 ppmv" or as "less than 10,000 ppmv." Emission factors for SOCFI, refineries, marketing terminals, and oil and gas production operations for these two ranges of screening values are presented in tables 2-5, 2-6, and 2-7, and 2-8, respectively. As with the average factors, the SOCFI, marketing terminal, and oil and gas production operations screening range factors predict total

TABLE 2-5. SOCFI SCREENING RANGES EMISSION FACTORS

Equipment type	Service	≥10,000 ppmv Emission factor (kg/hr/source) ^a	<10,000 ppmv Emission factor (kg/hr/source) ^a
Valves	Gas	0.0782	0.000131
	Light liquid	0.0892	0.000165
	Heavy liquid	0.00023	0.00023
Pump seals ^b	Light liquid	0.243	0.00187
	Heavy liquid	0.216	0.00210
Compressor seals	Gas	1.608	0.0894
Pressure relief valves	Gas	1.691	0.0447
Connectors	All	0.113	0.0000810
Open-ended lines	All	0.01195	0.00150

^aThese factors are for total organic compound emission rates.

^bThe light liquid pump seal factors can be applied to estimate the leak rate from agitator seals.

TABLE 2-6. REFINERY SCREENING RANGES EMISSION FACTORS^a

Equipment type	Service	≥10,000 ppmv Emission factor (kg/hr/source) ^b	<10,000 ppmv Emission factor (kg/hr/source) ^b
Valves	Gas	0.2626	0.0006
	Light liquid	0.0852	0.0017
	Heavy liquid	0.00023	0.00023
Pump seals ^c	Light liquid	0.437	0.0120
	Heavy liquid	0.3885	0.0135
Compressor seals	Gas	1.608	0.0894
Pressure relief valves	Gas	1.691	0.0447
Connectors	All	0.0375	0.00006
Open-ended lines	All	0.01195	0.00150

^aSource: Reference 6.

^bThese factors are for non-methane organic compound emission rates.

^cThe light liquid pump seal factors can be applied to estimate the leak rate from agitator seals.

TABLE 2-7. MARKETING TERMINAL SCREENING RANGES EMISSION FACTORS

Equipment type	Service	≥10,000 ppmv Emission factor (kg/hr/source) ^a	<10,000 ppmv Emission factor (kg/hr/source) ^a
Valves	Gas	NA	1.3E-05
	Light Liquid	2.3E-02	1.5E-05
Pump seals	Light liquid	7.7E-02	2.4E-04
Other (compressors and others) ^b	Gas	NA	1.2E-04
	Light liquid	3.4E-02	2.4E-05
Fittings (connectors and flanges) ^c	Gas	3.4E-02	5.9E-06
	Light liquid	6.5E-03	7.2E-06

^aThese factors are for total organic compound emission rates (including non-VOC's such as methane and ethane). "NA" indicates that not enough data were available to develop the indicated emission factor.

^bThe "other" equipment type should be applied for any equipment type other than fittings, pumps, or valves.

^c"Fittings" were not identified as flanges or connectors; therefore, the fitting emissions were estimated by averaging the estimates from the connector and the flange correlation equations.

TABLE 2-8. OIL AND GAS PRODUCTION OPERATIONS SCREENING RANGES
EMISSION FACTORS

Equipment type	Service ^b	≥10,000 ppmv Emission factor (kg/hr/source) ^a	<10,000 ppmv Emission factor (kg/hr/source) ^a
Valves	Gas	9.8E-02	2.5E-05
	Heavy Oil	NA	8.4E-06
	Light Oil	8.7E-02	1.9E-05
	Water/Oil	6.4E-02	9.7E-06
Pump seals	Gas	7.4E-02	3.5E-04
	Heavy Oil	NA	NA
	Light Oil	1.0E-01	5.1E-04
	Water/Oil	NA	2.4E-05
Others ^c	Gas	8.9E-02	1.2E-04
	Heavy Oil	NA	3.2E-05
	Light Oil	8.3E-02	1.1E-04
	Water/Oil	6.9E-02	5.9E-05
Connectors	Gas	2.6E-02	1.0E-05
	Heavy Oil	NA	7.5E-06
	Light Oil	2.6E-02	9.7E-06
	Water/Oil	2.8E-02	1.0E-05
Flanges	Gas	8.2E-02	5.7E-06
	Heavy Oil	NA	3.9E-07
	Light Oil	7.3E-02	2.4E-06
	Water/Oil	NA	2.9E-06
Open-ended lines	Gas	5.5E-02	1.5E-05
	Heavy Oil	3.0E-02	7.2E-06
	Light Oil	4.4E-02	1.4E-05
	Water/Oil	3.0E-02	3.5E-06

^aThese factors are for total organic compound emission rates (including non-VOC's such as methane and ethane) and apply to light crude, heavy crude, gas plant, gas production, and offshore facilities. "NA" indicates that not enough data were available to develop the indicated emission factor.

^bWater/Oil emission factors apply to water streams in oil service with a water content greater than 50%, from the point of origin to the point where the water content reaches 99%. For water streams with a water content greater than 99%, the emission rate is considered negligible.

^cThe "other" equipment type was derived from compressors, diaphragms, drains, dump arms, hatches, instruments, meters, pressure relief valves, polished rods, relief valves, and vents. This "other" equipment type should be applied for any equipment type other than connectors, flanges, open-ended lines, pumps, or valves.

organic compound emissions, whereas the refinery screening range factors predict non-methane organic compound emissions. Note that there are not screening range factors for sampling connections because emissions from sampling connections occur when the line is purged, and, thus, are independent of any screening value. Also, as with the average factors, the screening range factors for light liquid pumps can be applied to agitators.

The Screening Ranges Approach is applied in a similar manner as the Average Emission Factor Approach in that equipment counts are multiplied by the applicable emission factor. Also, for refineries, the screening range emission factors must be adjusted for methane in the equipment because when the refinery factors were developed, the methane was subtracted out of the organic total.

To calculate TOC emissions using the Screening Ranges Approach, the following equation is used:

$$E_{\text{TOC}} = (F_{\text{G}} \times N_{\text{G}}) + (F_{\text{L}} \times N_{\text{L}})$$

where:

E_{TOC} = TOC emission rate for an equipment type (kg/hr);

F_{G} = Applicable emission factor for sources with screening values greater than or equal to 10,000 ppmv (kg/hr/source);

FOR REFINERIES ONLY: The emission factor " F_{G} " must be adjusted to account for all organic compounds in the stream because the refinery factors are only valid for non-methane organic compounds (percents up to a maximum of 10 percent by weight methane are permitted):

$$F_{\text{G}} = F_{\text{G}} \times \frac{W_{\text{P}_{\text{TOC}}}}{W_{\text{P}_{\text{TOC}}} - W_{\text{P}_{\text{methane}}}} ;$$

$W_{\text{P}_{\text{TOC}}}$ = Average weight percent of TOC in the stream;

- WP_{methane} = Average weight percent of methane in the stream;
- N_G = Equipment count (specific equipment type) for sources with screening values greater than or equal to 10,000 ppmv;
- F_L = Applicable emission factor for sources with screening values less than 10,000 ppmv (kg/hr/source)

FOR REFINERIES ONLY: The emission factor " F_L " must be adjusted to account for all organic compounds in the stream because the refinery factors are only valid for non-methane organic compounds (percents up to a maximum of 10 percent by weight methane are permitted):

$$F_L = F_L \times \frac{WP_{\text{TOC}}}{WP_{\text{TOC}} - WP_{\text{methane}}} ; \text{ and}$$

- N_L = Equipment count (specific equipment type) for sources with screening values less than 10,000 ppmv.

Assuming all of the organic compounds in the stream are classified as VOC's, the total VOC emission for each stream is calculated as the sum of TOC emissions associated with each specific equipment type in the stream. Section 2.4.6 discusses an adjustment that can be made to predict the VOC emission rate if some of the organic compounds in the stream are not classified as VOC's (such as methane and ethane).

The screening range emission factors are a better indication of the actual leak rate from individual equipment than the average emission factors. Nevertheless, available data indicate that measured mass emission rates can vary considerably from the rates predicted by use of these factors.

2.3.3 EPA Correlation Approach

This approach offers an additional refinement to estimating emissions from equipment leaks by providing an equation to predict mass emission rate as a function of screening value for a particular equipment type. Correlations developed by the EPA relating screening values to mass emission rates for SOCFI

process units and for petroleum industry process units are presented in tables 2-9 and 2-10, respectively. Correlations for the petroleum industry apply to refineries, marketing terminals and oil and gas production operations. Figures 2-2 through 2-5 plot the correlations. Both the SOCFI and petroleum industry correlations predict total organic compound emission rates. Appendix B.1 contains additional information on the general development of correlation equations. Additionally, appendix B.2 contains information about the development of the SOCFI correlations and appendix C contains information about the development of the petroleum industry correlations.

The EPA Correlation Approach is preferred when actual screening values are available. Correlations can be used to estimate emissions for the entire range of non-zero screening values, from the highest potential screening value to the screening value that represents the minimum detection limit of the monitoring device. This approach involves entering the non-zero, non-pegged screening value into the correlation equation, which predicts the TOC mass emission rate based on the screening value. Default zero emission rates are used for screening values of zero ppmv and pegged emission rates are used for "pegged" screening values (the screening value is beyond the upper limit measured by the portable screening device).

Correlations for SOCFI are available for (1) gas valves; (2) light liquid valves; (3) connectors; and (4) light liquid pump seals. Correlations for the petroleum industry are available for (1) valves; (2) connectors; (3) pumps; (4) flanges; (5) open-ended lines; and (6) "others" (derived from instruments, loading arms, pressure relief valves, stuffing boxes, and vents).

Limited bagging data for compressors and pressure relief devices have been obtained at SOCFI plants. However, because statistical tests performed as part of the Refinery Assessment Study² indicated that emissions from light liquid pumps, compressors, and pressure relief valves could be expressed with a single correlation, until additional data are collected, the SOCFI equation for light liquid pump seals can be applied to

TABLE 2-9. SOCMI LEAK RATE/SCREENING VALUE CORRELATIONS

Equipment type	Correlation ^{a,b}
Gas valves	Leak rate (kg/hr) = $1.87E-06 \times (SV)^{0.873}$
Light liquid valves	Leak rate (kg/hr) = $6.41E-06 \times (SV)^{0.797}$
Light liquid pumps ^c	Leak rate (kg/hr) = $1.90E-05 \times (SV)^{0.824}$
Connectors	Leak rate (kg/hr) = $3.05E-06 \times (SV)^{0.885}$

^aSV = Screening value in ppmv.

^bThese correlations predict total organic compound emission rates.

^cThe correlation for light liquid pumps can be applied to compressor seals, pressure relief valves, agitator seals, and heavy liquid pumps.

TABLE 2-10. PETROLEUM INDUSTRY LEAK RATE/SCREENING VALUE CORRELATIONS^a

Equipment type/service	Correlation ^{b,c}
Valves/all	Leak rate (kg/hr) = $2.29E-06 \times (SV)^{0.746}$
Pump seals/all	Leak rate (kg/hr) = $5.03E-05 \times (SV)^{0.610}$
Others ^d	Leak rate (kg/hr) = $1.36E-05 \times (SV)^{0.589}$
Connectors/all	Leak rate (kg/hr) = $1.53E-06 \times (SV)^{0.735}$
Flanges/all	Leak rate (kg/hr) = $4.61E-06 \times (SV)^{0.703}$
Open-ended lines/all	Leak rate (kg/hr) = $2.20E-06 \times (SV)^{0.704}$

^aThe correlations presented in this table are revised petroleum industry correlations.

^bSV = Screening value in ppmv.

^cThese correlations predict total organic compound emission rates (including non-VOC's such as methane and ethane).

^dThe "other" equipment type was derived from instruments, loading arms, pressure relief valves, stuffing boxes, and vents. This "other" equipment type should be applied to any equipment type other than connectors, flanges, open-ended lines, pumps, or valves.

SOCMI Correlation Curves

Screening Values 0-1,000 ppmv

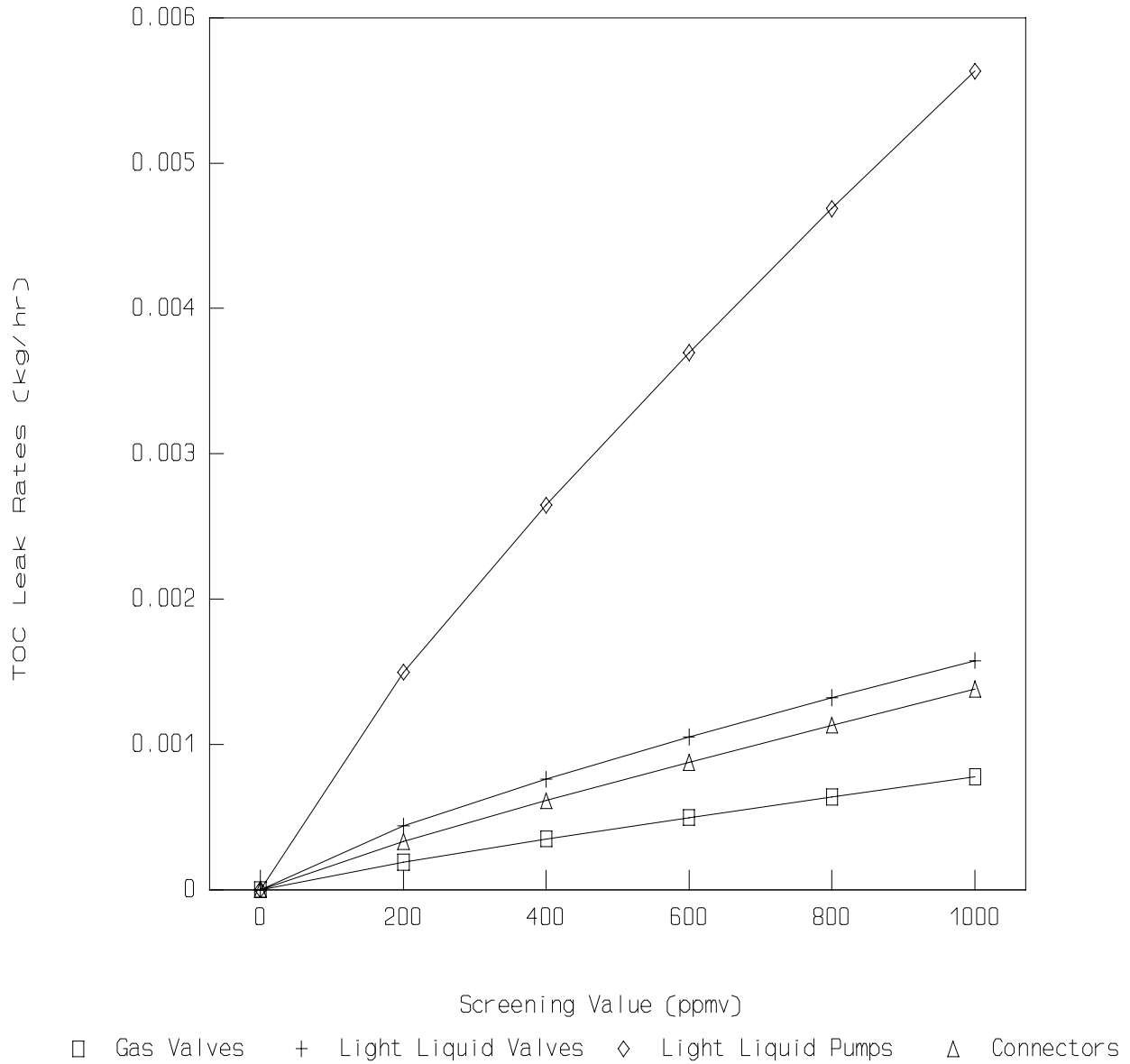

Figure 2-2. SOCMI Correlations relating total organic compound (TOC) leak rate to screening value:
0 - 1,000 ppmv

SOCMI Correlation Curves

Screening Values 1,000-1,000,000 ppmv

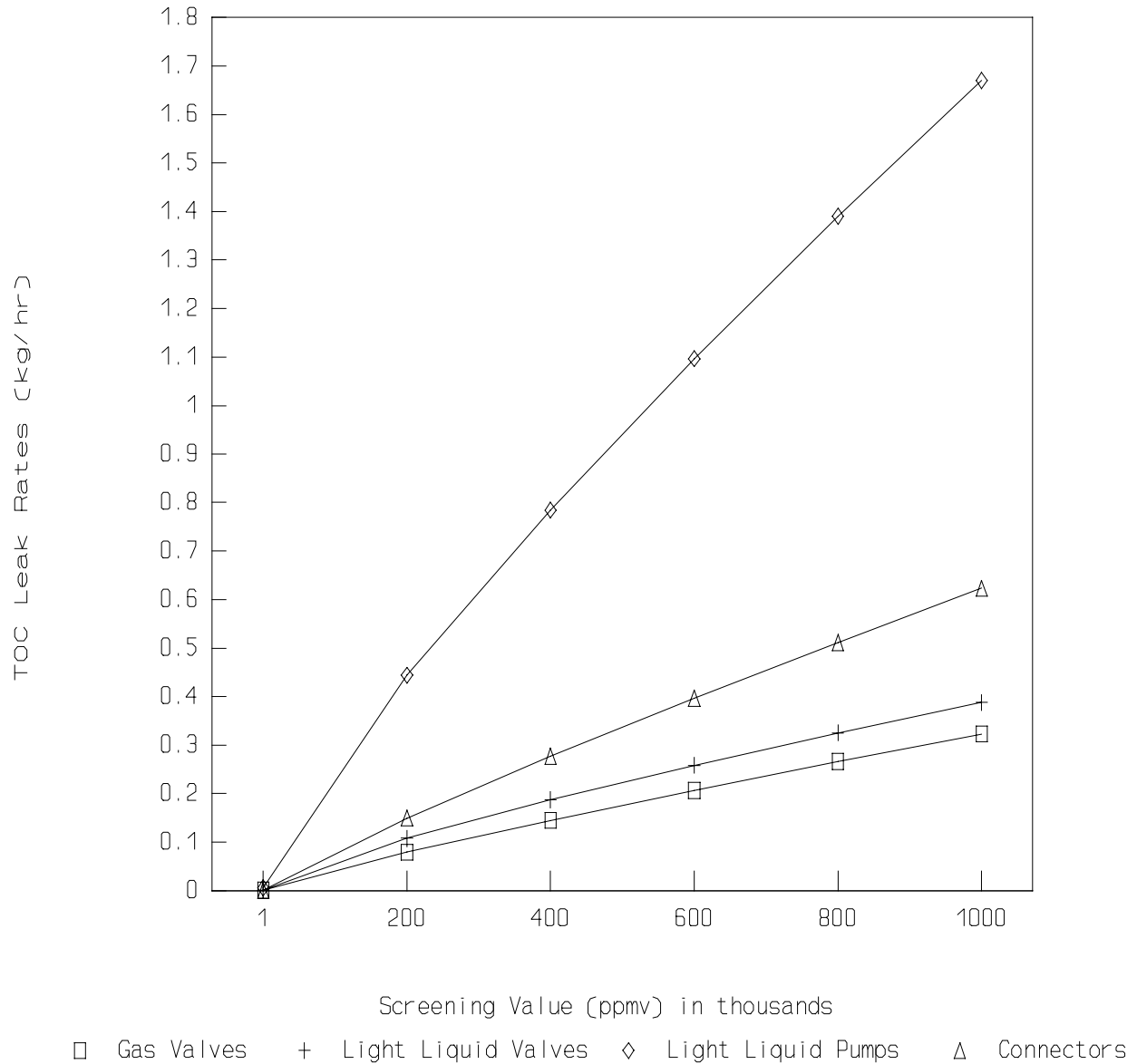

Figure 2-3. SOCMI Correlations relating total organic compound (TOC) leak rate to screening value:
1,000 - 1,000,000 ppmv

Petroleum Industry Correlation Curves Screening Values 0 – 1,000 ppmv

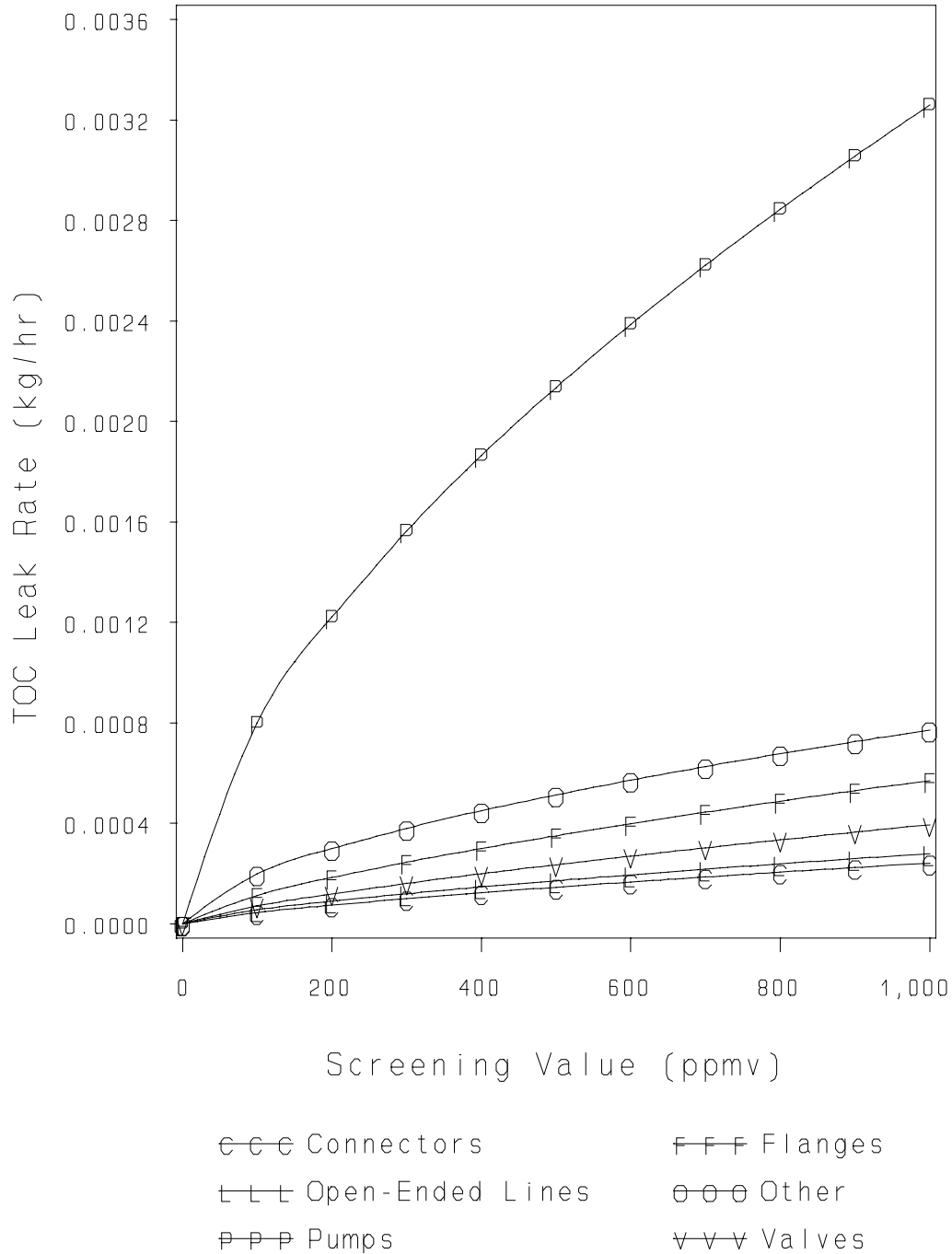

Figure 2-4. Petroleum Industry Correlations relating total organic compound (TOC) leak rate to screening value: 1,000 – 1,000,000 ppmv

Petroleum Industry Correlation Curves

Screening Values 0 – 1,000,000 ppmv

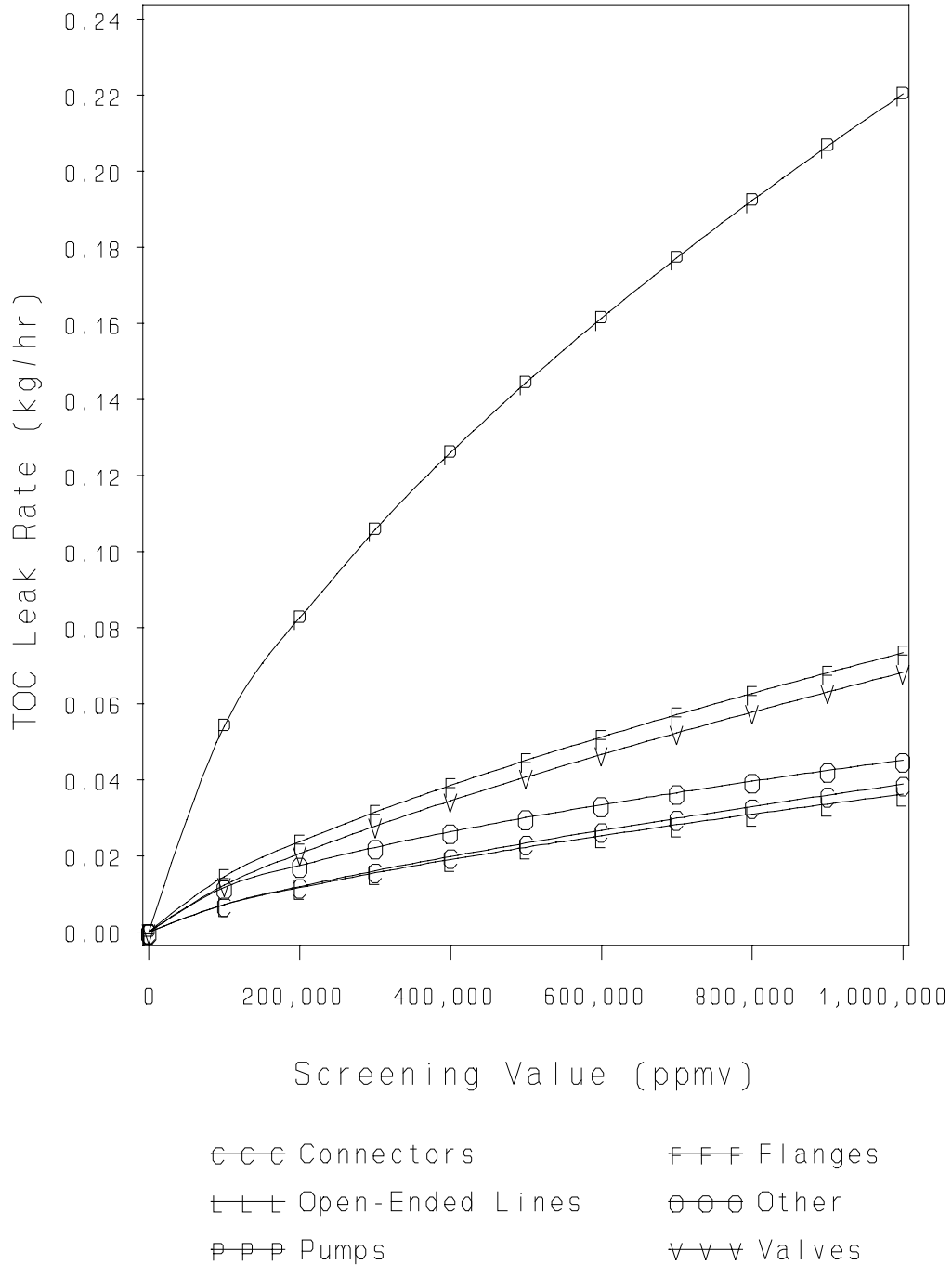

Figure 2-5. Petroleum Industry Correlations relating total organic compound (TOC) leak rate to screening value: 1,000 - 1,000,000 ppmv

estimate emissions for compressor seals and pressure relief valves in SOCFI process units. Because bagging data were limited and the frequency of occurrence of some equipment types was small, a correlation for an "other" equipment type was developed for the petroleum industry correlations to apply to any equipment type other than connectors, flanges, open-ended lines, pumps, or valves.

Bagging data for agitator seals at petroleum industry and SOCFI process units are unavailable at this time. Compared to those equipment types that have correlations, agitators most closely resemble light liquid pumps, and, for this reason, the applicable light liquid pump correlation can be used to estimate agitator emissions. Similarly, the SOCFI light liquid pump correlation can be used to estimate emissions from SOCFI heavy liquid pumps.

The "default-zero" leak rate is the mass emission rate associated with a screening value of zero. (Note that any screening value that is less than or equal to ambient [background] concentration is considered a screening value of zero.) The correlations mathematically predict zero emissions for zero screening values. However, data collected by the EPA show this prediction to be incorrect. Mass emissions have been measured from equipment having a screening value of zero. A specific goal when revising the SOCFI and petroleum industry correlations was to collect mass emissions data from equipment that had a screening value of zero. These data were used to determine a default-zero leak rate associated with equipment with zero screening values.

Table 2-11 lists the SOCFI default-zero leak rates and table 2-12 presents the petroleum industry default-zero leak rates for each of the equipment types with correlation equations. These default-zero leak rates are applicable only when the minimum detection limit of the portable monitoring instrument is 1 ppmv or less above background.

The portable monitoring device used to collect the default-zero data was sufficiently sensitive to indicate a

TABLE 2-11. DEFAULT-ZERO VALUES: SOCFI PROCESS UNITS

Equipment type	Default-zero emission rate (kg/hr/source) ^a
Gas valve	6.6E-07
Light liquid valve	4.9E-07
Light liquid pump ^b	7.5E-06
Connectors	6.1E-07

^aThe default zero emission rates are for total organic compounds (including non-VOC's such as methane and ethane).

^bThe light liquid pump default zero value can be applied to compressors, pressure relief valves, agitators, and heavy liquid pumps.

TABLE 2-12. DEFAULT-ZERO VALUES: PETROLEUM INDUSTRY

Equipment type/service	Default-zero emission rates ^{a,b} (kg/hr/source)
Valves/all	7.8E-06
Pump seals/all	2.4E-05
Others ^c /all	4.0E-06
Connectors/all	7.5E-06
Flanges/all	3.1E-07
Open-ended lines/all	2.0E-06

^aDefault zero emission rates were based on the combined 1993 refinery and marketing terminal data only (default zero data were not collected from oil and gas production facilities).

^bThese default zero emission rates are for total organic compounds (including non-VOC's such as methane and ethane).

^cThe "other" equipment type was developed from instruments, loading arms, pressure relief valves, stuffing boxes, vents, compressors, and dump lever arms. This "other" equipment type should be applied to any equipment type other than connectors, flanges, open-ended lines, pumps, or valves.

screening value of 1 ppmv or less. In cases where a monitoring instrument has a minimum detection limit greater than 1 ppmv, the default-zero leak rates presented in tables 2-11 and 2-12 are not applicable. For these cases, an alternative approach for determining a default-zero leak rate is to (1) determine one-half the minimum screening value of the monitoring instrument, and (2) enter this screening value into the applicable correlation to determine the associated default-zero leak rate.

The "pegged" emission rate is the mass emission rate associated with a screening value that has "pegged" the meter on the portable screening device (i.e. the screening value is beyond the upper limit measured by the portable screening device). In the case of a screening value pegged at 10,000 ppmv, a dilution probe should be used to extend the upper limit of the portable screening device to 100,000 ppmv. Thus, screening values can be reported up to 100,000 ppmv before pegging the instrument and the correlation equation can be used to estimate the mass emissions. However, in the case of previously-collected data or in the absence of a dilution probe, pegged readings of 10,000 ppmv are sometimes reported. In such cases, the 10,000 ppmv pegged emission rates can be used to estimate the mass emissions.

Table 2-13 presents the 10,000 ppmv and 100,000 ppmv pegged emission rates for SOCFI process units and table 2-14 presents the 10,000 ppmv and 100,000 ppmv pegged emission rates for petroleum industry process units. These pegged emission rates are to be used to estimate emissions when instrument readings are pegged and a dilution probe is not used.

Assuming all of the organic compounds in the equipment are classified as VOC's, total VOC emissions for each equipment type are calculated as the sum of emissions associated with each of the screening values. Section 2.4.6 discusses a correction that can be made to the predicted VOC emissions rate if some of the organic compounds in the equipment are not classified as VOC's (such as methane and ethane).

To summarize the correlation approach, each equipment piece with a screening value of zero is assigned the default-zero leak

TABLE 2-13. 10,000 PPMV AND 100,000 PPMV SCREENING VALUE PEGGED EMISSION RATES FOR SOCMI PROCESS UNITS

Equipment type	10,000 ppmv pegged emission rate (kg/hr/source) ^{a,b}	100,000 ppmv pegged emission rate (kg/hr/source) ^a
Gas valves	0.024	0.11
Light liquid valves	0.036	0.15
Light liquid pump seals ^b	0.14	0.62
Connectors	0.044	0.22

^aThe SOCMI pegged emission rates are for total organic compounds.

^bThe 10,000 ppmv pegged emission rate applies only when a dilution probe cannot be used or in the case of previously-collected data that contained screening values reported pegged at 10,000 ppmv.

^cThe light liquid pump seal pegged emission rates can be applied to compressors, pressure relief valves, and agitators.

TABLE 2-14. 10,000 ppmv and 100,000 PPMV SCREENING VALUE PEGGED EMISSION RATES FOR THE PETROLEUM INDUSTRY

Equipment type/service	10,000 ppmv pegged emission rate (kg/hr/source) ^{a, b}	100,000 ppmv pegged emission rate (kg/hr/source) ^a
Valves/all	0.064	0.140
Pump seals/all	0.074	0.160 ^c
Others ^d /all	0.073	0.110
Connectors/all	0.028	0.030
Flanges/all	0.085	0.084
Open-ended lines/all	0.030	0.079

^aThe petroleum industry pegged emission rates are for total organic compounds (including non-VOC's such as methane and ethane).

^bThe 10,000 ppmv pegged emission rate applies only when a dilution probe cannot be used or in the case of previously-collected data that contained screening values reported pegged at 10,000 ppmv. The 10,000 ppmv pegged emission rate was based on components screened at greater than or equal to 10,000 ppmv; however, in some cases, most of the data could have come from components screened at greater than 100,000 ppmv, thereby resulting in similar pegged emission rates for both the 10,000 and 100,000 pegged levels (e.g., connector and flanges).

^cOnly 2 data points were available for the pump seal 100,000 pegged emission rate; therefore the ratio of the pump seal 10,000 pegged emission rate to the overall 10,000 ppmv pegged emission rate was multiplied by the overall 10,000 ppmv pegged emission rate to approximate the pump 100,000 ppmv pegged emission rate.

^dThe "other" equipment type was developed from instruments, loading arms, pressure relief valves, stuffing boxes, vents, compressors, dump lever arms, diaphragms, drains, hatches, meters, and polished rods. This "other" equipment type should be applied to any equipment type other than connectors, flanges, open-ended lines, pumps, and valves.

rate. For all equipment with a non-zero screening value, the screening value associated with each individual equipment piece is entered into the applicable correlation to predict emissions. *It should be noted that each individual screening value must be entered into the correlation to predict emissions for an equipment piece. Do not average screening values and then enter the average value into the correlation to estimate emissions.* Finally, each equipment piece with a screening value reported as pegged is assigned the appropriate pegged emission rate.

2.3.4 Unit-Specific Correlation Approach

To develop unit-specific correlations screening value and corresponding mass emissions data (i.e., bagging data) must be collected from process unit equipment. (See chapter 4.0 for a detailed discussion on the procedures for bagging equipment.) The equipment selected for bagging should be screened at the time of bagging. The mass emissions rate determined by bagging, and the associated screening value, can then be used to develop a leak rate/screening value relationship (i.e., correlation) for that specific equipment type in that process unit. The correlations must be developed on a process unit basis to minimize the error associated with differing leak rate characteristics between units.

If a unit-specific correlation is developed, as long as the procedures for bagging discussed in chapter 4.0 are followed, it is not necessary to demonstrate that the correlation is statistically different from the EPA correlation for it to be applied. However, before developing unit-specific correlations, it may be desirable to evaluate the validity of the EPA correlations to a particular process unit. As few as four leak rate measurements of a particular equipment type in a particular service can be adequate for this purpose. The measured emission rates can be compared with the rates that would be predicted by the EPA correlations to evaluate whether or not the EPA correlations provide reasonable mass emission estimates. A simple method of comparison is to determine if measured emission rates are consistently less than or greater than what would be

predicted by the EPA correlation. If there is a consistent trend, such as all of the measured leak rates being lower than the rate predicted by the EPA correlation, the EPA correlation may not provide reasonable emission estimates for the process unit.

A more formal comparison is the Wilcoxon signed-rank test. This test can be performed by comparing the logarithm of the measured mass emission rates to the logarithm of the corresponding rates predicted by the EPA correlation. The absolute magnitude of the differences are then ranked (e.g., the pair with the smallest difference is assigned a rank of 1, the pair with the next smallest difference a rank of 2, etc.), and the sum of the ranks associated with positive differences is computed. For example, if four bags were measured and they each predicted higher mass emission rates than the EPA correlation, the value of the sum of the ranks associated with those pairs with positive differences would equal:

$$1 + 2 + 3 + 4 = 10$$

On the other hand, if four bags were measured and three predicted higher mass emission rates than the EPA correlation, but the one with the greatest absolute difference predicted a lower rate than the EPA correlation, then the sum of the positive ranks would equal:

$$1 + 2 + 3 = 6. \quad (\text{Note: } \textit{The sum of the negative ranks would equal 4}).$$

The value of the sum of the positive ranks can be compared to given values on statistical tables to evaluate if there are statistically significant differences between the measured rates and the rates predicted by the EPA correlation.

However the comparison is performed, in cases where the EPA correlations provide an adequate estimate of emissions, then the potential increase in accuracy obtained by developing

unit-specific correlations may not be worth the effort. Consideration should also be given to the typical screening value measured at a process unit. If a process unit normally has very low screening values, then the difference between the sum of unit equipment leak emissions predicted by a unit-specific correlation and the EPA correlation will likely be relatively small.

In developing new correlations, a minimum number of leak rate measurements and screening value pairs must be obtained according to the following methodology. First, equipment at the process unit is screened so that the distribution of screening values at the unit is known. Then, mass emissions data must be collected from individual sources that have screening values distributed over the entire range. The criteria for choosing these sources is as follows. For each equipment type (i.e., valves, pumps, etc.) and service (i.e., gas, light liquid, etc.), a random sample of a minimum of six components should be chosen for bagging from each of the following screening value ranges:

Screening Value Range (ppmv)

- 1 - 100
- 101 - 1,000
- 1,001 - 10,000
- 10,001 - 100,000
- > 100,000

The requirement of six bags per screening value range is based on the EPA experience with bagging components. There are two primary reasons for the above requirement: (1) to be confident in the representativeness of the data, and (2) to accurately reflect the range of possible mass emission rates associated with a given screening value. The importance of the first reason is self-evident: The more data collected the better the representativeness. The importance of the second reason is that a given screening value does not necessarily have a "true" emissions rate. For a single screening value, the mass emissions may range over several orders of magnitude depending upon several

factors, including the equipment type (i.e., gate valve versus ball valve versus plug valve, etc.) and operating parameters (i.e., chemical handled, temperature, pressure, etc.). This range of possible mass emission rates is accounted for when the correlation is developed (see discussion on the scale bias correction factor), and it is important to obtain enough data to accurately reflect the range. If six sources are not available in a particular screening value range, additional sources from the nearest range should be tested so that a minimum of 30 emission rate/screening value pairs are obtained for each source type. If 30 or more bags are collected, the process unit-specific correlation can be used to estimate emissions across the entire range of screening values (1 to 1,000,000 ppmv).

In some cases, it may be desirable to develop a correlation with fewer than 30 bags. This can be accomplished by developing a correlation that is not valid across the entire range of screening values. Two alternatives are available: (1) to develop a correlation valid for screening values ranging from 1 to 100,000 ppmv, or (2) to develop a correlation valid for screening values ranging from 1 to 10,000 ppmv. These alternatives may be preferable for process units with equipment that do not normally have high screening values. An example of this type of process unit is one that already has a leak detection and repair program in place to prevent the release of odor-causing chemicals. At this type of process unit, leaks may be quickly detected and repaired.

For the first alternative, a minimum of 24 bags are required, rather than 30, because sources with screening values greater than 100,000 ppmv do not need to be bagged. Thus, a minimum of six sources each should be chosen for bagging from each of the screening ranges presented above except for the greater than 100,000 ppmv range. In the event that a source screens at 100,000 ppmv or greater, emissions can be estimated using "pegged" emission rates shown in table 2-13 for SOCFI process units, and in table 2-14 for petroleum industry process units.

For the second alternative, a minimum of 18 bags are required, because sources screening greater than 10,000 ppmv do not need to be bagged. Thus, a minimum of six sources should be chosen for bagging from the 1 to 100 ppmv range, the 100 to 1000 ppmv range, and the 1,000 to 10,000 ppmv range. In the event that a source screens at 10,000 ppmv or greater, emissions can be estimated using the applicable greater than or equal to 10,000 ppmv pegged emission rate presented in table 2-13 for SOCOMI process units, or table 2-14 for petroleum industry process units. An advantage of using the greater than or equal to 10,000 ppmv pegged emission rates is that several of the available portable monitoring instruments have a maximum readout of 10,000 ppmv, and to obtain a screening value from a source screening at 10,000 ppmv, it is necessary to install a dilution probe. However, if the greater than or equal to 10,000 ppmv factor is used, installing a dilution probe is not necessary for this alternative.

The above groupings and recommended number of sources are given as guidelines. They are based on experience in measuring leak rates and developing leak rate/screening value correlations. Other source selection strategies can be used if an appropriate rationale is given.

With mass emissions data and screening values, leak rate/screening value correlations can be generated using the following methodology. Least-squares regression analyses are completed for each equipment type/service, regressing the log of the leak rate on the log of the screening concentration, according to:

$$\text{Log}_{10} (\text{leak rate [in kg/hr]}) = \beta_0 + \beta_1 \times \text{Log}_{10} (\text{SV})$$

where:

β_0, β_1 = Regression constants; and

SV = Screening value.

Note that the results are the same whether the base 10 or natural logarithm are used (see appendix B). The equations presented here are written assuming the base 10 logarithm is used. All analyses should be conducted using logarithms of both the leak rate and screening value because this type of data has been shown to be log-normally distributed. A scale bias correction factor (SBCF) is required in transforming the equation in the log-scale back to the original units. The transformed equation is the unit-specific correlation, and is expressed as:

$$\text{Leak rate} = \text{SBCF} \times 10^{\beta_0} \times \text{SV}^{\beta_1}$$

where:

- Leak rate = Emission rate of TOC's from the individual equipment piece (kg/hr);
- SBCF = Scale bias correction factor;
- β_0, β_1 = Regression constants; and
- SV = Screening value.

The SBCF is a function of the mean square error of the correlation in log space. The greater the range of possible emission rates for a given screening value, the greater the SBCF will be. The purpose of the SBCF is to reflect this range when transforming the correlation out of log space. When regressed in log space, in general, approximately half of the data points will lie above the correlation line and half will lie below it, and, for a given screening value, the correlation will pass through the mean log leak rate (i.e., the geometric mean). Thus, one way of thinking of the correlation in log space is that it predicts the geometric mean emissions rate across the range of screening values. However, the geometric mean always underestimates the arithmetic mean.

A simplified hypothetical example will help demonstrate this point: For a screening value of 500,000 ppmv, three bagging data points were obtained with mass emission rates of 0.1 kg/hr,

1 kg/hr, and 10 kg/hr. In log space, these emission rates correspond to $\log_{10} (0.1) = -1$, $\log_{10} (1) = 0$, and $\log_{10} (10) = 1$, respectively. Thus, the geometric mean of these three points is $(-1 + 0 + 1)/3 = 0$. Directly transforming this geometric mean to normal space predicts an emission rate for a screening value of 500,000 ppmv of $10^0 = 1$ kg/hr, whereas the arithmetic mean of the emission rates is $(0.1 + 1 + 10)/3 = 3.7$ kg/hr. From this example, it can be seen that the geometric mean underestimates the arithmetic mean.

Thus, if the correlation was directly transformed, it would underestimate the true average emission rate associated with a given screening value, and, for this reason, the SBCF is necessary to transform the correlation out of log space.

In appendix B, additional details on developing a process-unit specific correlation are presented. Appendix B also contains information on development of the revised SOCFI correlations.

2.4 SPECIAL TOPICS

There are several special topics relevant to estimating equipment leak emissions that are not specific to any one of the four approaches that have been described. These special topics are discussed in this section:

- Speciating emissions;
- Using response factors;
- Monitoring instrument type and calibration gas;
- Estimating emissions for equipment not screened (when other screening data are available);
- Using screening data collected at several different times;
- Estimating VOC emission rates from equipment containing organic compounds not classified as VOC's (such as methane and ethane); and
- Estimating equipment leak emissions of inorganic compounds.

Each of these topics above are addressed in the following sections.

2.4.1 Speciating Emissions

For each of the four approaches for estimating equipment leak emissions, the equations presented are used to estimate TOC emissions for estimating equipment leak emissions. Often, in a chemical-handling facility, material in equipment is a mixture of several chemicals, and, in some cases, it may be necessary to estimate emissions of a specific VOC in the mixture. The following equation is used to speciate emissions from a single equipment piece:

$$E_x = E_{\text{TOC}} \times (WP_x/WP_{\text{TOC}})$$

where:

- E_x = The mass emissions of organic chemical "x" from the equipment (kg/hr);
- E_{TOC} = The TOC mass emissions from the equipment (kg/hr) calculated from either the Average Emission Factor, Screening Ranges, Correlation, or Unit-Specific Correlation approaches;
- WP_x = The concentration of organic chemical "x" in the equipment in weight percent; and
- WP_{TOC} = The TOC concentration in the equipment in weight percent.

An assumption in the above equation is that the weight percent of the chemicals in the mixture contained in the equipment will equal the weight percent of the chemicals in the leaking material. In general, this assumption should be accurate for single-phase streams containing (1) any gas/vapor material, or (2) liquid mixtures containing constituents of similar volatilities.

If the material in the equipment piece is a liquid mixture of constituents with varying volatilities, in certain cases this assumption may not be correct. Whether or not the assumption is valid for a liquid mixture of varying volatilities depends on the physical mechanism of how the leakage occurs from the equipment.

If the physical mechanism is one in which the liquid "flashes" before it leaks from the equipment, the leaking vapor may contain a higher concentration of the more volatile constituents than is contained in the liquid mixture. On the other hand, if the mechanism is one in which the liquid material leaks from the equipment and then evaporates, the assumption that the weight percent of each constituent in the liquid will equal the weight percent of each constituent in the vapor is valid. There are no clear guidelines to determine what mechanism is taking place for any given piece of equipment; for this reason, unless there is information to suggest otherwise, it should be assumed that the leaking vapor has the same concentrations as the liquid.

For those cases where it is suspected the leaking vapor will have different concentrations than the liquid, engineering judgement should be used to estimate emissions of individual chemical species. An example might be equipment containing material in two phases. Another hypothetical example is a case where equipment contain a liquid mixture of two constituents with one of the constituents having a very low vapor pressure and the other a much higher vapor pressure. Leaks may occur from the equipment such that the constituent with higher vapor pressure volatilizes to the atmosphere, but the constituent with lower vapor pressure is washed to the waste water treatment system prior to volatilization.

2.4.2 Using Response Factors

A correction factor that can be applied to a screening value is a response factor (RF) that relates the actual concentration to the measured concentration of a given compound, using a specific reference gas. As stated earlier, screening values are obtained by using a portable monitoring instrument to detect VOC's at an equipment piece leak interface. An "ideal" screening RF value is one that is equal to the actual concentration of VOC's at the leak interface. However, portable monitoring instruments used to detect TOC concentration do not respond to different TOC's equally. (This is discussed in more detail in chapter 3.0). To demonstrate this point, consider a monitoring

instrument calibrated using a reference gas. If the instrument is calibrated correctly and is used to measure the concentration of the gas with which it has been calibrated, it will indicate the actual concentration. However, when used to measure other gases for which the monitoring instrument is more or less sensitive than the calibration gas, it will not indicate the actual concentration. To correct for this, RF's have been developed. The RF is calculated using the equation:

$$RF = AC/SV$$

where:

RF = Response factor;

AC = Actual concentration of the organic compound (ppmv);
and

SV = Screening value (ppmv).

The value of the RF is a function of several parameters. These parameters include the monitoring instrument, the calibration gas used to calibrate the instrument, the compound(s) being screened, and the screening value.

The correlations presented in this chapter have been developed primarily from screening value/mass emission data pairs collected from equipment containing compounds that had RF's less than three. Thus, for cases in which a calibrated instrument is used to measure concentrations of a compound for which that instrument has an RF of three or less, reasonably accurate emission estimates can be obtained directly without adjusting the screening value. However, for a case in which a compound has an RF greater than three for the calibrated instrument, the emissions estimated using the unadjusted screening value will generally underestimate the actual emissions. The EPA recommends that if a compound (or mixture) has an RF greater than three, then the RF should be used to adjust the screening value before it is used in estimating emissions.

A detailed listing of published RF's is contained in appendix D. These RF's were developed by injecting a known concentration of a pure compound into a monitoring instrument and comparing that actual concentration to the instrument readout (i.e., screening value).

As an example of applying a RF, consider chloroform. From table D-2 in appendix D, it can be seen that the RF for chloroform at an actual concentration of 10,000 ppmv is equal to 4.48 for a Foxboro OVA-108 monitoring instrument calibrated with methane. Thus, when the actual concentration of chloroform is 10,000 ppmv, the instrument will read 10,000 ppmv divided by 4.48, which equals 2,230 ppmv. If the measured value for chloroform was directly entered into the correlation, it would tend to underestimate emissions. (Note that when the RF is less than 1 the unadjusted screening value will tend to overestimate actual emissions.)

The RF's in appendix D are for pure compounds. Those RF's can be used to estimate the RF for a mixture using the equation:

$$RF_m = \frac{1}{\sum_{i=1}^n (x_i / RF_i)}$$

where:

- RF_m = Response factor of the mixture;
- n = Number of components in the mixture;
- x_i = Mole fraction of constituent i in the mixture; and
- RF_i = Response factor of constituent i in the mixture.

This equation is derived in appendix A.

An alternative approach for determining the RF of a pure compound or a mixture is to perform analysis in a laboratory to generate the data used to calculate a RF. The approach for generating these data in the laboratory is described in chapter 3.0. The approach involves injecting samples of a known concentration of the material of interest into the actual portable monitoring instrument used to obtain the screening values and calculating the RF based on the instrument readout.

In general, calculating the RF by performing analysis on site will give the most accurate RF information, since, among other factors, RF's have been shown to be a function of the individual monitoring instrument.

Ideally, when using screening values to estimate equipment leak emissions, the RF would be equal to 1, and, in this way, the screening value would be the actual concentration. However, because RF's are a function of several parameters, this cannot normally be achieved. Response factors can be used to correct all screening values, if so desired. To evaluate whether a RF correction to a screening value should be made, the following three steps can be carried out.

- (1) For the combination of monitoring instrument and calibration gas used, determine the RF's of a given material at an actual concentration of 500 ppmv and 10,000 ppmv. (See appendix D; in some cases, it may not be possible to achieve an actual concentration of 10,000 ppmv for a given material. In these cases, the RF at the highest concentration that can be safely achieved should be determined.)
- (2) If the RF's at both actual concentrations are below 3, it is not necessary to adjust the screening values.
- (3) If either of the RF's are greater than 3, then the EPA recommends an RF be applied for those screening values for which the RF exceeds 3.

One of the following two approaches can be applied to correct screening values:

- (1) Use the higher of either the 500 ppmv RF or the 10,000 ppmv RF to adjust all screening values.
- (2) Generate a response factor curve to adjust the screening values.

A RF curve can be generated in one of two ways. The simplest way is to assume that the RF value is a linear function of the screening value. The first step to generate a line relating screening value to RF is to convert the RF at the actual concentration to the RF at the associated screening value. This is done by dividing the RF by the actual concentration to get the associated screening value. Thus, if, at an actual concentration

of 10,000 ppmv, an instrument has a RF of 5, this corresponds to a screening value of 2,000 ppmv (i.e., 10,000 ppmv divided by 5). This procedure is implemented at both actual concentrations of 10,000 ppmv and 500 ppmv, and a line is drawn between the RF's at each associated screening value. This line can then be used to estimate the RF at any given screening value. (See appendix A for a demonstration of this procedure.) The line should not be extrapolated for screening values beyond the endpoints. For these screening values, the endpoint RF should be applied.

For some materials, the RF is nonlinear as the screening value increases. For these materials, RF's at several screening values can be estimated by collecting data in a laboratory, as mentioned earlier. The RF/screening value relationship can then be generated by fitting a curve through the data pairs.

When an RF is used, the screening value is multiplied by the RF before mass emissions are estimated. Thus, if a screening value is 3,000 ppmv and the associated RF is 4, then the screening value must be adjusted to 12,000 ppmv (i.e., 3,000 multiplied by 4) before mass emissions are predicted.

It should be noted that if it is possible to calibrate the monitoring instrument with the material contained in the equipment that is being screened, the RF should equal 1. Thus, theoretically, the screening values will equal the actual concentration, and no RF adjustment will be necessary. If it is necessary to apply RF's, site personnel should use engineering judgement to group process equipment into streams containing similar compounds. All components associated with a given stream can then be assigned the same RF, as opposed to calculating an RF for each individual equipment piece.

2.4.3 Monitoring Instrument Type and Calibration Gas

When the correlations presented in section 2.3 were developed, in general, for each of the source categories, the data were collected using a specific type of monitoring instrument calibrated with a specific calibration gas. The correlations are intended to relate actual concentration to mass emissions. For this reason, screening values obtained from any

combination of monitoring instrument and calibration gas can be entered directly into the correlations as long as the screening values are an indication of actual concentration. If the screening values are not an indication of the actual concentration, the guidelines set forth in the previous section on RF's can be applied to correct the screening values (i.e., screening values should be adjusted if the RF is greater than 3). Otherwise, it is not necessary to correct screening values to account for the instrument type and calibration gas that were used to develop the correlation curves developed by the EPA.

2.4.4 Estimating Emissions for Equipment Not Screened

Often, screening data cannot be collected for all of the equipment pieces in a process unit. In some cases, equipment are difficult or unsafe to screen. Difficult or unsafe to screen equipment must be included in the equipment counts. For these equipment pieces, the average emission factors must be used to estimate emissions.

In other cases, it is not possible to screen every equipment piece due to cost considerations. This is particularly true for connectors. Appendix E provides criteria for determining how many connectors must be screened to constitute a large enough sample size to identify the screening value distribution for connectors. If the criteria in appendix E are met, the average emission rate for connectors that were screened can be applied to connectors that were not screened. It should be noted that if connectors must be included in a leak detection and repair program as part of an equipment leaks standard, then all connectors must be screened. For equipment types other than connectors, if they are not monitored, the Average Emission Factor approach should be used to estimate emissions.

2.4.5 Using Screening Data Collected at Several Different Times

When screening data is collected and used to estimate emissions, the emissions estimate represents a "snapshot" of emissions at the time the screening data were obtained. Over

time, it is possible that more screening data will be collected, and that for individual equipment pieces, several screening values will have been obtained at different time periods. For example, if quarterly monitoring is performed on a valve, in an annual period four screening values will be obtained from the valve. The annual emissions from the valve should be calculated by determining the emissions for each quarter based on the operational hours for the quarter, and summing the quarterly emissions together to arrive at emissions for the entire year. See appendix A for an example of estimating emissions from an equipment piece for which more than one screening value has been obtained.

2.4.6 Estimating VOC Emission Rates from Equipment Containing Non-VOC's

Some organic compounds not classified as VOC's can be detected by the screening instrument. Because the compounds are detected, the emissions associated with the screening value will include emissions of the "non-VOC's." The two key organic compounds not classified as VOC's are methane and ethane, but other organic compounds not classified as VOC's include methylene chloride, 1,1,1-trichloroethane, and several chlorofluorocarbons. An approach very similar to that outlined in section 2.4.1 (Speciating Emissions) is used to estimate VOC emissions from equipment containing these non-VOC's mixed with VOC's.

Once TOC emissions have been estimated by using either the Average Emission Factor, the Screening Ranges, the Correlation, or the Unit-Specific Correlation approaches, the VOC emissions from a group of equipment containing similar composition can be calculated using the equation:

$$E_{VOC} = E_{TOC} \times (WP_{VOC}/WP_{TOC})$$

where:

E_{VOC} = The VOC mass emissions from the equipment (kg/hr);

E_{TOC} = The TOC mass emissions from the equipment (kg/hr) calculated from either the Average

Emission Factor, Screening Ranges, Correlation, or Unit-Specific Correlation approaches;

WP_{VOC} = The concentration of VOC in the equipment in weight percent;

WP_{TOC} = The TOC concentration in the equipment in weight percent.

2.4.7 Estimating Equipment Leak Emissions of Inorganic Compounds

The majority of data collected for estimating equipment leak emissions has been for TOC's or VOC's and not for inorganic compounds. Accordingly, the emission factors and correlations presented in section 2.3 are not intended to be applied for the used of estimating emissions of inorganic compounds. However, in some cases, there may be a need to estimate equipment leak emissions of inorganic compounds--particularly for those that exist as a gas/vapor or for those that are volatile. Some examples of inorganic compounds include sulfur dioxide, ammonia, and hydrochloric acid.

The best way to estimate equipment leak emissions of inorganic compounds would be to develop unit-specific correlations as described in section 2.3.4. To do this, it would be necessary to obtain a portable monitoring instrument that could detect the inorganic compounds. If it is not possible to develop a unit-specific correlation, but a portable monitoring instrument (or some other approach) can be used to indicate the actual concentration of the inorganic compound at the equipment leak interface, then the "screening values" obtained with this instrument can be entered into the applicable correlations presented in section 2.3.3 to estimate emissions. Alternatively, the equal to or greater than 10,000 ppmv, or the less than 10,000 ppmv emission factors could be applied. In the event that there is no approach that can be used to estimate the concentration of the inorganic compound at the leak interface, then in the absence of any other data, the average emission factors can be used.

2.5 REFERENCES

1. Radian Corporation. Assessment of Atmospheric Emissions from Petroleum Refining: Volume 4. Appendices C, D, E. Prepared for U.S. Environmental Protection Agency. Research Triangle Park, NC. Publication No. EPA-600/2-80-075d. July 1980.
2. Wetherhold, R.G., L.P. Provost, and C.D. Smith (Radian Corporation). Assessment of Atmospheric Emissions from Petroleum Refining: Volume 3. Appendix B. Prepared for U.S. Environmental Protection Agency. Research Triangle Park, NC. Publication No. EPA-600/2-80-075c. April 1980.
3. DuBose, D.A., J.I. Steinmetz, and G.E. Harris (Radian Corporation). Frequency of Leak Occurrence and Emission Factors for Natural Gas Liquid Plants. Final Report. Prepared for U.S. Environmental Protection Agency. Research Triangle Park, NC. EMB Report No. 80-FOL-1. July 1982.
4. 1993 Study of Refinery Fugitive Emissions from Equipment Leaks, Volumes I, II, and III, Radian DCN No. 93-209-081-02, Radian Corporation, Prepared for Western States Petroleum Association, Glendale, CA, and American Petroleum Institute, Washington, D.C., 1994.
5. Development of Fugitive Emission Factors and Emission Profiles for Petroleum Marketing Terminals, Volumes I and II, API 4588, Radian Corporation, Prepared for American Petroleum Institute, 1993.
6. Fugitive Hydrocarbon Emissions from Oil and Gas Production Operations, API 4589, Star Environmental, Prepared for American Petroleum Institute, 1993.
7. Emission Factors for Oil and Gas Production Operations, API 4615, Star Environmental, Prepared for American Petroleum Institute, 1995.
8. Letter from Robert Strieter, API, to David Markwordt, U.S. EPA, regarding the submittal of gasoline distribution facility fugitive equipment screening data. April 26, 1994.
9. Blacksmith, J.R., et al. (Radian Corporation.) Problem-Oriented Report: Frequency of Leak Occurrence for Fittings in Synthetic Organic Chemical Plant Process Units. Prepared for U.S. Environmental Protection Agency. Research Triangle Park, NC. Publication No. EPA-600/2-81-003. September 1980.
10. Langley, G.J. and R.G. Wetherhold. (Radian Corporation.) Evaluation of Maintenance for Fugitive VOC Emissions Control.

Prepared for U.S. Environmental Protection Agency. Research Triangle Park, NC. Publication No. EPA-600/S2-81-080. May 1981.

11. U.S. Environmental Protection Agency. Fugitive Emission Sources of Organic Compounds - Additional Information of Emissions, Emission Reductions, and Costs (section 2). Research Triangle Park, NC. Publication No. EPA-450/3 82-010. April 1982.

3.0 SOURCE SCREENING

3.1 INTRODUCTION

This chapter presents procedures for screening equipment components with a portable volatile organic compound (VOC) analyzer. When performing source screening, the portable analyzer probe opening is placed at the leak interface of the equipment component to obtain a "screening" value. The screening value is an indication of the concentration level of any leaking material at the leak interface. A screening value is not a direct measure of mass emissions rate, but, as discussed in chapter 2.0, can be entered into a mass emissions/screening value correlation equation to estimate mass emissions.

This chapter is divided into two sections. The first section provides a description of the portable analyzers that can be used when conducting screening surveys. Operating principles of the analyzers and performance criteria and specifications in the EPA Reference Method 21 (the method describing the use of portable VOC analyzers)¹ are described, and the use of monitoring devices that do not meet the EPA Reference Method 21 requirements is discussed. The second section presents the protocol for successfully conducting a screening program. This section includes methods to identify components to be included in the screening program, a discussion on the development of a systematic approach for performing the screening survey, the protocol for screening each of the equipment types, and recommendations for collecting and handling data.

3.2 MONITORING INSTRUMENTS

A number of portable VOC detection devices have the potential to measure the concentration level at the leak interface of equipment. Any analyzer can be used, provided it meets the specifications and performance criteria set forth in the EPA Reference Method 21, section 3.0.¹. Reference Method 21 is included in this document as appendix F.

In general, portable VOC monitoring instruments are equipped with a probe that is placed at the leak interface of a piece of equipment. A pump within the instrument draws a continuous sample of gas from the leak interface area to the instrument detector. The instrument response is a screening value--that is, a relative measure of concentration level. The screening value is in units of parts per million by volume (ppmv). However, the screening value does not necessarily indicate the actual total concentration at the leak interface of the compound(s) being detected because the sensitivity of instruments vary for different compounds. As discussed in section 2.4.2, response factors (RF's) relate actual concentration of a compound to the observed concentration from the detector. Before a monitoring instrument is used, it must first be calibrated using a reference gas containing a known compound at a known concentration. Methane and isobutylene are frequently used reference compounds.

3.2.1 Operating Principles and Limitations of Portable VOC Detection Devices

Monitoring instruments operate on a variety of detection principles, with the three most common being ionization, infrared absorption, and combustion. Ionization detectors operate by ionizing the sample and then measuring the charge (i.e., number of ions) produced. Two methods of ionization currently used are flame ionization and photoionization. Each of these detector types are briefly described below.

A standard flame ionization detector (FID) theoretically measures the total carbon content of the organic vapor sampled, but many other factors influence the FID readout. Although carbon monoxide and carbon dioxide (CO₂) do not produce

interferences, FID's react to water vapor at a low sensitivity. Furthermore, erratic readings may result if water condenses in the sample tube. A filter is used to remove particulate matter from the sample. Certain portable FID instruments are equipped with gas chromatograph (GC) options making them capable of measuring total gaseous non-methane organics or individual organic components. Certain organic compounds containing nitrogen, oxygen, or halogen atoms give a reduced response when sampled with an FID, and the FID may not respond to some organic compounds.

Photoionization detectors use ultraviolet light (instead of a flame) to ionize organic vapors. As with FID's, the detector response varies with the functional group in the organic compounds. Photoionization detectors have been used to detect equipment leaks in process units in the SOCOMI, especially for certain compounds, such as formaldehyde, aldehydes, and other oxygenated compounds, which will not give a satisfactory response on a FID or combustion-type detector.

Nondispersive infrared (NDIR) instruments operate on the principle of light absorption characteristics of certain gases. These instruments are usually subject to interference because other gases, such as water vapor and CO₂, may also absorb light at the same wavelength as the compound of interest. These detectors are generally used only for the detection and measurement of single components. For this type of detection, the wavelength at which a certain compound absorbs infrared radiation is predetermined and the device is preset for that specific wavelength through the use of optical filters. For example, if set to a wavelength of 3.4 micrometers, infrared devices can detect and measure petroleum fractions, including gasoline and naphtha.

Combustion analyzers are designed either to measure the thermal conductivity of a gas or to measure the heat produced by combustion of the gas. The most common method in which portable VOC detection devices are used involves the measurement of the heat of combustion. These detection devices are referred to as

hot wire detectors or catalytic oxidizers. Combustion analyzers, like most other detectors, are nonspecific for gas mixtures. In addition, combustion analyzers exhibit reduced response (and, in some cases, no response) to gases that are not readily combusted, such as formaldehyde and carbon tetrachloride.

3.2.2 Specifications and Performance Criteria of Portable VOC Detection Devices

As previously stated, any portable analyzer may be used as a screening device, provided it meets the specifications and the performance criteria called for in the EPA Reference Method 21. (See appendix F.) Reference Method 21 specifies the requirements that must be met when a facility is collecting screening data to comply with a regulation. The requirements of the EPA Reference Method 21 are also applicable when screening data are collected for the sole purpose of estimating emissions. When the requirements of Reference Method 21 refer to a "leak definition," this is the screening value indicating that a piece of equipment is leaking as defined in the applicable regulation. If screening data are collected for the sole purpose of estimating emissions, the equivalent to the "leak definition" concentration in the text that follows is the highest screening value (i.e., 10,000 ppmv) that the monitoring instrument can readout.

Reference Method 21 requires that the analyzer meet the following specifications:¹

- The VOC detector should respond to those organic compounds being processed (determined by the RF);
- Both the linear response range and the measurable range of the instrument for the VOC to be measured and the calibration gas must encompass the leak definition concentration specified in the regulation;
- The scale of the analyzer meter must be readable to ± 2.5 percent of the specified leak definition concentration;
- The analyzer must be equipped with an electrically driven pump so that a continuous sample is provided at a nominal flow rate of between 0.1 and 3.0 liters per minute;

- The analyzer must be intrinsically safe for operation in explosive atmospheres; and
- The analyzer must be equipped with a probe or probe extension for sampling not to exceed .25 inch in outside diameter, with a single end opening for admission of sample.

Note that the suction flow rate span allowed by Reference Method 21 is intended to accommodate a wide variety of instruments, and manufacturers guidelines for appropriate suction flow rate should be followed.

In addition to the above specifications, criteria for the calibration gases to be used are specified. A minimum of two calibration gases are required for analyzer performance evaluation. One is a "zero" gas, which is defined as air with less than 10 ppmv VOC; the other calibration gas, or reference gas, uses a specified reference compound in an air mixture. The concentration of the reference compound must approximately equal the leak definition specified in the regulation. If cylinder calibration gas mixtures are used, they must be analyzed and certified by the manufacturer to be within ± 2 percent accuracy. The shelf life must also be specified. Calibration gases can also be prepared by the user as long as they are accurate to within ± 2 percent.

The instrument performance criteria that each analyzer must meet are presented in table 3-1 and discussed in greater detail in the following sections.

3.2.2.1 Response Factor. The sensitivity of an analyzer varies, depending on the composition of the sample and concentration of VOC detected. The RF quantifies the sensitivity of the analyzer to each compound. The RF is defined by:

$$RF = \frac{\text{Actual Concentration of Compound}}{\text{Observed Concentration from Detector}}$$

An RF must be determined for each compound that is to be measured. Response factors may be determined either by testing or from referenced sources. (The RF's for many commonly screened compounds are presented in appendix D.) The RF tests are

TABLE 3-1. PERFORMANCE CRITERIA FOR PORTABLE VOC DETECTORS^a

Criteria	Requirement	Time interval
Instrument response factor	Must be <10 unless correction curve is used	One time, before detector is put in service.
Instrument response time	Must be ≤30 seconds	One time, before detector is put in service. If modification to sample pumping or flow configuration is made, a new test is required.
Calibration precision	Must be ≤10 percent of calibration gas value	Before detector is put in service and at 3-month intervals or next use, whichever is later.

^aSource: Reference 1.

required before placing the analyzer into service, but do not need to be repeated. The RF for each compound to be measured must be less than 10 for an analyzer to be acceptable for use in a screening program. According to Reference Method 21, the RF can either be measured in the laboratory using a prepared gas concentration at 80 percent of the applicable leak definition, or it can be taken from values published in the literature. When no instrument is available that meets this criteria when calibrated with the reference compound specified in the applicable regulation, the available instrument may be calibrated with one of the VOC's to be measured. However, the analyzer RF must still be less than 10 for each VOC to be measured.

As discussed in section 2.4.2, RF's depend on several parameters, including the compound, the screening value, the monitoring instrument, and the calibration gas. In chapter 2.0, guidance was provided on when and how to apply RF's for estimating emissions. Methods were presented on calculating an RF for a given chemical at a screening value other than one for which data were published. Methods were also presented for calculating RF's for mixtures.

In this chapter, several additional issues pertaining to RF's are discussed. These issues are (1) the consideration of RF's when selecting a monitoring instrument, (2) how laboratory analysis can be performed to generate data to determine an RF for a given compound, and (3) when laboratory analysis is recommended.

Response factors contained in appendix D can be used as a guide for selecting an appropriate monitoring device. If at the applicable leak definition, the RF of an instrument is greater than 10, that instrument does not meet Reference Method 21 requirements unless a substitute reference gas is used to calibrate the instrument. For example, at a concentration of 10,000 ppmv, it can be seen that when screening equipment in a process unit that contains cumene, an FID can be used (RF = 1.92 at an actual concentration of 10,000 ppmv), while the catalytic oxidation detector cannot (RF = 12.49). Similarly, at a

concentration of 10,000 ppmv, neither of these devices respond to carbon tetrachloride and, therefore, cannot be used unless calibrated with a substitute VOC such that an RF of under 10 can be calculated for this compound.

Response factors can be determined by laboratory analysis using the following method. First, the analyzer is calibrated using the reference gas. Then, for each organic species that is to be measured, a known standard in air is obtained or prepared. The concentration of the organic species should be at approximately the leak definition value. This mixture is then injected into the analyzer and the observed meter reading is recorded. The analyzer is then "zeroed" by injecting zero air until a stable reading is obtained. The procedure is repeated by alternating between the mixture and zero air until a total of three measurements are obtained. An RF is calculated for each repetition and then averaged over the three measurements. This procedure can be repeated at several different concentration values. The data can then be used to generate a curve that relates RF to screening value. (See appendix A.)

The most accurate method for estimating RF's is to perform laboratory analysis. This is particularly true because RF's vary, not just for the detector type, but also for each individual instrument. However, in some cases, time and resource constraints may require the use of published RF data. Nevertheless, a limitation of the published data is that it is typically specific to a pure compound for a single actual concentration value, detector type, and calibration gas. Additionally, although an RF for mixtures can be calculated as described in section 2.4.2 (i.e., if an RF is known for each individual compound), the most accurate RF for a mixture is calculated by preparing known standards of air for the mixture and injecting the standard into the analyzer as described earlier.

3.2.2.2 Response Time. The response time of an analyzer is defined as the time interval from a step change in VOC concentration at the input of a sampling system, to the time at which the corresponding concentration value is reached as displayed on the analyzer readout meter. Response time is determined by introducing zero air into the instrument sample probe. When the meter reading has stabilized, the specified calibration gas is injected. The response time is measured as the time lapsed between switching to the calibration gas and the time when 90 percent of the final stable reading is obtained. This test is performed three times and the response time is calculated as the average of the three tests. The response time must be equal to or less than 30 seconds for the analyzer to be acceptable for screening purposes.

The response time test is required before placing an analyzer in service. The response time must be determined for the analyzer configuration that will be used during testing. If a modification to the sample pumping system or flow configuration is made that would change the response time (e.g., change in analyzer probe or probe filter, or the instrument pump), a new test is required before the screening survey is conducted.

3.2.2.3 Calibration Precision. Calibration precision is the degree of agreement between measurements of the same known value. To ensure that the readings obtained are repeatable, a calibration precision test must be completed before placing the analyzer in service, and at 3-month intervals, or at the next use, whichever is later. The calibration precision must be equal to or less than 10 percent of the calibration gas value.

To perform the calibration precision test, three measurements are required for each non-zero concentration. Measurements are made by first introducing zero gas and adjusting the analyzer to zero. The specified calibration gas (reference) is then introduced and the meter reading is recorded. This procedure must be performed three times. The average algebraic difference between the meter readings and the known value of the calibration gas is then computed. This average difference is then divided by

the known calibration value and multiplied by 100 to express the resulting calibration precision as percent. The calibration precision of the analyzer must be equal to or less than 10 percent of the calibration gas value.

3.2.2.4 Safety. Portable instruments to detect VOC emissions from equipment leak sources are required to be used in potentially hazardous locations such as petroleum refineries and bulk gasoline terminals. The National Electrical Code requires that instruments to be used in hazardous locations be certified to be explosion-proof, intrinsically safe, or purged.

Hazardous locations are divided into three classes: Class I, Class II, and Class III. Each class is divided into two divisions (division 1 or 2) according to the probability that a hazardous atmosphere will be present and also into seven groups, depending on the type of hazardous material exposure: Groups A through D are flammable gases or vapors, and groups E, F, and G apply to combustible or conductive gases. Class I, division 1, groups A, B, C, and D locations are those in which hazardous concentrations of flammable gases or vapors may exist under normal operating conditions. Class I, division 2, groups A, B, C, and D locations are those in which hazardous concentrations of flammable gases may exist only under unlikely conditions of operation.

Any instrument considered for use in potentially hazardous environments must be classified as intrinsically safe for Class I, division 1 and class II, division 1 conditions at a minimum. The instrument must not be operated with any safety device, such as an exhaust flame arrestor, removed.

Table 3-2 lists several portable VOC detection instruments. table 3-2 includes manufacturer, model number, pollutants detected, principle of operation, and range. Note that additional instruments, not listed here, may be available.

3.2.3 Use of Monitoring Devices That Do Not Meet EPA Reference Method 21 Requirements

In some cases, a monitoring device may not be available that meets all of the performance specifications of the EPA Reference

TABLE 3-2. PORTABLE VOC DETECTION INSTRUMENTS

Manufacturer	Model no.	Pollutant(s) detected	Principle of operation	Range (ppm)
Bacharach Instrument Co., Santa Clara, California	L	Combustible gases	Catalytic combustion	0-100% LEL ^a
	TLV Sniffer	Combustible gases	Catalytic combustion	0-1,000 and 0-10,000
Foxboro, S. Norwalk, Connecticut	OVA-128	Most organic compounds	FID/GC	0-1,000
	OVA-108	Most organic compounds	FID/GC	0-10,000
	Miran IBX	Compounds that absorb infrared radiation	NDIR	Compound specific
Health Consultants	Detecto - PAK III	Most organic compounds	FID/GC	0-10,000
HNU Systems, Inc. Newton Upper Falls, Massachusetts	HW-101	Chlorinated hydrocarbons, aromatics, aldehydes, ketones, any substance that UV light ionizes	Photoionization	0-20, 0-200, 0-2,000
Mine Safety Appliances Co., Pittsburgh, Pennsylvania	40	Combustible gases	Catalytic combustion	0-10% and 0-100% LEL ^a
Survey and Analysis, Inc., Northboro, Massachusetts	On Mark Model 5	Combustible gases	Thermal conductivity	0-5 and 0-100% LEL ^a

^aLEL = Lower explosive limit.

Method 21. For example, there are several cases (e.g., phosgene) where the RF at 10,000 ppmv is greater than 10. An instrument may meet all other requirements, but fail as a Reference Method 21 instrument because it cannot meet the RF requirement. If an instrument fails to meet Reference Method 21 requirements, it can still be used for the purpose of estimating emissions if its reliability can be documented.

Two primary steps must be taken to document the reliability of an analyzer that fails to meet the Reference Method 21 requirements. First, a laboratory program must be undertaken to demonstrate the response of the monitoring instrument to the compounds being measured; that is, an instrument response curve must be developed for the entire screening value range and documented so that screening values taken in the field can be adjusted to actual concentrations if necessary. Second, the testing program must be sufficiently well-documented to demonstrate how the instrument will be used when screening equipment. For example, if the response time of the candidate instrument exceeds the Reference Method 21 performance specification, the test plan should reflect added screening time at each potential leak point. Once this laboratory demonstration has been completed and the screening value correction curve has been established, the instrument may be used in a screening program.

3.3 THE SCREENING PROGRAM

The goal of the screening program is to measure VOC concentrations at seals, shafts, and other potential leak points. All equipment to be included in the screening survey needs to be identified before the screening program starts. A list of equipment types that are potential sources of fugitive emissions is provided in table 3-3.

3.3.1 Identification of Equipment to be Screened

The first step in the screening survey is to precisely define the process unit boundaries. This is usually straightforward, but occasionally multiple units may be built on the same pad and share some common facilities. A process unit can be defined as

TABLE 3-3. EQUIPMENT LEAK EMISSION SOURCES

<u>Equipment types</u>
Agitator seals
Compressor seals
Connectors
Diaphragms
Drains
Dump lever arms
Flanges
Hatches
Instruments
Loading arms
Meters
Open-ended lines
Polished rods
Pressure relief devices
Pump seals
Stuffing boxes
Valves
Vents
<u>Service</u>
Gas/vapor
Light liquid
Heavy liquid

the smallest set of process equipment that can operate independently and includes all operations necessary to achieve its process objective. The exact basis for the unit definition should be documented. A plot plan of the unit should be obtained and marked with the appropriate boundaries.

The next step is to obtain a simplified flow diagram of the process and note the process streams. The actual screening and data collection can be done efficiently by systematically following each stream. For example, a logical starting point would be where one of the feed lines enters the process boundary. The screening team would follow that line, screening all sources, until the line terminates at the connectors of a reactor or separation step. This approach offers the advantage of screening groups of equipment with roughly the same composition of material in the line. Screening would then continue on the outlet side of the reactor or separation equipment. Minor loops, such as a bypass around a control valve, pump, or heat exchanger, should be screened on the initial pass. Larger loops of process equipment, such as parallel passes and processing alternatives, are more effectively treated as separate streams.

Each source should be uniquely identified to indicate that it has been screened. For example, sources can be tagged. Tags can consist of any form of weatherproof and readily visible identification. Alternatively, a process unit can be considered appropriately tagged if the unit has a system of identifying markings with an associated diagram allowing easy location of marked sources. Once all the equipment along the major streams has been screened, the unit should be divided into a grid to search for fittings missed on the initial survey. Consistent with equipment leaks standards, equipment that is unsafe to monitor or very difficult to access does not need to be included in the survey. Documentation must be provided, however, to substantiate the unsafe or confined nature of such equipment.

3.3.2 Procedure for Screening

Once the equipment to be screened has been identified, the procedures outlined in the EPA Reference Method 21 to screen each equipment type are followed.¹ The probe inlet is placed at the surface of the potential leak interface where leakage could occur. (The potential leak interface is the boundary between the process fluid and the atmosphere.) For equipment with no moving parts at the leak interface, the probe should be placed directly on the leak interface; for equipment with moving parts (e.g., pumps, compressors, and agitators), the probe should be placed approximately 1 centimeter off from the leak interface. Care must be taken to ensure that the probe is held perpendicular, not tangential, to the leak potential interface; otherwise, inaccurate readings will result. The probe must then be moved along the interface periphery while observing the instrument readout. If an increased meter reading is observed, slowly move the probe along the interface where concentrations register until the maximum meter reading is obtained. The probe inlet should be left at this maximum reading location for approximately two times the instrument response time. The maximum reading is recorded as the screening value.

The instrument measurement may exceed the scale of the instrument. This is referred to as a "pegged" readout. For example, for several instruments, the highest readout on the scale is 10,000 ppmv. For the purposes of generating an emissions estimate, a dilution probe should be employed to measure concentrations greater than the instrument's normal range unless average emission factors for greater than or equal to the "pegged" readout are applied. It is important to note that extending the measurement range necessitates the calibration of the instrument to the higher concentrations.

Care should be taken to avoid fouling the probe with grease, dust, or liquids. A short piece of Teflon® tubing can be used as a probe tip extender and then can be snipped off as the tip fouls. In areas with a noticeable particulate loading, this tubing can be packed loosely with untreated fiberglass, which

acts as a filter. (Note that the instrument must also be calibrated with this filter in place.) If a surface to be screened is obviously dirty, hold the probe tip just over the surface to avoid scooping up contaminants. Some fouling is unavoidable, so it is recommended that the probe tip filter be cleaned at least daily and any other filters on a weekly basis. Normally, these filters can be cleaned by just tapping them lightly on a table top, but if the deposits are wet and caked on, they should be washed with an aqueous solution of soap and alcohol. This solution also can be used to wash the probe and transfer line periodically. Care should be taken to blow the equipment dry before reuse.

This general procedure can be used to screen equipment such as valves, connectors and flanges, pumps and compressors, open-ended lines, and other potential sources of VOC leakage, such as pressure relief devices, loading arms, stuffing boxes, instruments, vents, dump lever arms, drains, diaphragms, hatches, notes, or polished rods. The following sections describe the location on each type of equipment where screening efforts should be concentrated.

3.3.2.1 Valves. For valves, the most common source of leaks is at the seal between the stem and housing. To screen this source, the probe opening is placed where the stem exits the packing gland and is moved around the stem circumference. The maximum reading is recorded as the screening valve. Also, the probe opening is placed at the packing gland take-up connector seat, and the probe is moved along the periphery. In addition, valve housings of multipart assemblies should be screened at the surface of all points where leaks could occur. Figures 3-1 through 3-5 illustrate screening points for several different types of valves.

3.3.2.2 Connectors and Flanges. For connectors, the probe opening is placed at the outer edge of the connector - gasket interface and the circumference of the connector is sampled. For screwed connectors, the threaded connection interface must also be screened. Other types of nonpermanent joints, such as

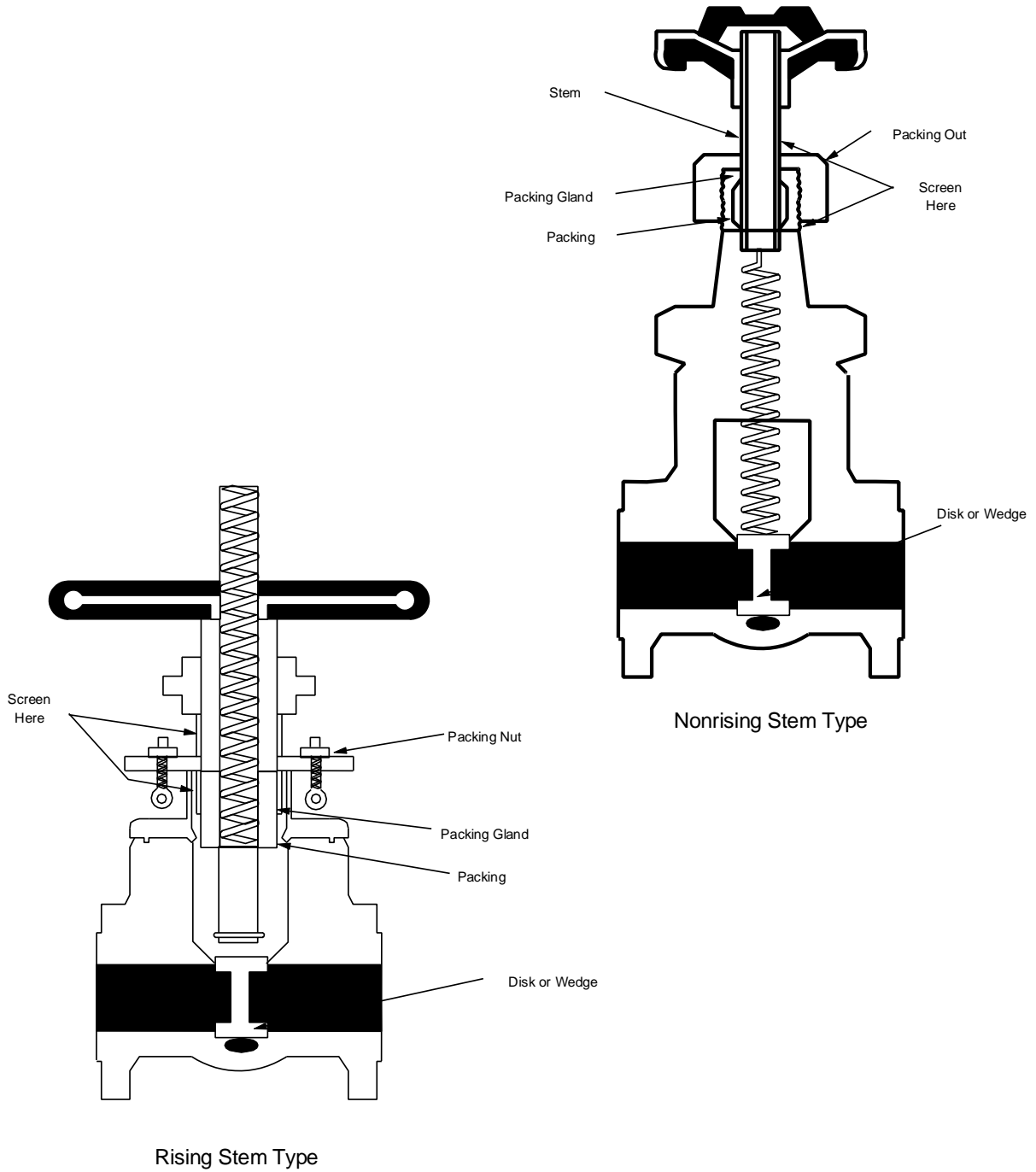
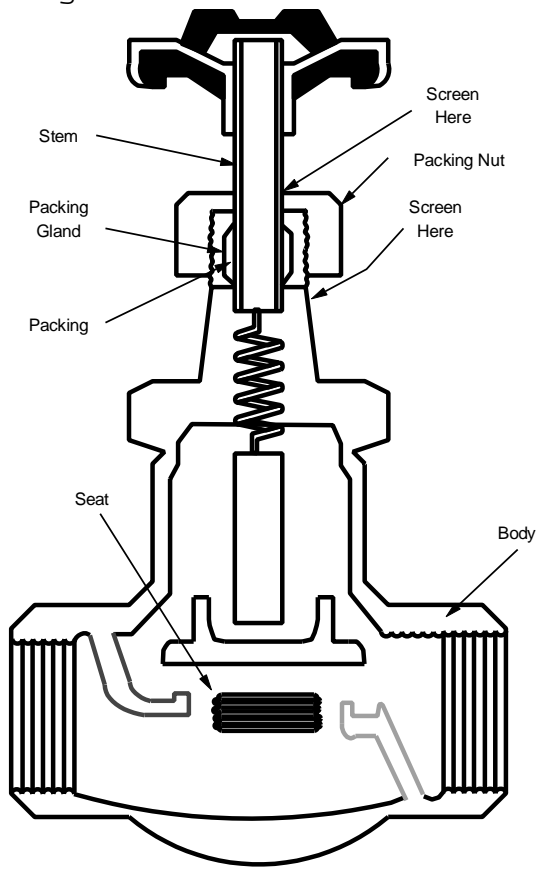
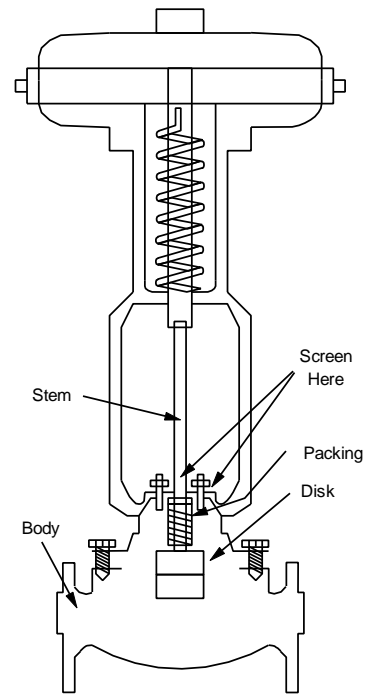

Figure 3-1. Gate Valves

through



Manual Globe Valve



Globe Type Control Valve

Figure 3-2. Globe Valves

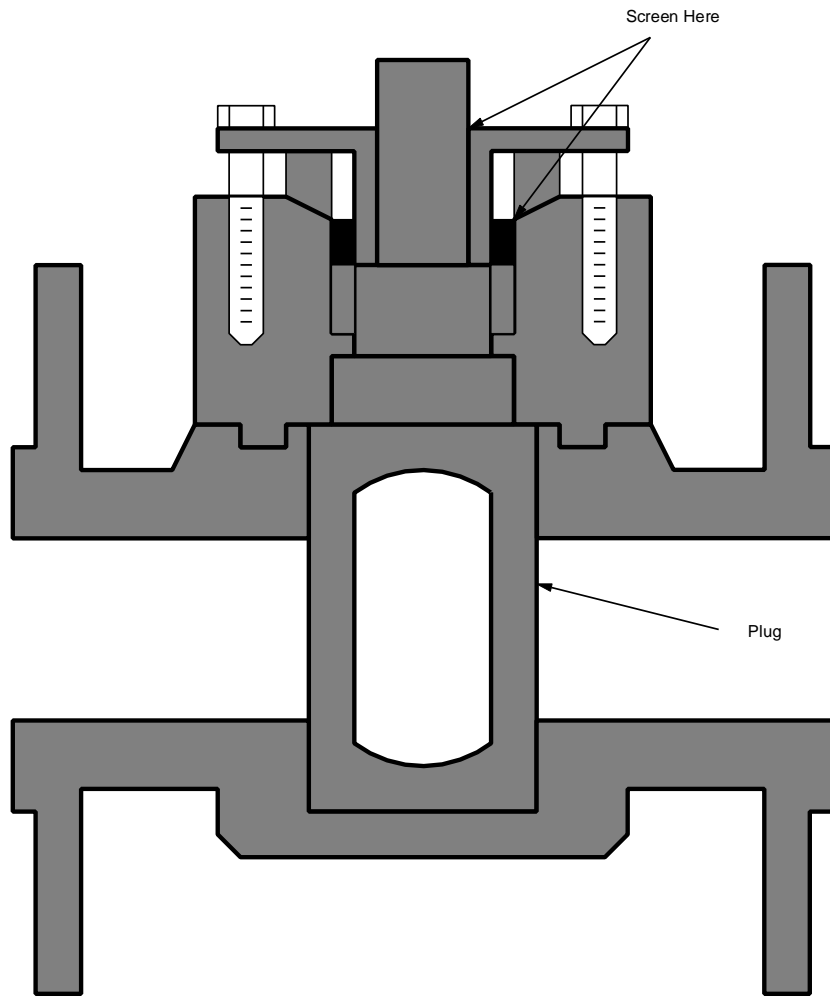
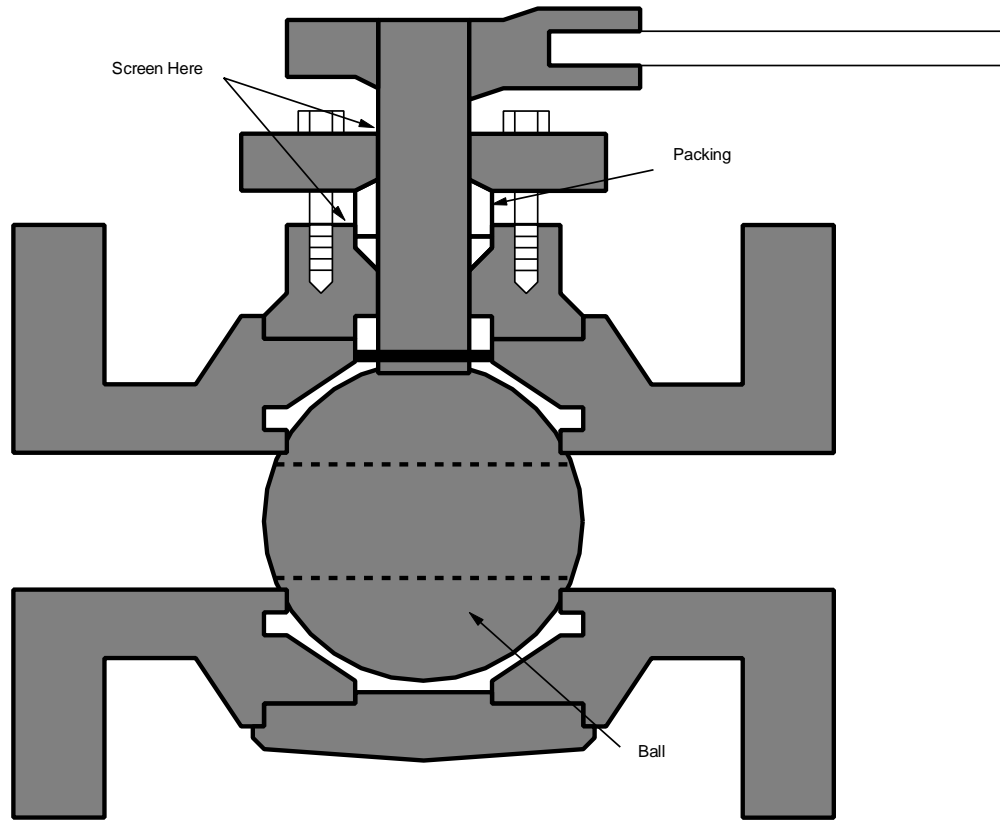
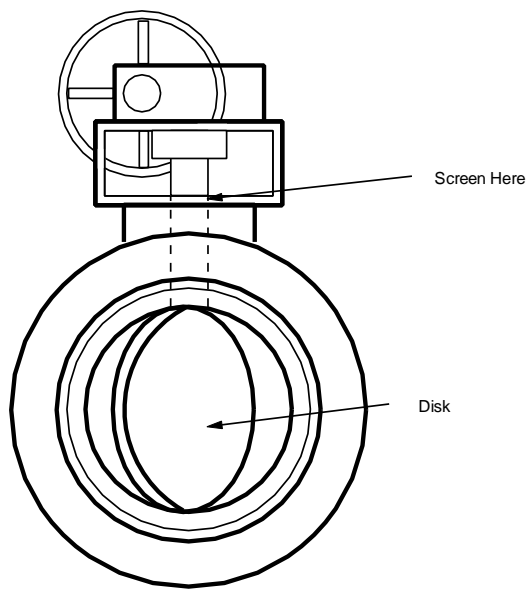

Figure 3-3. Lubricated Plug Valve



Ball Valve



Butterfly Valve

Figure 3-4. Ball Valve and Butterfly Valve

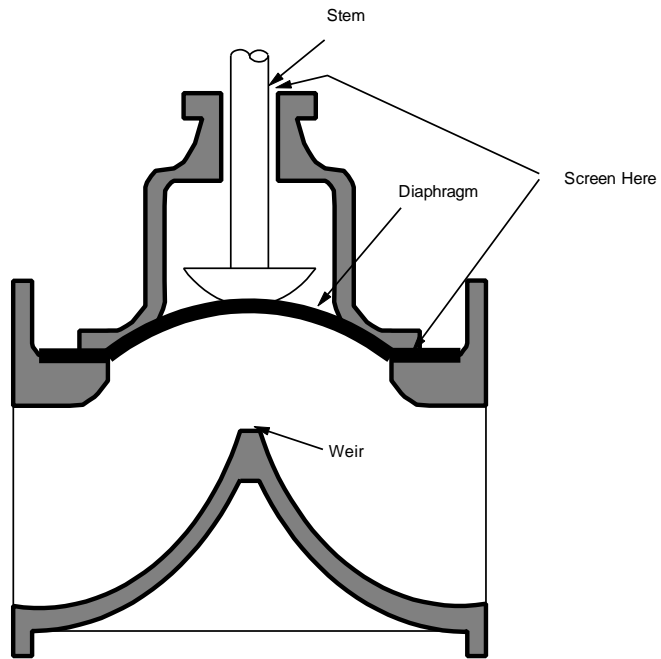

Weir-Type Diaphragm Valve

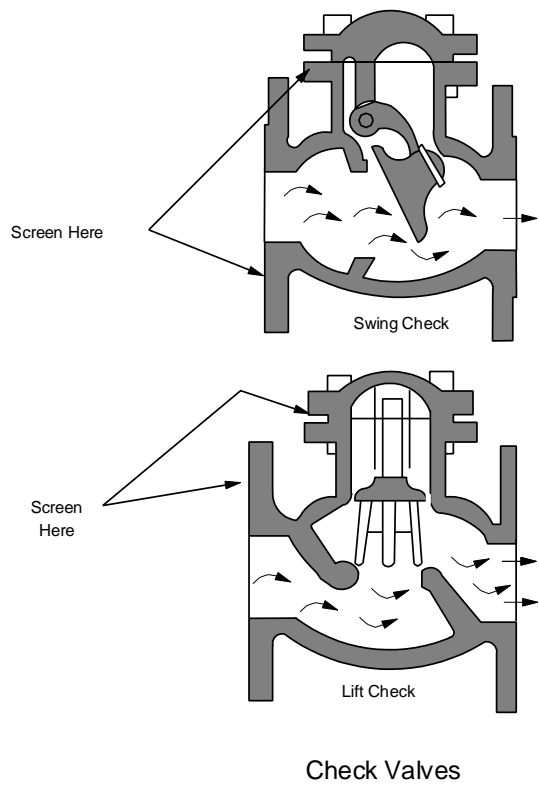

Check Valves

Figure 3-5. Weir-Type Diaphragm Valve and Check Valves

threaded connections, are sampled with a similar traverse.

3.3.2.3 Pumps, Compressors, and Agitators. Pumps, compressors, and agitators are screened with a circumferential traverse at the outer surface shaft and seal interface where the shaft exits the housing. If the source is a rotating shaft, the probe inlet is positioned within 1 centimeter of the shaft - seal interface. If the housing configuration prevents a complete traverse of the shaft periphery, all accessible portions must be sampled. All other joints on the pump or compressor housing where leakage could occur should also be sampled. Figure 3-6 illustrates screening points for two types of centrifugal pumps.

3.3.2.4 Pressure Relief Devices. The configuration of most pressure relief devices prevents sampling at the sealing seat. Because of their design and function, pressure relief devices must be approached with extreme caution. These devices should not be approached during periods of process upsets, or other times when the device is likely to activate. Similarly, care must be used in screening pressure relief devices to avoid interfering with the working parts of the device (e.g., the seal disk, the spring, etc.) For those devices equipped with an enclosed extension, or horn, the probe inlet is placed at approximately the center of the exhaust area to the atmosphere. It should be noted that personnel conducting the screening should be careful not to place hands, arms, or any parts of the body in the horn. Figure 3-7 illustrates the screening points for a spring-loaded relief valve.

3.3.2.5 Open-Ended Lines. Fugitive leaks from open-ended lines are emitted through a regularly shaped opening. If that opening is very small (as in sampling lines of less than 1 inch in diameter), a single reading in the center is sufficient. For larger openings it is necessary to traverse the perimeter of the opening. The concentration at the center must also be read.

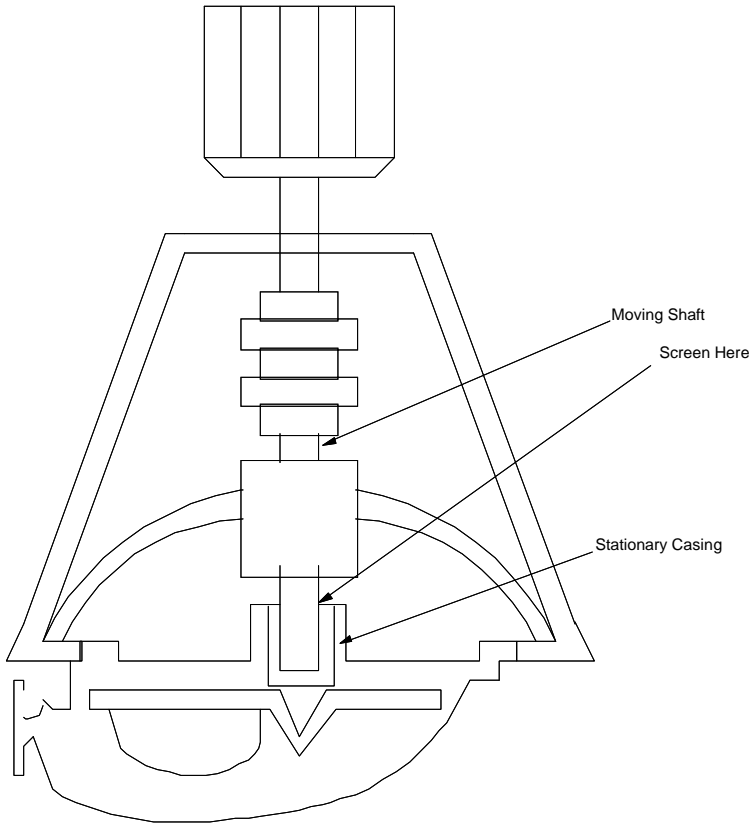

Vertical Centrifugal Pump

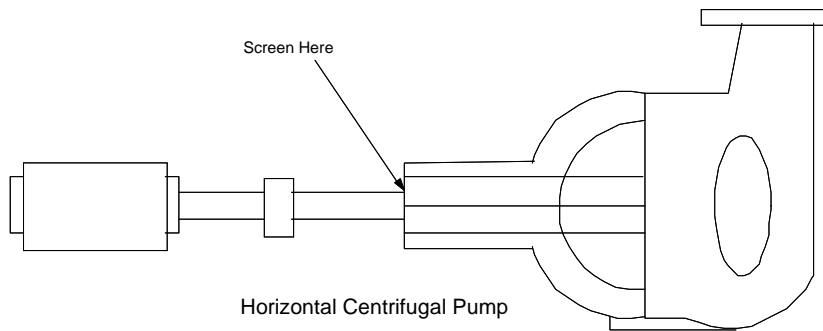

Figure 3-6. Centrifugal Pumps

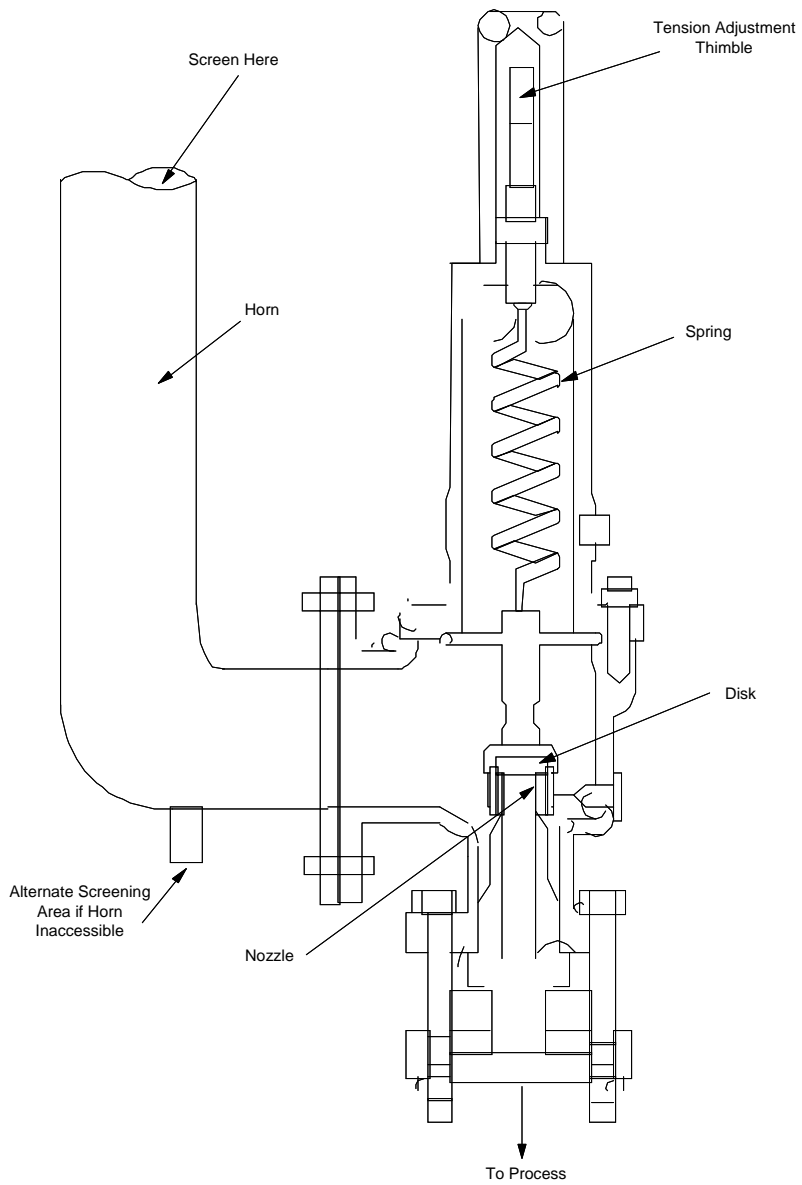

Figure 3-7. Spring-Loaded Relief Valve

3.3.3 Data Handling

To ensure that data quality is maintained, it is recommended that data be recorded on prepared data sheets. The data collected should include the following:

1. Monitoring instrument type and model number.
2. Operator's name.
3. Date.
4. Component identification number (ID number). (If permanent ID's are not in place, assign ID's as each source is screened.)
5. Component type (i.e., valve, connector, open-ended line, etc.)
6. Location/stream. (Provide brief description of where the screened component is located and the composition of material in the equipment.)
7. Service (i.e., gas, light liquid, or heavy liquid).
8. Number of hours per year the component is in service.
9. Screening value (ppmv).
10. Background concentration (ppmv).
11. Comments. If any explanation is required, it should be noted in a "comments" section.

In some cases, it may be necessary or desirable to adjust the screening values for RF. In these cases, the data sheet should be designed to accommodate extra columns for RF and corrected screening values. Table 3-4 provides an example data sheet that may be used to log measurements taken during a screening program.

3.4 REFERENCES

1. Code of Federal Regulations, Title 40, Part 60, Appendix A. Reference Method 21, Determination of Volatile Organic Compound Leaks. Washington, DC. U.S. Government Printing Office. Revised June 22, 1990.

4.0 MASS EMISSION SAMPLING

4.1 INTRODUCTION

This chapter describes the procedures for "bagging" equipment to measure mass emissions of organic compounds. An equipment component is bagged by enclosing the component to collect leaking vapors. Measured emission rates from bagged equipment coupled with screening values can be used to develop unit-specific screening value/mass emission rate correlation equations. Unit-specific correlations can provide precise estimates of mass emissions from equipment leaks at the process unit. However, it is recommended that unit-specific correlations are only developed in cases where the existing EPA correlations do not give reasonable mass emission estimates for the process unit. The focus of the chapter is on bagging equipment containing organic compounds, but similar procedures can be applied to bag equipment containing inorganic compounds as long as there are comparable analytical techniques for measuring the concentration of the inorganic compound.

This chapter is divided into four sections. In section 4.2, the methods for bagging equipment are discussed. Considerations for bagging each equipment type are discussed in section 4.3. In section 4.4, techniques used in the laboratory analysis of bagged samples are discussed. Section 4.4 also includes a description of a rigorous calibration procedure for the portable monitoring device that must be followed. Finally, in section 4.5, quality assurance and quality control (QA/QC) guidelines are provided.

4.2 SAMPLING METHODS

The emission rate from an equipment component is measured by bagging the component--that is, isolating the component from ambient air to collect any leaking compound(s). A tent (i.e., bag) made of material impermeable to the compound(s) of interest is constructed around the leak interface of the piece of equipment. A known rate of carrier gas is induced through the bag and a sample of the gas from the bag is collected and analyzed to determine the concentration (in parts per million by volume [ppmv]) of leaking material. The concentration is measured using laboratory instrumentation and procedures. Mass emissions are calculated based on the measured concentration and the flow rate of carrier gas through the bag.

In some cases, it may be necessary to collect liquid leaking from a bagged equipment piece. Liquid can either be dripping from the equipment piece prior to bagging, and/or be formed as condensate within the bag. If liquid accumulates in the bag, then the bag should be configured so that there is a low point to collect the liquid. The time in which the liquid accumulates should be recorded. The accumulated liquid should then be taken to the laboratory and transferred to a graduated cylinder to measure the volume of organic material. Based on the volume of organic material in the cylinder (with the volume of water or nonorganic material subtracted out), the density of the organic material, and the time in which the liquid accumulated, the organic liquid leak rate can be calculated. Note that the density can be assumed to be equivalent to the density of organic material in the equipment piece, or, if sufficient volume is collected, can be measured using a hydrometer. It should be noted that in some cases condensate may form a light coating on the inside surface of the bag, but will not accumulate. In these cases, it can be assumed that an equilibrium between condensation and evaporation has been reached and that the vapor emissions are equivalent to total emissions from the source.

When bagging an equipment piece, the enclosure should be kept as small as practical. This has several beneficial effects:

- The time required to reach equilibrium is kept to a minimum;
- The time required to construct the enclosure is minimized;
- A more effective seal results from the reduced seal area; and
- Condensation of heavy organic compounds inside the enclosure is minimized or prevented due to reduced residence time and decreased surface area available for heat transfer.

Two methods are generally employed in sampling source enclosures: the vacuum method and the blow-through method. Both methods involve enclosing individual equipment pieces with a bag and setting up a sampling train to collect two samples of leaking vapors to be taken to the laboratory for analysis. Both methods require that a screening value be obtained from the equipment piece prior to and after the equipment piece is enclosed. The methods differ in the ways in which the carrier gas is conveyed through the bag. In the vacuum method, a vacuum pump is used to pull air through the bag. In the blow-through method, a carrier gas such as nitrogen (or other inert gas) is blown into the bag.

In general, the blow-through method has advantages over the vacuum method. These advantages are as follows.

- (1) The blow-through method is more conducive to better mixing in the bag.
- (2) The blow-through method minimizes ambient air in the bag and thus reduces potential error associated with background organic compound concentrations. (For this reason the blow-through method is especially preferable when measuring the leak rate from components with zero or very low screening values.)
- (3) The blow-through method minimizes oxygen concentration in the bag (assuming air is not used as the carrier gas) and the risk of creating an explosive environment.
- (4) In general, less equipment is required to set up the blow-through method sampling train.

However, the blow-through method does require a carrier gas source, and preferably the carrier gas should be inert and free

of any organic compounds and moisture. The vacuum method does not require a special carrier gas.

Details of the sampling train of each of these bagging methods are discussed in sections 4.2.1 and 4.2.2, respectively. These sections also contain summaries of the steps of the sampling procedure for each method. For both methods, the approach described above for collecting and measuring liquid leak rates can be utilized. In addition to the sampling descriptions presented in the following sections, the quality control and assurance guidelines presented in section 4.5 must also be followed when bagging equipment.

4.2.1 Vacuum Method

The sampling train used in the vacuum method is depicted in figure 4-1. The train can be mounted on a portable cart, which can be moved around the process unit from component to component. The major equipment items in the sampling train are the vacuum pump used to draw air through the system, and the dry gas meter used to measure the flow rate of gas through the train. In previous studies that the EPA conducted, a 4.8-cubic feet per minute Teflon® ring piston-type vacuum pump equipped with a 3/4-horsepower, air-driven motor was used. Other equipment that may be used in the train includes valves, copper and stainless steel tubing, Teflon® tubing and tape, thermometer, pressure-reading device, liquid collection device, and air-driven diaphragm sampling pumps. It also may be necessary to use desiccant preceding the dry gas meter to remove any moisture.

The bag is connected by means of a bulkhead fitting and Teflon® tubing to the sampling train. A separate line is connected from the bag to a pressure-reading device to allow continuous monitoring of the pressure inside the bag. If a significant vacuum exists inside the bag when air is being pulled through, a hole is made in the opposite side of the bag from the outlet to the sampling train. This allows air to enter the bag more easily and, thus, reduces the vacuum in the enclosure. However, it is important to maintain a vacuum in the bag, since VOC could be lost through the hole if the bag became pressurized.

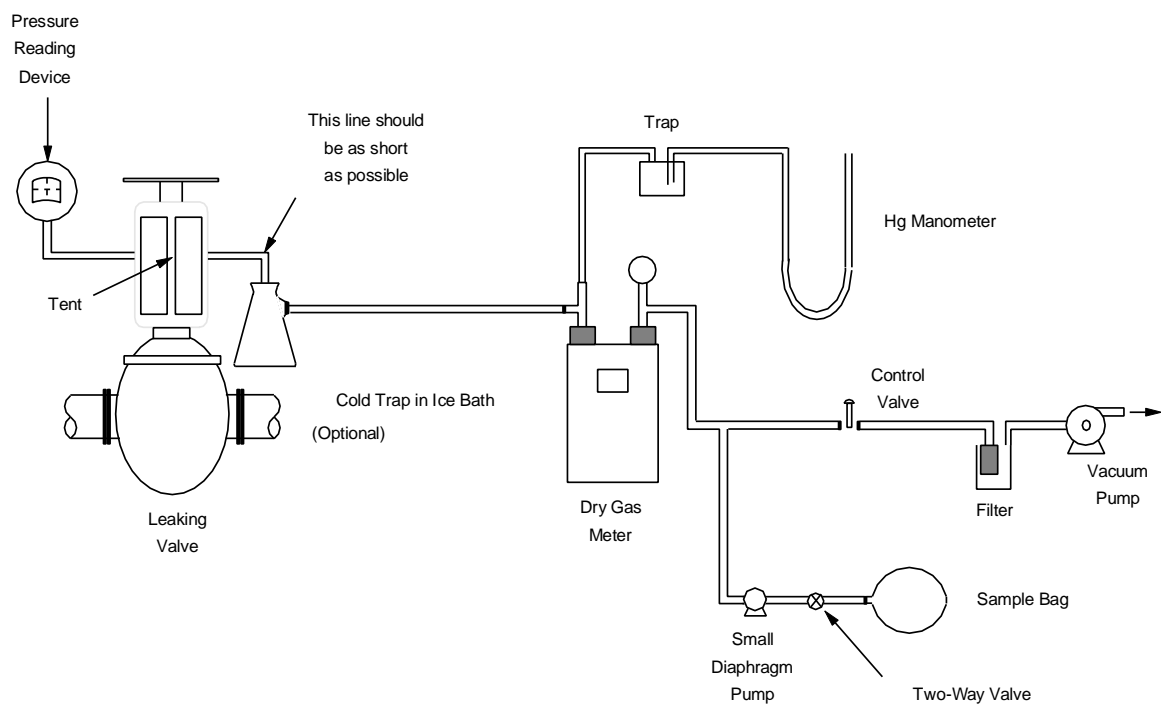

Figure 4-1. Sampling train for bagging a source using the vacuum method.

In practice, it has been found that only a very slight vacuum (0.1 inches of water) is present in the bag during most of the sampling, even in the absence of a hole through the bag wall. Sufficient air enters around the seals to prevent the development of a significant vacuum in the bag. A small diaphragm sampling pump can be used to collect two samples into sample bags or canisters, which are then transported to the laboratory for analysis.

The diaphragm pump can also be used to collect a background sample of the ambient air near the bagged component. The concentration in the background bag is subtracted from the average concentration in the sample bags when calculating the leak rate. Often this correction is insignificant (particularly for components with high leak rates or in cases where there is no detectable volatile organic compound (VOC) concentration measured by the portable monitoring device), and collection of a background bag is optional. However, in some cases collection of a background bag is important so that emission rates are not biased high.

Any liquid that accumulates in the bag should be collected using the approach described in section 4.2. Note that if there is a concern that condensation will occur in equipment downstream from the bag outlet, a cold trap can be placed as close to the bag outlet as possible to remove water or heavy organic compounds that may condense downstream. Any organic condensate that collects in the cold trap must be measured to calculate the total leak rate.

The flow rate through the system can be varied by throttling the flow with a control valve immediately upstream of the vacuum pump. Typical flow rates are approximately 60 liters per minute (ℓ/min) or less. A good flow rate to use is one in which a balance can be found between reaching equilibrium conditions and having a high enough concentration of organic compounds in the bag outlet to accurately measure the concentration in the laboratory. As the flow rate is decreased, the concentration of organic compounds increases in the gas flowing through the

sampling system. The flow rate should be adjusted to avoid any operations with an explosive mixture of organic compounds in air. It may also be possible to increase the flow rate in order to minimize liquid condensation in the bag.

The flow rate should be set to a constant rate and kept at that rate long enough for the system to reach equilibrium. To determine if equilibrium conditions have been reached, a portable monitoring device can be used to indicate if the outlet concentration has stabilized.

It is not recommended that the vacuum method be used to measure the leak rate from equipment that have low screening values (approximately 10 ppmv or less), because considerable error can be introduced due to the background organic concentration in the ambient air that is pulled through the bag.

In summary, the vacuum sampling procedure consists of the following steps.

- (1) Determine the composition of material in the designated equipment component, and the operating conditions of the component.
- (2) Obtain and record a screening value with the portable monitoring instrument.
- (3) Cut a bag from appropriate material (see section 4.3) that will easily fit over the equipment component.
- (4) Connect the bag to the sampling train.
- (5) If a cold trap is used, immerse the trap in an ice bath.
- (6) Note the initial reading of the dry gas meter.
- (7) Start the vacuum pump and a stopwatch simultaneously. Make sure a vacuum exists within the bag.
- (8) Record the temperature and pressure at the dry gas meter.
- (9) Observe the VOC concentration at the vacuum pump exhaust with the monitoring instrument. Make sure concentration stays below the lower explosive limit.
- (10) Record the temperature, pressure, dry gas meter reading, outlet VOC concentration and elapsed time every 2 to 5 minutes (min).

- (11) Collect 2 gas samples from the discharge of the diaphragm sampling pump when the outlet concentration stabilizes (i.e., the system is at equilibrium).
- (12) Collect a background bag (optional).
- (13) Collect any liquid that accumulated in the bag as well as in the cold trap (if used) in a sealed container.
- (14) Take a final set of readings and stop the vacuum pump.
- (15) Transport all samples to the laboratory, along with the data sheet.
- (16) Remove the bag.
- (17) Rescreen the source with the portable monitoring instrument and record.

Based on the data collected in the steps described above, mass emissions are calculated using the equation presented in table 4-1.

4.2.2 Blow-Through Method

The sampling train for the blow-through method is presented in figure 4-2. The temperature and oxygen concentrations are measured inside the bag with a thermocouple (or thermometer) and an oxygen/combustible gas monitor. The carrier gas is metered into the bag through one or two tubes (two tubes provide for better mixing) at a steady rate throughout the sampling period. The flow rate of the carrier gas is monitored in a gas rotameter calibrated to the gas. Typical flow rates are approximately 60 l/min or less. It is preferable to use an inert gas such as nitrogen for the blow-through method so as to minimize the risk of creating an explosive environment inside the bag. Also, the carrier gas should be free of any organic compounds and moisture. The pressure in the bag should never exceed 1 pound per square inch gauge (psig).

The flow rate through the bag can be varied by adjusting the carrier gas regulator. As mentioned in section 4.2.1, a good flow rate to use is one in which a balance can be found between reaching equilibrium conditions and having a high enough

TABLE 4-1. CALCULATION PROCEDURES FOR LEAK RATE WHEN USING THE VACUUM METHOD

$$\text{Leak Rate (kg/hr)} = \frac{9.63 \times 10^{-10} (Q)(MW)(GC)(P)}{T + 273.15} + \frac{(\rho)(V_L)}{16.67(t)}$$

where:

9.63×10^{-10} = A conversion factor using the gas constant:

$$\frac{^{\circ}\text{K} \times 10^6 \times \text{kg-mol} \times \text{min}}{\ell \times \text{hour} \times \text{mmHg}} ;$$

- Q = Flow rate out of bag (ℓ /min);
- MW^a = Molecular weight of organic compound(s) in the sample bag^c or alternatively in the process stream contained within the equipment piece being bagged (kg/kg-mol);
- GC^b = Sample bag organic compound concentration (ppmv) minus background bag organic compound concentration^c (ppmv);
- P = Absolute pressure at the dry gas meter (mmHg);
- T = Temperature at the dry gas meter ($^{\circ}$ C);
- ρ = Density of organic liquid collected (g/ml);
- V_L = Volume of liquid collected (ml);
- 16.67 = A conversion factor to adjust term to units of kilograms per hour (g \times hr)/(kg \times min)
- t = Time in which liquid is collected (min); and

^aFor mixtures calculate MW as:

$$= \frac{\sum_{i=1}^n \text{MW}_i X_i}{\sum_{i=1}^n X_i}$$

where:

- MW_i = Molecular weight of organic compound i;
 X_i = Mole fraction of organic compound i; and
 n = Number of organic compounds in mixture.

^bFor mixtures, the value of GC is the total concentration of all the organic compounds in the mixture.

^cCollection of a background bag is optional. If a background bag is not collected, assume the background concentration is zero.

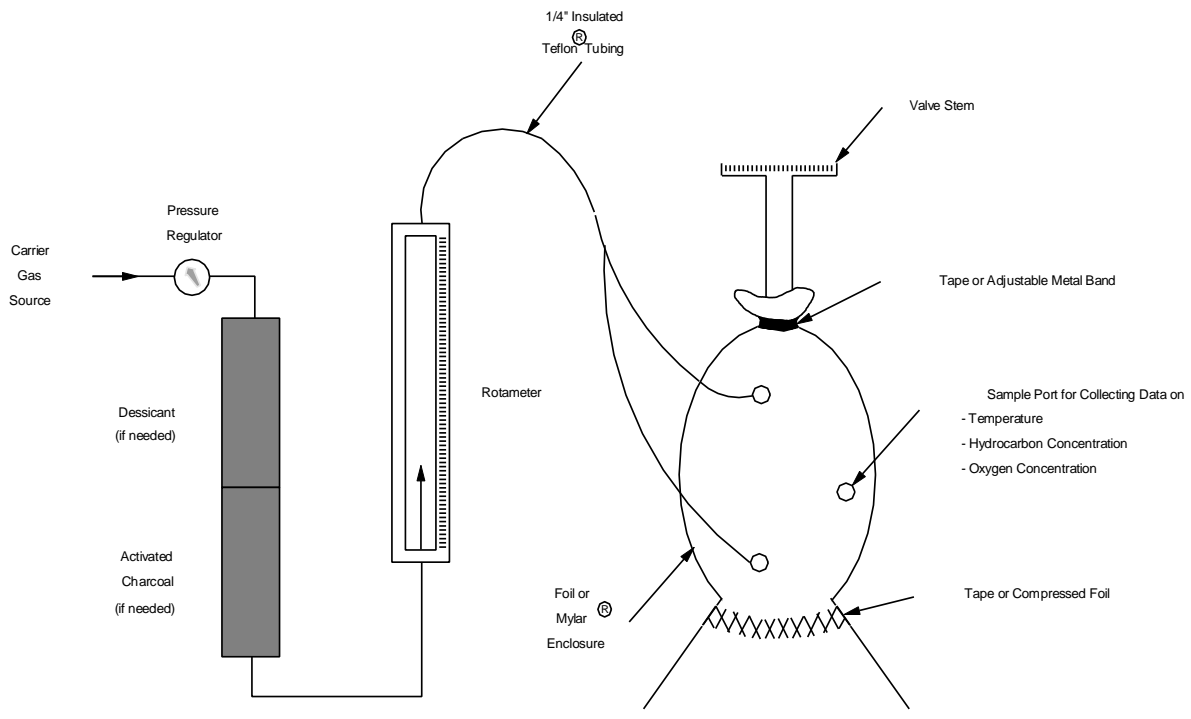

Figure 4-2. Equipment Required for the Blow-Through Sampling Technique

concentration of organic compounds in the bag outlet to accurately measure the concentration in the laboratory. Adjustments to the flow rate may also help minimize liquid condensation in the bag. Any liquid that does accumulate in the bag should be collected using the approach described in section 4.2.

The carrier gas flow rate should be set to a constant rate and kept at that rate long enough for the system to reach equilibrium. In addition to the carrier gas flow through the bag, some ambient air may enter the bag if it is not airtight. The oxygen measurements are used to determine the flow of ambient air through the bag. The oxygen measurements are also an indication of the quality of the bagging procedure (the lower the oxygen concentration the better). Once oxygen concentration falls below 5 percent, the portable monitoring instrument is used to check organic compound concentrations at several locations within the bag to ensure that the bag contents are at steady state.

Once the bag contents are at steady state, two gas samples are drawn out of the bag for laboratory analysis using a portable sampling pump. It may also be necessary to collect a background bag sample, particularly if the source had screened at zero and if there is still a detectable level of oxygen in the bag. However, collection of a background bag is optional.

In summary, the blow-through method consists of the following steps, which assume nitrogen is used as the carrier gas.

- (1) Determine the composition of the material in the designated equipment component, and the operating conditions of the component.
- (2) Screen the component using the portable monitoring instrument.
- (3) Cut a bag that will easily fit over the equipment component.

- (4) Connect tubing from the nearest nitrogen source to a rotameter stand.
- (5) Run tubing from the rotameter outlet to a "Y" that splits the nitrogen flow into two pieces of tubing and insert the tubes into openings located on either side of the bag.
- (6) Turn on the nitrogen flow and regulate it at the rotameter to a constant rate and record the time.
- (7) After the nitrogen is flowing, wrap aluminum foil around those parts of the component where air could enter the bag-enclosed volume.
- (8) Use duct tape, wire, and/or rope to secure the bag to the component.
- (9) Put a third hole in the bag roughly equidistant from the two carrier gas-fed holes.
- (10) Measure the oxygen concentration in the bag by inserting the lead from an oxygen meter into the third hole. Adjust the bag (i.e., modify the seals at potential leak points) until the oxygen concentration is less than 5 percent.
- (11) Measure the temperature in the bag.
- (12) Check the organic compound concentration at several points in the bag with the portable monitoring instrument to ensure that carrier gas and VOC are well mixed throughout the bag.
- (13) Collect samples in sample bags or canisters by drawing a sample out of the bag with a portable sampling pump.
- (14) Collect a background bag (optional).
- (15) Remove the bag and collect any liquid that accumulated in the bag in a sealed container. Note the time over which the liquid accumulated.
- (16) Rescreen the source.

Table 4-2 gives equations used to calculate mass emission rates when using the blow-through method. An adjustment is provided for the leak rate equation in table 4-2 to account for the total flow through the bag. This adjustment is recommended and represents an improvement over previous versions

TABLE 4-2. CALCULATION PROCEDURES FOR LEAK RATE
WHEN USING THE BLOW-THROUGH METHOD

$$\text{Leak Rate (kg/hr)} = \left(\frac{1.219 \times 10^{-5} (Q) (MW) (GC)}{T + 273.15} + \frac{(\rho) (V_L)}{16.67 (t)} \right) \times \left(\frac{10^6 \text{ppmv}}{10^6 \text{ppmv-GC}} \right)$$

where:

1.219×10^{-5} = A conversion factor taking into account the gas constant and assuming a pressure in the tent of 1 atmosphere:

$$\frac{^{\circ}\text{K} \times 10^6 \times \text{kg-mol}}{\text{m}^3} ;$$

Q = flow rate out of tent (m^3/hr);

$$= \frac{\text{N}_2 \text{ Flow Rate (l/min)}}{1 - [\text{Tent Oxygen Conc. (volume \%)/21]} \times \frac{[0.06 (\text{m}^3/\text{min})]}{(\text{l/hr})}$$

MW^a = Molecular weight of organic compounds in the sample bag or alternatively in the process stream contained within the equipment piece being bagged (kg/kg-mol);

GC^b = Sample bag organic compound concentration (ppmv), corrected for background bag organic compound concentration (ppmv);^c

T = Temperature in tent ($^{\circ}\text{C}$);

ρ = Density of organic liquid collected (g/ml);

V_L = Volume of liquid collected (ml);

16.67 = A conversion factor to adjust term to units of Kilograms per hour ($\text{g} \times \text{hr}/(\text{kg} \times \text{min})$); and

t = Time in which liquid is collected (min).

^aFor mixtures calculate MW as:

$$= \frac{\sum_{i=1}^n MW_i X_i}{\sum_{i=1}^n X_i}$$

where:

MW_i = Molecular weight of organic compound i ;

TABLE 4-2. CALCULATION PROCEDURES FOR LEAK RATE
WHEN USING THE BLOW-THROUGH METHOD
(Continued)

X_i = Mole fraction of organic compound i ; and
 n = Number of organic compounds in mixture.

^bFor mixtures, the value of GC is the total concentration of all the organic compounds in the mixture.

^cCollection of a background bag is optional. If a background bag is not collected, assume the background concentration is zero. To correct for background concentration, use the following equation:

$$\text{GC (ppmv)} = \text{SB} - \left(\frac{\text{TENT}}{21} \times \text{BG} \right)$$

where:

SB = Sample bag concentration (ppmv);
TENT = Tent oxygen concentration (volume %); and
BG = Background bag concentration (ppmv)

of this document for quantifying mass emissions from the blow through method.

4.3 SOURCE ENCLOSURE

In this section, choosing a bagging material and the approach for bagging specific equipment types are discussed. An important criteria when choosing the bagging material is that it is impermeable to the specific compounds being emitted from the equipment piece. This criteria is also applicable for sample gas bags that are used to transport samples to the laboratory. A bag stability test over time similar to the Flexible Bag Procedure described in section 5.3.2 of the EPA method 18 is one way to check the suitability of a bagging material.¹ After a bag has been used, it must be purged. Bags containing residual organic compounds that cannot be purged should be discarded. Mylar®, Tedlar®, Teflon®, aluminum foil, or aluminized Mylar® are recommended potential bagging materials. The thickness of the bagging material can range from 1.5 to 15 millimeters (mm), depending on the bagging configuration needed for the type of equipment being bagged, and the bagging material. Bag construction for individual sources is discussed in sections 4.3.1 through 4.3.5. For convenience, Mylar® will be used as an example of bagging material in the following discussions.

4.3.1 Valves

When a valve is bagged, only the leak points on the valve should be enclosed. Do not enclose surrounding flanges. The most important property of the valve that affects the type of enclosure selected for use is the metal skin temperature where the bag will be sealed. At skin temperatures of approximately 200 °C or less, the valve stem and/or stem support can be wrapped with 1.5- to 2.0-mm Mylar® and sealed with duct tape at each end and at the seam. The Mylar® bag must be constructed to enclose the valve stem seal and the packing gland seal.

When skin temperatures are in excess of 200 °C, a different method of bagging the valve should be utilized. Metal bands, wires, or foil can be wrapped around all hot points that would be

in contact with the Mylar® bag material. Seals are then made against the insulation using duct tape or adjustable metal bands of stainless steel. At extremely high temperatures, metal foil can be used as the bagging material and metal bands used to form seals. At points where the shape of the equipment prevent a satisfactory seal with metal bands, the foil can be crimped to make a seal.

4.3.2 Pumps and Agitators

As with valves, a property of concern when preparing to sample a pump or agitator is the metal skin temperature at areas or points that are in contact with the bag material. At skin temperatures below 200 °C, Mylar® plastic and duct tape are satisfactory materials for constructing a bag around a pump or agitator seal. If the temperature is too high or the potential points of contact are too numerous to insulate, an enclosure made of aluminum foil can be constructed. This enclosure is sealed around the pump and bearing housing using silicone fabric insulating tape, adjustable metal bands, or wire.

The configuration of the bag will depend upon the type of pump. Most centrifugal pumps have a housing or support that connects the pump drive (or bearing housing) to the pump itself. The support normally encloses about one-half of the area between the pump and drive motor, leaving open areas on the sides. The pump can be bagged by cutting panels to fit these open areas. These panels can be made using thicker bagging material such as 14-mm Mylar®. In cases where supports are absent or quite narrow, a cylindrical enclosure around the seal can be made so that it extends from the pump housing to the motor or bearing support. As with the panels, this enclosure should be made with thicker bagging material to provide strength and rigidity.

Reciprocating pumps can present a somewhat more difficult bagging problem. If supports are present, the same type of two-panel Mylar® bag can be constructed as that for centrifugal pumps. In many instances, however, sufficiently large supports are not provided, or the distance between pump and driver is relatively long. In these cases, a cylindrical enclosure as

discussed above can be constructed. If it is impractical to extend the enclosure all the way from the pump seal to the pump driver, a seal can be made around the reciprocating shaft. This can usually be best completed by using heavy aluminum foil and crimping it to fit closely around the shaft. The foil is attached to the Mylar® plastic of the enclosure and sealed with the duct tape.

In cases where liquid is leaking from a pump, the outlet from the bag to the sampling train should be placed at the top of the bag and as far away from spraying leaks as practical. A low point should be formed in the bag to collect the liquid so that the volume of the liquid can be measured and converted to a mass rate.

4.3.3 Compressors

In general, the same types of bags that are suitable for pumps can be directly applied to compressors. However, in some cases, compressor seals are enclosed and vented to the atmosphere at a high-point vent. If the seals are vented to a high-point vent, this vent line can be sampled. A Mylar® bag can be constructed and sealed around the outlet of the vent and connected to the sampling train. If the high-point vents are inaccessible, the vent lines from the compressor seal enclosures can be disconnected at some convenient point between the compressor and the normal vent exit. Sampling is then conducted at this intermediate point. In other cases, enclosed compressor seals are vented by means of induced draft blowers or fans. In these cases, if the air flow rate is known or can be determined, the outlet from the blower/fan can be sampled to determine the emission rate.

4.3.4 Connectors

In most cases, the physical configurations of connectors lend themselves well to the determination of leak rates. The same technique can be used for a connector whether it is a flanged or a threaded fitting. To bag a connector with a skin temperature below 200 °C, a narrow section of Mylar® film is constructed to span the distance between the two flange faces or

the threaded fitting of the leaking source. The Mylar® is attached and sealed with duct tape. When testing connectors with skin temperatures above 200 °C, the outside perimeter of both sides of the connector are wrapped with heat-resistant insulating tape. Then, a narrow strip of aluminum foil can be used to span the distance between the connection. This narrow strip of foil can be sealed against the insulating tape using adjustable bands of stainless steel.

4.3.5 Relief Valves

Relief devices in gas/vapor service generally relieve to the atmosphere through a large-diameter pipe that is normally located at a high point on the process unit that it serves. The "horns" can be easily bagged by placing a Mylar® plastic bag over the opening and sealing it to the horn with duct tape. Because many of these devices are above grade level, accessibility to the sampling train may be limited or prevented. It is sometimes possible to run a long piece of tubing from the outlet connection on the bag to the sampling train located at grade level or on a stable platform.

As discussed previously in section 3.0, the purpose of pressure relief devices makes them inherently dangerous to sample, especially over a long period of time. If these equipment are to be sampled for mass emissions, special care and precautions should be taken to ensure the safety of the personnel conducting the field sampling.

4.4 ANALYTICAL TECHNIQUES

The techniques used in the laboratory analysis of the bagged samples will depend on the type of processes sampled. The following sections describe the analytical instrumentation and calibration, and analytical techniques for condensate. These are guidelines and are not meant to be a detailed protocol for the laboratory personnel. Laboratory personnel should be well-versed in the analysis of organic compound mixtures and should design their specific analyses to the samples being examined.

Also discussed is the calibration protocol for the portable monitoring instrument. When bagging data are collected, it is

critical that the screening value associated with mass emission rates is accurate. For this reason, a more rigorous calibration of the portable monitoring instrument is required than if only screening data are being collected.

4.4.1 Analytical Instrumentation

The use of analytical instrumentation in a laboratory is critical to accurately estimate mass emissions. The analytical instrument of choice depends on the type of sample being processed. Gas chromatographs (GC's) equipped with a flame ionization detector or electron capture detector are commonly used to identify individual constituents of a sample. Other considerations besides instrument choice are the type of column used, and the need for temperature programming to separate individual constituents in the process stream with sufficient resolution. For some process streams, total hydrocarbon analyses may be satisfactory.

4.4.2 Calibration of Analytical Instruments

Gas chromatographs should be calibrated with either gas standards generated from calibrated permeation tubes containing individual VOC components, or bottled standards of common gases. Standards must be in the range of the concentrations to be measured. If cylinder calibration gas mixtures are used, they must be analyzed and certified by the manufacturer to be within ± 2 percent accuracy, and a shelf life must be specified. Cylinder standards beyond the shelf life must either be reanalyzed or replaced.

Field experience indicates that certified accuracies of ± 2 percent are difficult to obtain for very low-parts per million (ppm) calibration standards (< 10 ppm). Users of low-parts per million calibration standards should strive to obtain calibration standards that are as accurate as possible. The accuracy must be documented for each concentration standard.

The results of all calibrations should be recorded on prepared data sheets. Table 4-3 provides an example of a data collection form for calibrating a GC. If other analytical instruments are used to detect the organic compounds from liquid

samples, they should be calibrated according to standard calibration procedures for the instrument.

4.4.3 Analytical Techniques for Condensate

Any condensate collected should be brought to the laboratory sealed in the cold trap flask. This material is transferred to a graduated cylinder to measure the volume collected. If there is enough volume to make it feasible, the organic layer should be separated from the aqueous layer (if present) and weighed to determine its density. If water-miscible organic compounds are present, both the aqueous and organic phases should be analyzed by GC to determine the total volume of organic material.

4.4.4. Calibration Procedures for the Portable Monitoring Instrument

To generate precise screening values, a rigorous calibration of the portable monitoring instrument is necessary. Calibrations must be performed at the start and end of each working day, and the instrument reading must be within 10 percent of each of the calibration gas concentrations. A minimum of five calibration gas standards must be prepared including a zero gas standard, a standard approaching the maximum readout of the screening instrument, and three standards between these values. If the monitoring instrument range is from 0 to 10,000 ppmv, the following calibration gases are required:

- A zero gas (0-0.2 ppm) organic in air standard;
- A 9.0 ppm (8-10 ppm) organic in air standard;
- A 90 ppm (80-100 ppm) organic in air standard;
- A 900 ppm (800-1,000 ppm) organic in air standard; and
- A 9,000 ppm (8,000-10,000 ppm) organic in air standard.

The same guidelines for the analysis and certification of the calibration gases as described for calibrating laboratory analytical instruments must be followed for calibrating the portable monitoring instrument.

4.5 QUALITY CONTROL AND QUALITY ASSURANCE GUIDELINES

To ensure that the data collected during the bagging program is of the highest quality, the following QC/QA procedures must be followed. Quality control requirements include procedures to be

followed when performing equipment leak mass emissions sampling. Quality assurance requirements include accuracy checks of the instrumentation used to perform mass emissions sampling. Each of these QC/QA requirements are discussed below.

4.5.1 Quality Control Procedures

A standard data collection form must be prepared and used when collecting data in the field. Tables 4-4 and 4-5 are examples of data collection forms for the blow-through and vacuum methods of mass emissions sampling, respectively.

In addition to completing the data collection forms, the following guidelines need to be adhered to when performing the bagging analysis:

- Background levels near equipment that is selected for bagging must not exceed 10 ppmv, as measured with the portable monitoring device.
- Screening values for equipment that is selected for bagging must be readable within the spanned range of the monitoring instruments. If a screening value exceeds the highest reading on the meter (i.e., "pegged reading"), a dilution probe should be used, or in the event that this is not possible, the reading should be identified as pegged.
- Only one piece of equipment can be enclosed per bag; a separate bag must be constructed for each equipment component.
- A separate sample bag must be used for each equipment component that is bagged. Alternatively, bags should be purged and checked for contamination prior to reuse.
- A GC must be used to measure the concentrations from gas samples.
- Gas chromatography analyses of bagged samples must follow the analytical procedures outlined in the EPA method 18.
- To ensure adequate mixing within the bag when using the blow-through method, the dilution gas must be directed onto the equipment leak interface.
- To ensure that steady-state conditions exist within the bag, wait at least five time constants (volume of bag dilution/gas flow rate) before withdrawing a sample for recording the analysis.

TABLE 4-4. EXAMPLE DATA COLLECTION FORM FOR FUGITIVE EMISSIONS
BAGGING TEST (BLOW-THROUGH METHOD)

Equipment Type _____	Component ID _____
Equipment Category _____	Plant ID _____
Line Size _____	Date _____
Stream Phase (G/V, LL, HL) _____	Analysis Team _____
Barometric Pressure _____	_____
Ambient Temperature _____	Instrument ID _____
Stream Temperature _____	Stream Pressure _____
Stream Composition (Wt %) _____, _____	
_____ , _____ , _____	

<u>Time</u>	<u>Bagging Test Measurement Data</u>
_____	Initial Screening (ppmv) Equipment Piece _____ Bkgd. _____
_____	Background Bag Organic Compound Conc. (ppmv) ^a _____
_____	Dilution Gas Flow Rate (ℓ/min) _____
_____	Sample Bag 1 Organic Compound Conc. (ppmv) _____
_____	O ₂ Concentration (volume %) _____
_____	Bag Temperature (°C) _____
_____	Dilution Gas Flow Rate (ℓ/min) _____
_____	Sample Bag 2 Organic Compound Conc. (ppmv) _____
_____	O ₂ Concentration (volume %) _____
_____	Bag Temperature (°C) _____
Condensate Accumulation: Starting Time _____ Final Time _____	
Organic Condensate Collected (ml) _____	
Density of Organic Condensate (g/ml) _____	
_____	Final Screening (ppmv) Equipment Piece _____ Bkgd. _____

^aCollection of a background bag is optional. However, it is recommended in cases where the screening value is less than 10 ppmv and there is a detectable oxygen level in the bag.

TABLE 4-5. EXAMPLE DATA COLLECTION FORM FOR FUGITIVE EMISSIONS
BAGGING TEST (VACUUM METHOD)

Equipment Type _____	Component ID _____
Equipment Category _____	Plant ID _____
Line Size _____	Date _____
Stream Phase (G/V, LL, HL) _____	Analysis Team _____
Barometric Pressure _____	_____
Ambient Temperature _____	Instrument ID _____
Stream Temperature _____	Stream Pressure _____
Stream Composition (Wt %) _____	_____
_____	_____

<u>Time</u>	<u>Bagging Test Measurement Data</u>
_____	Initial Screening (ppmv) Equipment Piece ^a _____ Bkgd. _____
_____	Background Bag Organic Compound Conc. (ppmv) ^b _____
_____	Dry Gas Meter Reading (ℓ/min) _____
_____	Sample Bag 1 Organic Compound Conc. (ppmv) _____
_____	Vacuum Check in Bag (Y/N) (Must be YES to collect sample.)
_____	Dry Gas Meter Temperature ^c (°C) _____
_____	Dry Gas Meter Pressure ^c (mmHg) _____
_____	Dry Gas Meter Reading (ℓ/min) _____
_____	Sample Bag 2 Organic Compound Conc. (ppmv) _____
_____	Vacuum Check in Bag (Y/N) (Must be YES to collect sample.)
_____	Dry Gas Meter Temperature ^c (°C) _____
_____	Dry Gas Meter Pressure ^c (mmHg) _____
Condensate Accumulation: Starting Time _____ Final Time _____	
Organic Condensate Collected (ml) _____	
Density of Organic Condensate (g/ml) _____	
_____	Final Screening (ppmv) Equip. Piece ^a _____ Bkgd. _____

^aThe vacuum method is not recommended if the screening value is approximately 10 ppmv or less.

^bCollection of a background bag is optional.

^cPressure and temperature are measured at the dry gas meter.

- The carrier gas used in the blow-through method of bagging should be analyzed by GC before it is used, and the concentration of organic compounds in the sample should be documented. For cylinder purge gases, one gas sample should be analyzed. For plant purge gas systems, gas samples should be analyzed with each bagged sample unless plant personnel can demonstrate that the plant gas remains stable enough over time to allow a one-time analysis.
- The portable monitoring instrument calibration procedure described in section 4.4.4 should be performed at the beginning and end of each day.

4.5.2 Quality Assurance Procedures

Accuracy checks on the laboratory instrumentation and portable monitoring device must be performed to ensure data quality. These checks include a leak rate check performed in the laboratory, blind standards to be analyzed by the laboratory instrumentation, and drift checks on the portable monitoring device.

4.5.2.1 Leak Rate Check

A leak rate check is normally performed in the laboratory by sampling an artificially induced leak rate of a known gas. This can clarify the magnitude of any bias in the combination of sampling/test method, and defines the variance in emissions estimation due to the sampling. If the result is outside the 80 to 120 percent recovery range, the problem must be investigated and corrected before sampling continues. The problems and associated solutions should be noted in the test report.

Leak rate checks should be performed at least two times per week during the program. The leak rate checks should be conducted at two concentrations: (1) within the range of 10 multiplied by the calculated lower limit of detection for the laboratory analytical instrument; and (2) within 20 percent of the maximum concentration that has been or is expected to be detected in the field during the bagging program.

To perform a leak rate check, first induce a known flow rate with one of the known gas concentrations into a sampling bag.

For example, this can be done using a gas permeation tube of a known organic compound constituent. Next, determine the concentration of the gas using a laboratory analytical instrument and compare the results to the known gas concentration.

If the calculated leak rate is not within ± 20 percent of the induced leak rate, further analysis should be performed to determine the reason.

Areas that can potentially induce accuracy problems include:

- Condensation,
- Pluggage,
- Seal of bag not tight (leakage),
- Adsorption onto bag, and
- Permeation of bag.

The results of all accuracy checks should be recorded on prepared data sheets.

4.5.2.2 Blind Standards Preparation and Performance

Blind standards are analyzed by the laboratory instrumentation to ensure that the instrument is properly calibrated. Blind standards must be prepared and submitted at least two times per week during the program. The blind standards are prepared by diluting or mixing known gas concentrations in a prescribed fashion so that the resulting concentrations are known. The analytical results should be within ± 25 percent of the blind standard gas concentration. If the results are not within 25 percent of the blind standard concentration, further analyses must be performed to determine the reason. Use of blind standards not only defines the analytical variance component and analytical accuracy, but it can serve to point out equipment malfunctions and/or operator error before questionable data are generated.

4.5.2.3 Drift Checks

Drift checks need to be performed to ensure that the portable monitoring instrument remains calibrated. At a minimum, drift checks must be performed before and after a small group of components (i.e., two or three) are bagged. Preferably, drift

checks should be performed on the screening instrument immediately before and after each component is bagged. These checks should be performed by analyzing one of the calibration gases used to calibrate the portable monitoring instrument. The choice of calibration gas concentration should reflect the anticipated screening value of the next component to be monitored. For example, if a component had previously screened at 1,000 ppmv and been identified for bagging, the calibration standard should be approximately 900 ppmv.

Drift check data must be recorded on data sheets containing the information shown in the example in table 4-6. If the observed instrument reading is different from the certified value by greater than ± 20 percent, then a full multipoint calibration must be performed (see section 3.2.4.1). Also, all those components analyzed since the last drift check must be retested.

Drift checks should also be performed if flameout of the portable monitoring instrument occurs. Using the lowest calibration gas standard (i.e., approximately 9 ppmv standard), determine the associated response on the portable monitoring instrument. If the response is not within ± 10 percent of the calibration gas concentration, a full multipoint calibration is required before testing resumes.

4.6 REFERENCES

1. Code of Federal Regulations, Title 40, Part 60, Appendix A. Reference Method 21, Determination of Volatile Organic Compound Leaks. Washington, DC. U.S. Government Printing Office. Revised June 22, 1990.

5.0 ESTIMATION OF CONTROL EFFICIENCIES FOR EQUIPMENT LEAK CONTROL TECHNIQUES

5.1 INTRODUCTION

In this chapter, control techniques for reducing equipment leak emissions are described. There are two primary techniques for reducing equipment leak emissions: (1) modifying or replacing existing equipment, and (2) implementing a leak detection and repair (LDAR) program.

Modifying or replacing existing equipment is referred to in this chapter as an "equipment modification." Examples of equipment modifications include installing a cap on an open-ended line, replacing an existing pump with a sealless type, and installing on a compressor a closed-vent system that collects potential leaks and routes them to a control device. In section 5.2, possible equipment modifications for each of the equipment types are briefly described. Also, the estimated control efficiency is presented for each equipment modification.

An LDAR program is a structured program to detect and repair equipment that is identified as leaking. The focus of this chapter is LDAR programs for which a portable monitoring device is used to identify equipment leaks from individual pieces of equipment. In section 5.3, an approach is presented for estimating the control effectiveness of an LDAR program.

5.2 EQUIPMENT MODIFICATION CONTROL EFFICIENCY

Controlling emissions by modifying existing equipment is achieved by either installing additional equipment that eliminates or reduces emissions, or replacing existing equipment with sealless types. Equipment modifications for each equipment type are described in the following sections. A separate section

is included on closed-vent systems, which can be installed on more than one type of equipment. Equipment modifications that can be used for each equipment type are summarized in table 5-1. Table 5-1 also contains an approximate control efficiency for each modification.

5.2.1 Closed-Vent Systems

A closed-vent system captures leaking vapors and routes them to a control device. The control efficiency of a closed-vent system depends on the percentage of leaking vapors that are routed to the control device and the efficiency of the control device. A closed-vent system can be installed on a single piece of equipment or on a group of equipment pieces. For use on single pieces of equipment, closed-vent systems are primarily applicable to equipment types with higher potential emission rates, such as pumps, compressors, and pressure relief devices.

5.2.2 Pumps

Equipment modifications that are control options for pumps include routing leaking vapors to a closed-vent system (as discussed in section 5.2.1), installing a dual mechanical seal containing a barrier fluid, or replacing the existing pump with a sealless type.

5.2.2.1 Dual Mechanical Seals. A dual mechanical seal contains two seals between which a barrier fluid is circulated. Depending on the design of the dual mechanical seal, the barrier fluid can be maintained at a pressure that is higher than the pumped fluid or at a pressure that is lower than the pumped fluid. If the barrier fluid is maintained at a higher pressure than the pumped fluid, the pumped fluid will not leak to the atmosphere. The control efficiency of a dual mechanical seal with a barrier fluid at a higher pressure than the pumped fluid is essentially 100 percent, assuming both the inner and outer seal do not fail simultaneously.

If the barrier fluid is maintained at a lower pressure than the pumped fluid, a leak in the inner seal would result in the pumped fluid entering the barrier fluid. To prevent emissions of the pumped fluid to the atmosphere, a barrier fluid reservoir

TABLE 5-1. SUMMARY OF EQUIPMENT MODIFICATIONS

Equipment type	Modification	Approximate control efficiency (%)
Pumps	Sealless design	100 ^a
	Closed-vent system	90 ^b
	Dual mechanical seal with barrier fluid maintained at a higher pressure than the pumped fluid	100
Compressors	Closed-vent system	90 ^b
	Dual mechanical seal with barrier fluid maintained at a higher pressure than the compressed gas	100
Pressure relief devices	Closed-vent system	c
	Rupture disk assembly	100
Valves	Sealless design	100 ^a
Connectors	Weld together	100
Open-ended lines	Blind, cap, plug, or second valve	100
Sampling connections	Closed-loop sampling	100

^aSealless equipment can be a large source of emissions in the event of equipment failure.

^bActual efficiency of a closed-vent system depends on percentage of vapors collected and efficiency of control device to which the vapors are routed.

^cControl efficiency of closed vent-systems installed on a pressure relief device may be lower than other closed-vent systems, because they must be designed to handle both potentially large and small volumes of vapor.

system should be used. At the reservoir, the pumped fluid can vaporize (i.e., de-gas) and then be collected by a closed-vent system.

The actual emissions reduction achievable through use of dual mechanical seals depends on the frequency of seal failure. Failure of both the inner and outer seals could result in relatively large releases of the process fluid. Pressure monitoring of the barrier fluid may be used to detect failure of the seals, allowing for a quick response to a failure.

5.2.2.2 Sealless Pumps. When operating properly, a sealless pump will not leak because the process fluid cannot escape to the atmosphere. Sealless pumps are used primarily in processes where the pumped fluid is hazardous, highly toxic, or very expensive, and where every effort must be made to prevent all possible leakage of the fluid. Under proper operating conditions, the control efficiency of sealless pumps is essentially 100 percent; however, if a catastrophic failure of a sealless pump occurs, there is a potential for a large quantity of emissions.

5.2.3 Compressors

Emissions from compressors may be reduced by collecting and controlling the emissions from the seal or by improving seal performance. Shaft seals for compressors are of several different types--all of which restrict but do not eliminate leakage. In some cases, compressors can be equipped with ports in the seal area to evacuate collected gases using a closed-vent system. Additionally, for some compressor seal types, emissions can be controlled by using a barrier fluid in a similar manner as described for pumps.

5.2.4 Pressure Relief Valves

Equipment leaks from pressure relief valves (PRV's) occur as a result of improper reseating of the valve after a release, or if the process is operating too close to the set pressure of the PRV and the PRV does not maintain its seal. Emissions occurring from PRV's as a result of an overpressure discharge are not considered to be equipment leak emissions. There are two primary

alternatives for controlling equipment leaks from pressure relief devices: use of a rupture disk (RD) in conjunction with the PRV, or use of a closed-vent system.

5.2.4.1 Rupture Disk/Pressure Relief Valve Combination.

Although they are also pressure relief devices, RD's can be installed upstream of a PRV to prevent fugitive emissions through the PRV seat. Rupture disk/pressure relief valve combinations require certain design constraints and criteria to avoid potential safety hazards, which are not covered in this document. If the RD fails, it must be replaced. The control efficiency of the RD/PRV combination is assumed to be 100 percent when operated and maintained properly.

5.2.4.2 Closed-Vent System.

A closed-vent system can be used to transport equipment leaks from a pressure relief device to a control device such as a flare. The equipment leak control efficiency for a closed-vent system installed on a pressure relief device may not be as high as the control efficiency that can be achieved by installing a closed-vent system on other equipment types. This is because emissions from pressure relief devices can be either high flow emissions during an overpressure incident or low flow emissions associated with equipment leaks, and it may be difficult to design a control device to efficiently handle both high and low flow emissions.

5.2.5 Valves

Emissions from process valves can be eliminated if the valve stem can be isolated from the process fluid. Two types of sealless valves are available: diaphragm valves and sealed bellows valves. The control efficiency of both diaphragm and sealed bellows valves is virtually 100 percent. However, a failure of these types of valves has the potential to cause temporary emissions much larger than those from other types of valves.

5.2.6 Connectors

In cases where connectors are not required for safety, maintenance, process modification, or periodic equipment removal, emissions can be eliminated by welding the connectors together.

5.2.7 Open-Ended Lines

Emissions from open-ended lines can be controlled by properly installing a cap, plug, or second valve to the open end. If a second valve is installed, the upstream valve should always be closed first after use of the valves to prevent the trapping of fluids between the valves. The control efficiency of these measures is assumed to be essentially 100 percent.

5.2.8 Sampling Connections

Emissions from sampling connections occur as a result of purging the sampling line to obtain a representative sample of the process fluid. Emissions from sampling connections can be reduced by using a closed-loop sampling system or by collecting the purged process fluid and transferring it to a control device or back to the process. The closed-loop sampling system is designed to return the purged fluid to the process at a point of lower pressure. A throttle valve or other device is used to induce the pressure drop across the sample loop. The efficiency of a closed-loop system is assumed to be 100 percent.

Alternatively, in some cases, sampling connections can be designed to collect samples without purging the line. If such a sampling connection is installed and no emissions to the atmosphere occur when a sample is collected, then the control efficiency can be assumed to be 100 percent.

5.3 LEAK DETECTION AND REPAIR CONTROL EFFECTIVENESS

An LDAR program is designed to identify pieces of equipment that are emitting sufficient amounts of material to warrant reduction of the emissions through repair. These programs are best applied to equipment types that can be repaired on-line, resulting in immediate emissions reduction, and/or to equipment types for which equipment modifications are not feasible. An LDAR program is best suited to valves and pumps, and can also be implemented for connectors.

For other equipment types, an LDAR program is not as applicable. Compressors are repaired in a manner similar to pumps; however, because compressors ordinarily do not have a spare for bypass, a process unit shutdown may be required for

repair. Open-ended lines are most easily controlled by equipment modifications. Emissions from sampling connections can only be reduced by changing the method of collecting the sample (since by definition equipment leak emissions are the material purged from the line), and cannot be reduced by an LDAR program. Safety considerations may preclude the use of an LDAR program on pressure relief valves.

In this section, an approach is presented that can be used to estimate the control effectiveness of any given LDAR program for light liquid pumps, gas valves, light liquid valves, and connectors. The approach is based on the relationship between the percentage of equipment pieces that are leaking and the corresponding average leak rate for all of the equipment. In this approach, the three most important factors in determining the control effectiveness are: (1) how a "leak" is defined, (2) the initial leak frequency before the LDAR program is implemented, and (3) the final leak frequency after the LDAR program is implemented. The leak definition (or action level) is the screening value at which a "leak" is indicated if a piece of equipment screens equal to or greater than that value. The leak frequency is the fraction of equipment with screening values equal to or greater than the leak definition.

Once these three factors are determined, a graph that plots leak frequency versus mass emission rate at several different leak definitions is used to predict emissions preceding and subsequent to implementing the LDAR program. In this way the emissions reduction (i.e., control effectiveness) associated with the LDAR program can be easily calculated.

A general description of the approach is provided in the subsections below. This is followed by an example application of the approach. The approach has been applied to determine the control effectiveness at Synthetic Organic Chemical Manufacturing Industry (SOCMI) and refinery process units for the following LDAR programs: (1) monthly LDAR with a leak definition of 10,000 parts per million by volume (ppmv), (2) quarterly LDAR with a leak definition of 10,000 ppmv, and (3) LDAR equivalent to that

specified in the proposed hazardous organic National Emission Standard for Hazardous Air Pollutants (NESHAP) equipment leaks negotiated regulation.¹ Tables 5-2 and 5-3 summarize the estimated control effectiveness for the three LDAR programs mentioned above at SOCFI process units and refineries, respectively. It should be noted that, to calculate the control effectiveness values presented in tables 5-2 and 5-3, assumptions were made that may not necessarily be applicable to specific process units. For example, the control effectiveness values in the tables are based on the assumption that the emission rate prior to implementing the LDAR program is the emission rate that would be predicted by the average emission factor. The best way to calculate the effectiveness of an LDAR program is by collecting and analyzing data at the specific process unit.

5.3.1 Approach for Estimating LDAR Control Effectiveness

As previously stated, the key parameters for estimating the control effectiveness of an LDAR program are the leak definition, the initial leak frequency, and the final leak frequency. The leak definition is a given part of an LDAR program. It can either be defined by the process unit implementing the program or by an equipment standard to which the process unit must comply. After the leak definition is established, the control effectiveness of an LDAR program can be estimated based on the average leak rate before the LDAR program is implemented, and the average leak rate after the program is in place.

Figures 5-1 through 5-4 are graphs presenting mass emission rate versus leak frequency for SOCFI-type process units at several leak definitions for gas valves, light liquid valves, light liquid pumps, and connectors, respectively. Figures 5-5 through 5-8 are graphs presenting mass emission rate versus leak frequency for refinery process units at several leak definitions for gas valves, light liquid valves, light liquid pumps, and connectors, respectively. Figures 5-9 through 5-15 are graphs presenting mass emission rate versus leak frequency for gas fittings, light liquid fittings, gas others, light liquid others, light liquid pumps, gas valves, and light liquid valves, for

TABLE 5-2. CONTROL EFFECTIVENESS FOR AN LDAR PROGRAM AT A SOCMI PROCESS UNIT

Equipment type and service	Control effectiveness (%)		
	Monthly monitoring 10,000 ppmv leak definition	Quarterly monitoring 10,000 ppmv leak definition	HON reg neg ^a
Valves - gas	87	67	92
Valves - light liquid	84	61	88
Pumps - light liquid	69	45	75
Connectors - all	b	b	93

^a Control effectiveness attributable to the requirements of the proposed hazardous organic NESHAP equipment leak negotiated regulation are estimated based on equipment-specific leak definitions and performance levels.

^b Data are not available to estimate control effectiveness.

TABLE 5-3. CONTROL EFFECTIVENESS FOR AN LDAR PROGRAM AT A REFINERY PROCESS UNIT

Equipment type and service	Control effectiveness (%)		
	Monthly monitoring 10,000 ppmv leak definition	Quarterly monitoring 10,000 ppmv leak definition	HON reg neg ^a
Valves - gas	88	70	96
Valves - light liquid	76	61	95
Pumps - light liquid	68	45	88
Connectors - all	b	b	81

^a Control effectiveness attributable to the requirements of the proposed hazardous organic NESHAP equipment leak negotiated regulation are estimated based on equipment-specific leak definitions and performance levels.

^b Data are not available to estimate control effectiveness.

SOCMI Gas Valve Equations

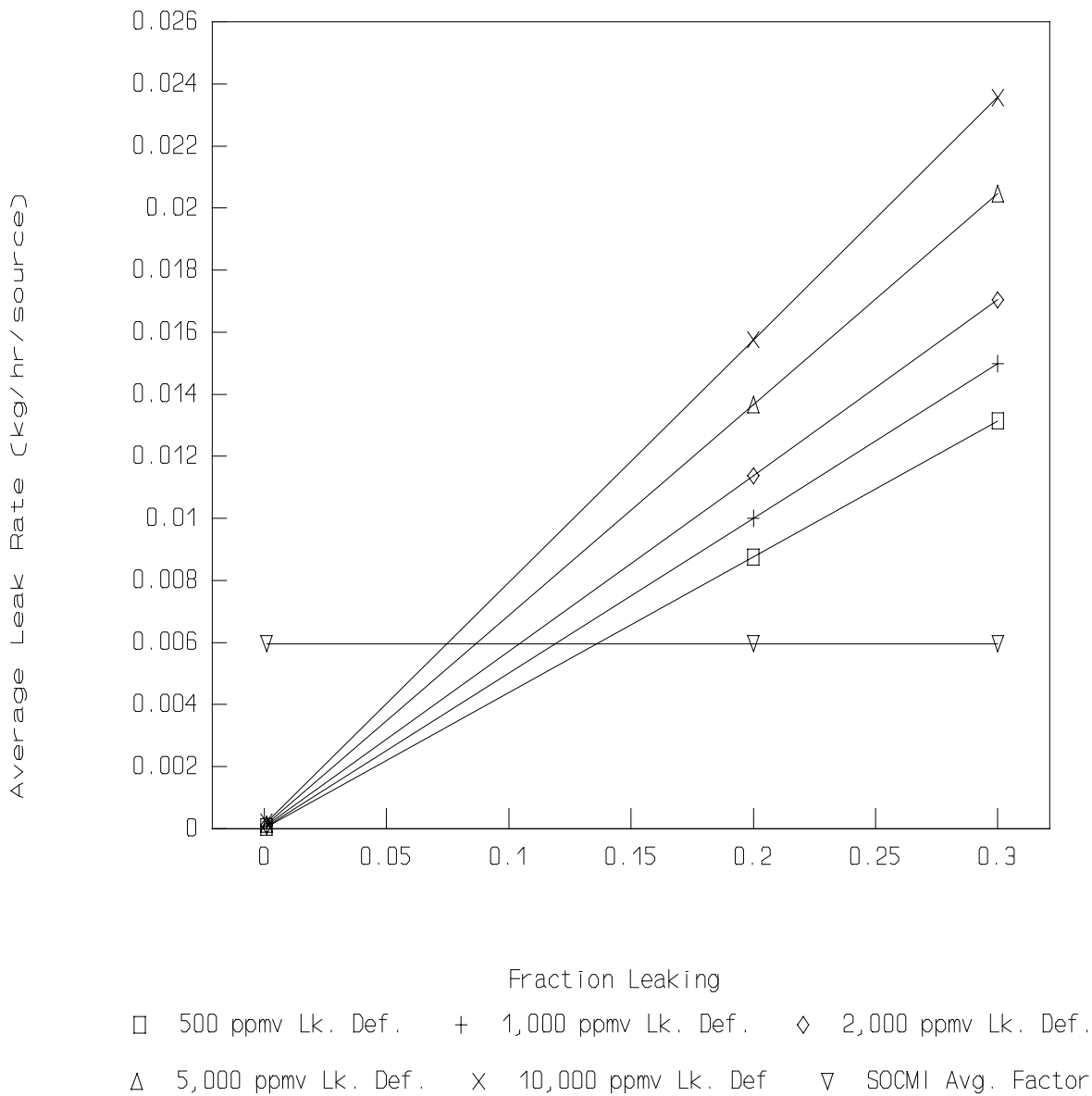

Figure 5-1. SOCMI Gas Valve Average Leak Rate Versus Fraction Leaking at Several Leak Definitions.

SOCMI Light Liquid Valve Equations

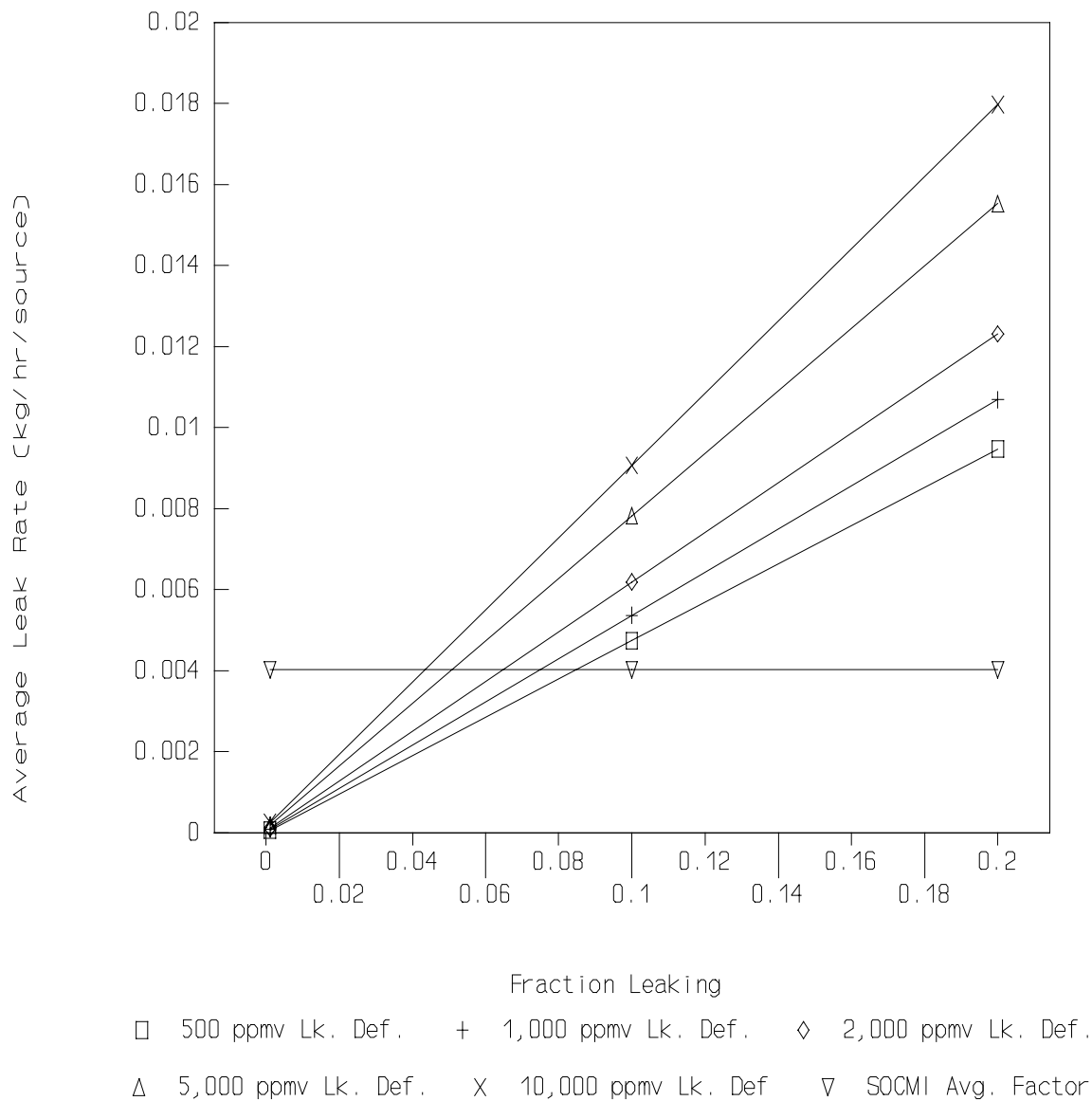
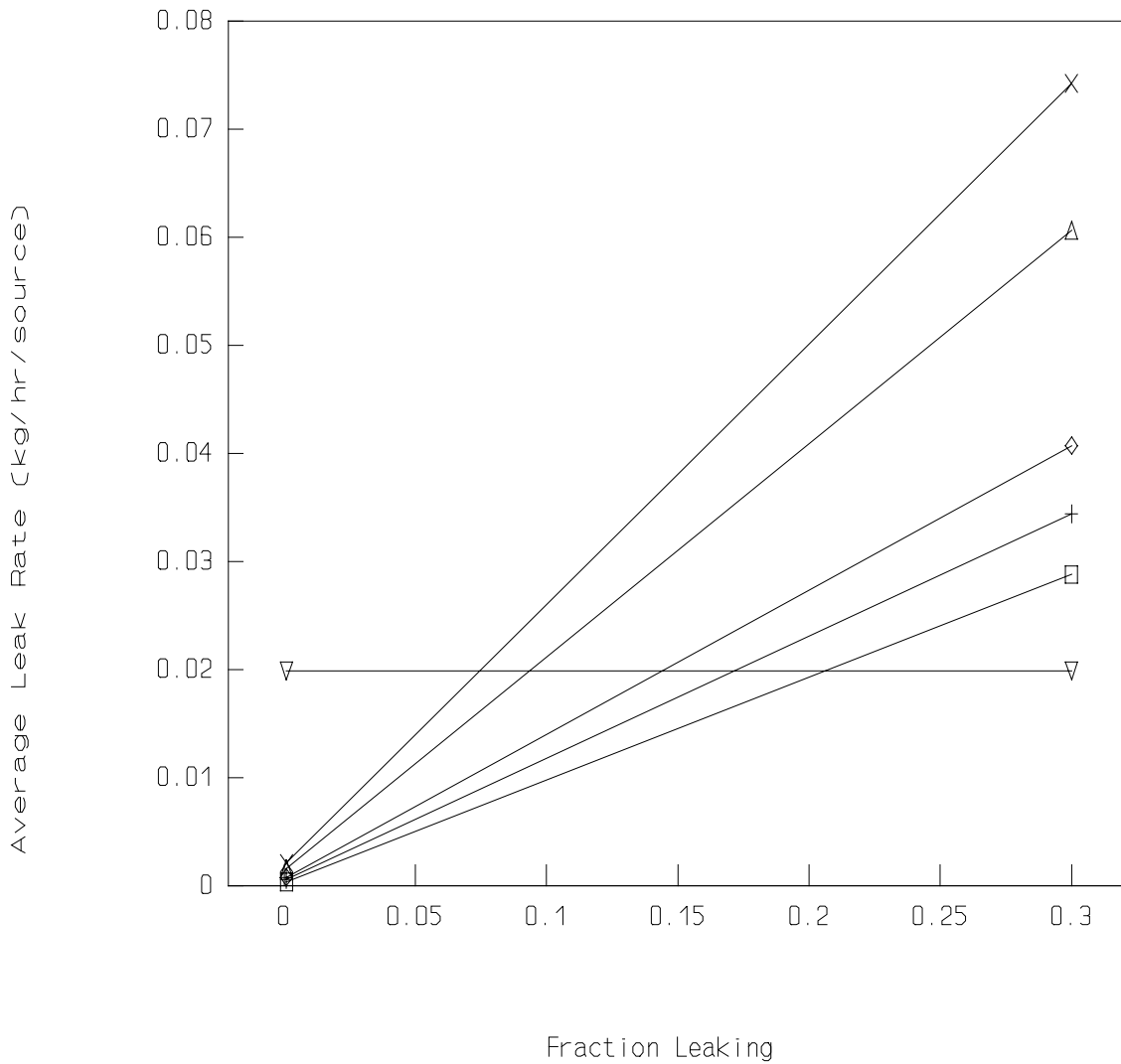

Figure 5-2. SOCMI Light Liquid Valve Average Mass Emission Rate Versus Fraction Leaking at Several Leak Definitions

SOCMI Light Liquid Pump Equations



□ 500 ppmv Lk. Def. + 1,000 ppmv Lk. Def. ◇ 2,000 ppmv Lk. Def.
 Δ 5,000 ppmv Lk. Def. X 10,000 ppmv Lk. Def. ▽ SOCMI Avg. Factor

Figure 5-3. SOCMI Light Liquid Pump Average Leak Rate Versus Fraction Leaking at Several Leak Definitions

SOCMI Connector Equations

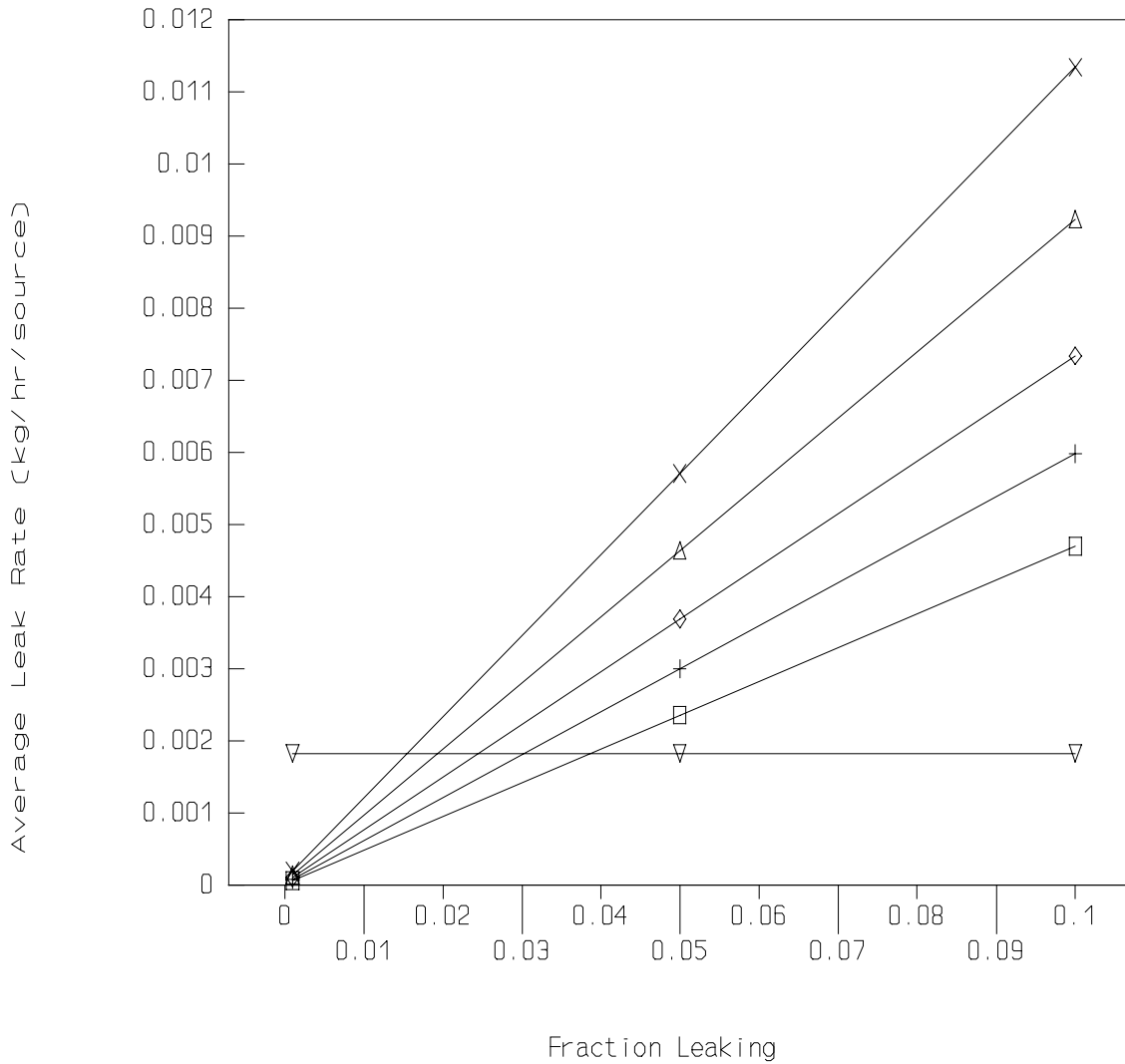

□ 500 ppmv Lk. Def. + 1,000 ppmv Lk. Def. ◇ 2,000 ppmv Lk. Def.
 Δ 5,000 ppmv Lk. Def. X 10,000 ppmv Lk. Def. ∇ SOCMI Avg. Factor

Figure 5-4. SOCMI Connector Average Leak Rate Versus Fraction Leaking at Several Leak Definitions.

Refinery Gas Valve Equations

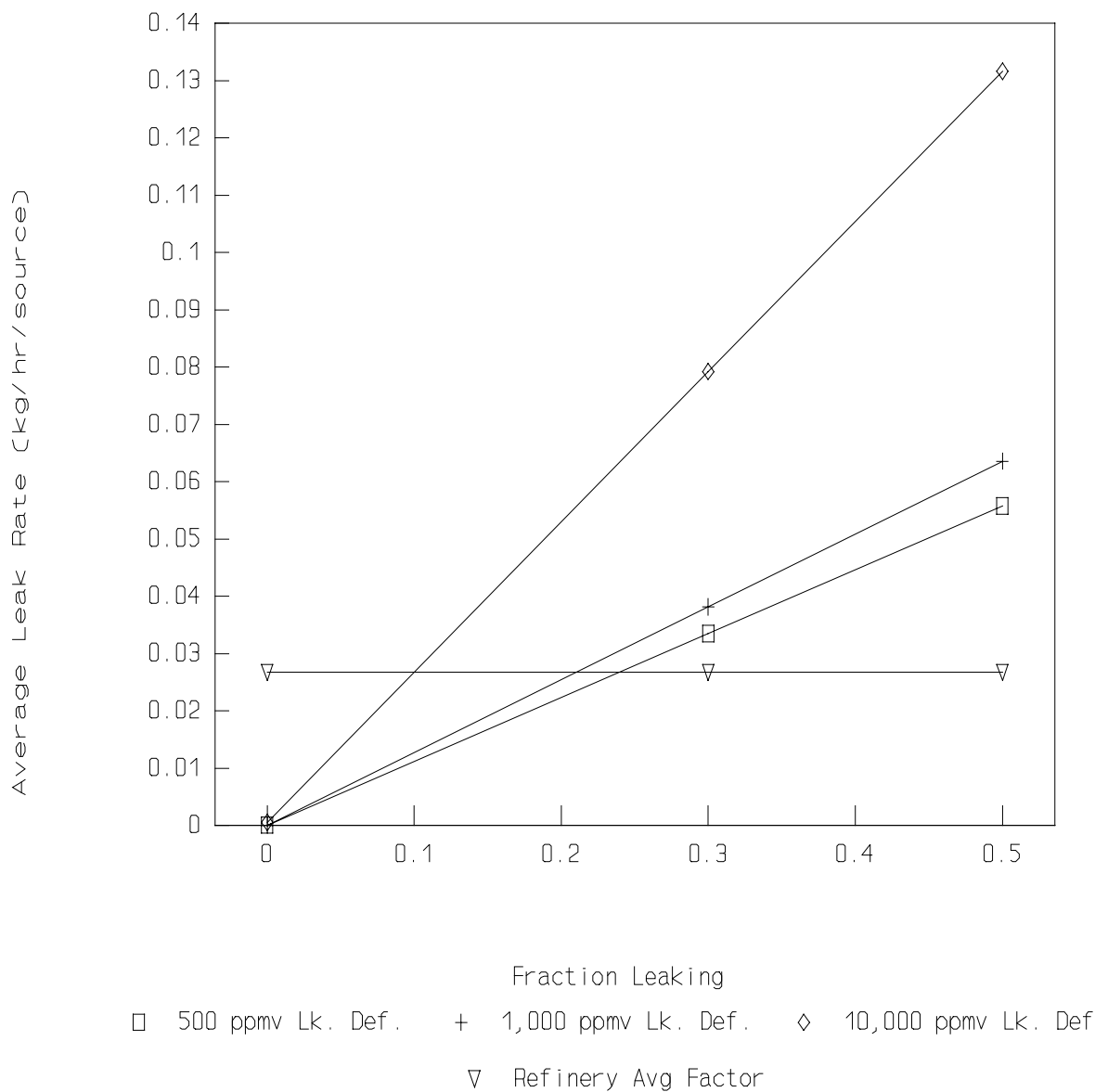

Figure 5-5. Refinery Gas Valve Average Leak Rate Versus Fraction Leaking at Several Leak Definitions

Refinery Light Liquid Valve Equations

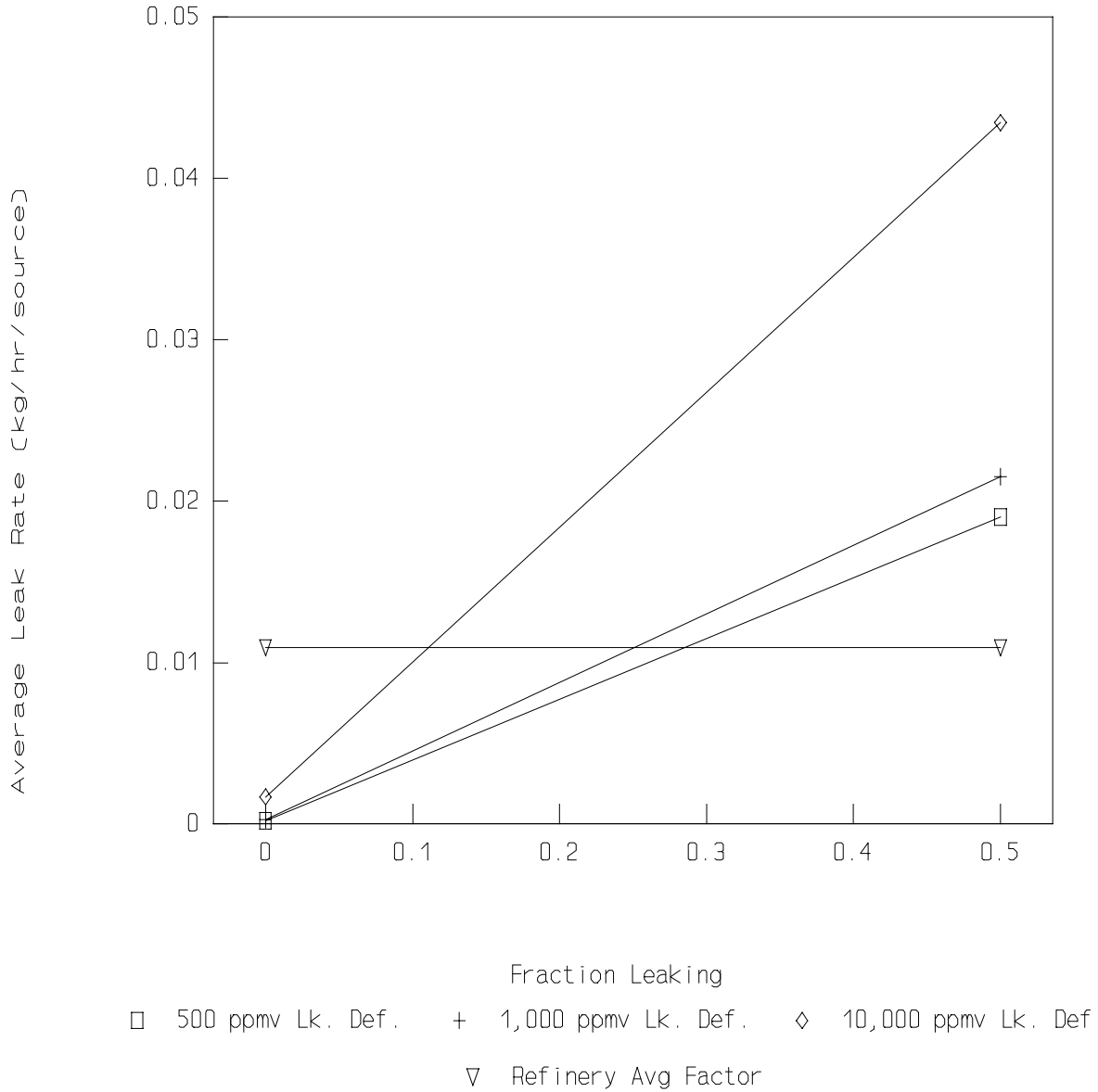

Figure 5-6. Refinery Light Liquid Valve Average Leak Rate Versus Fraction Leaking at Several Leak Definitions

Refinery Light Liquid Pump Equations

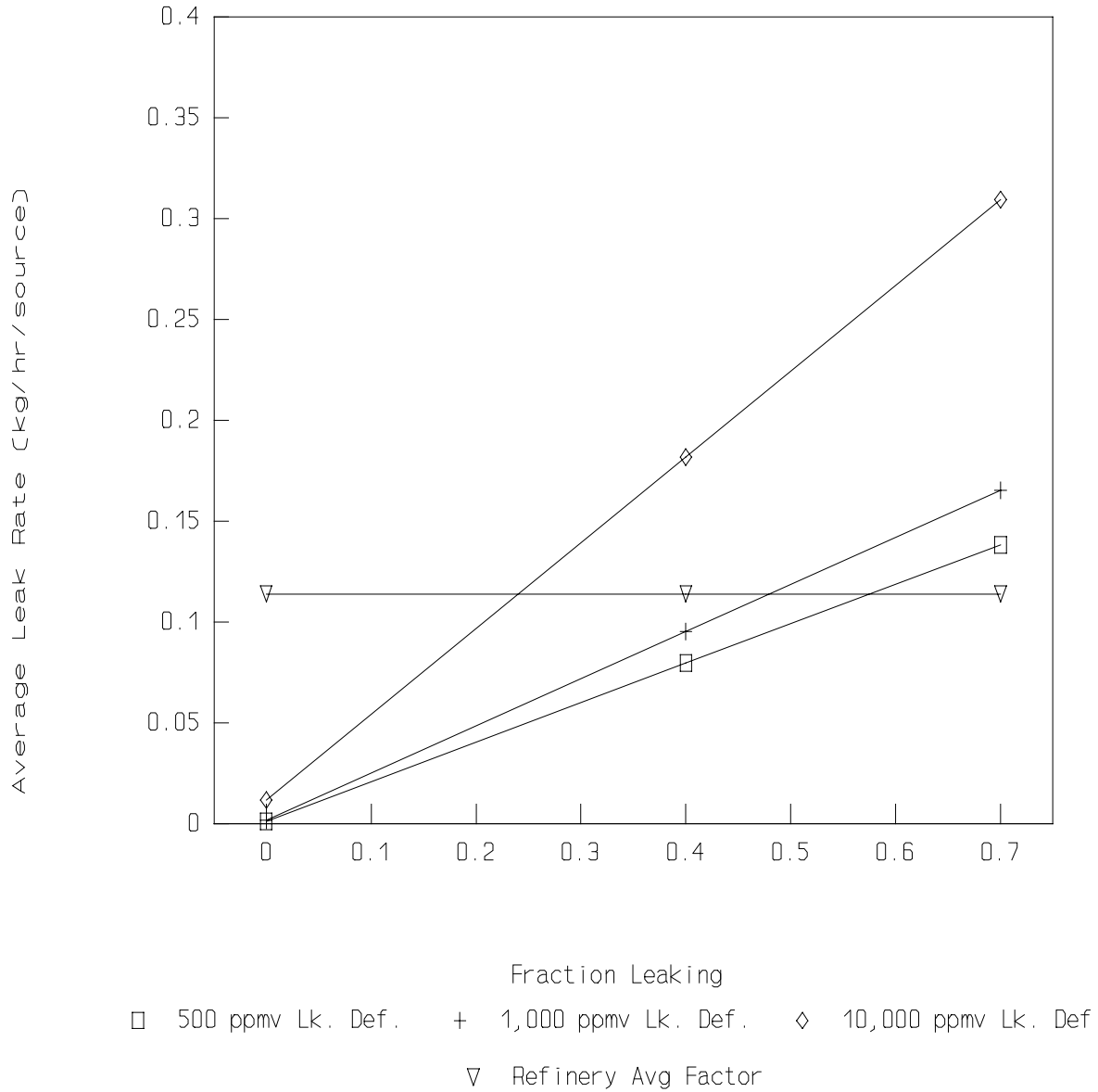

Figure 5-7. Refinery Light Liquid Pump Average Leak Rate Versus Fraction Leaking at Several Leak Definitions

Refinery Connector Equations

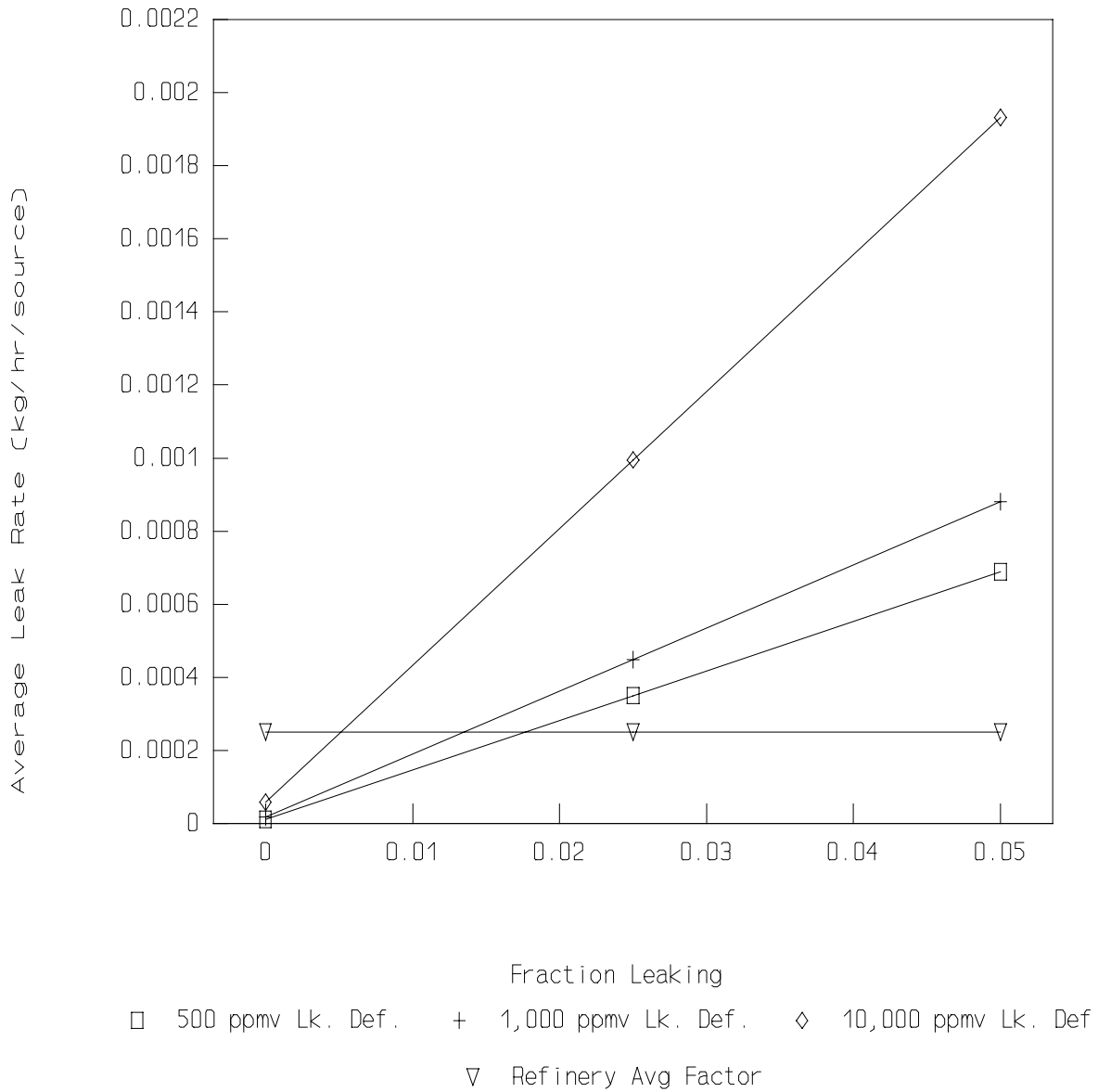
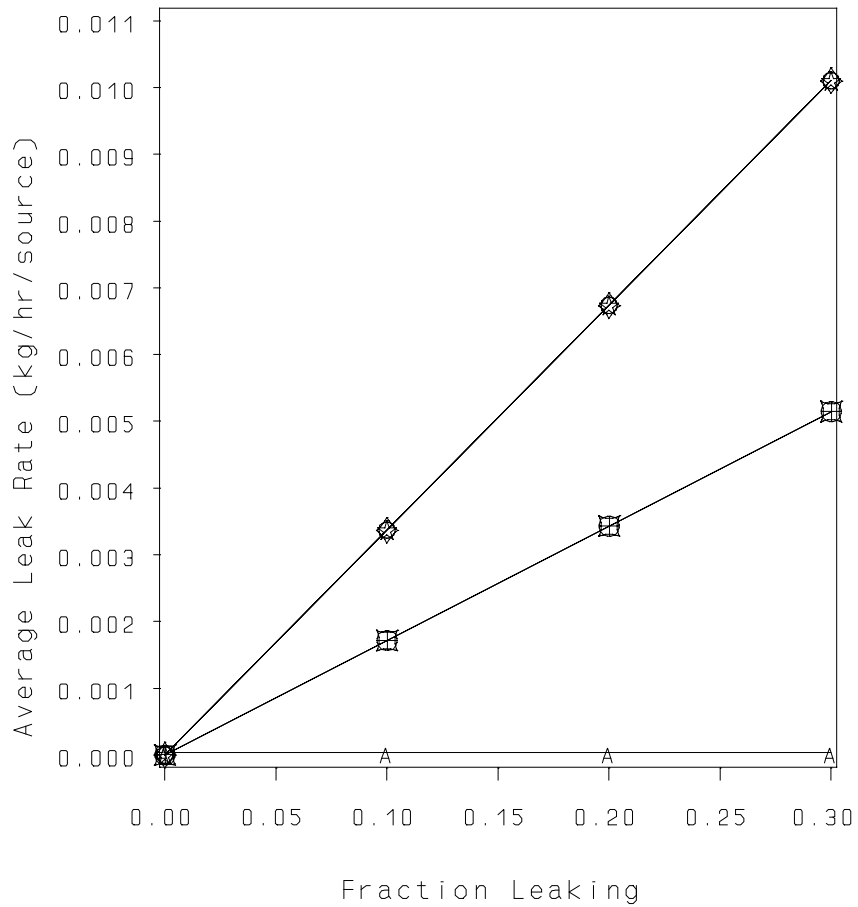

Figure 5-8. Refinery Connector Average Leak Rate Versus Fraction Leaking at Several Leak Definitions

Average Leak Rate Curves Marketing Terminals – Gas Fittings



Leak Definition:

- | | |
|-----------------|------------------|
| ⊕⊕⊕ 500 ppmv | ⊞⊞⊞ 1,000 ppmv |
| ◇◇◇ 2,000 ppmv | ⊖⊖⊖ 5,000 ppmv |
| ☆☆☆ 10,000 ppmv | A-A-A Avg Factor |

Figure 5-9. Marketing Terminal Gas Fittings Average Leak Rate Versus Fraction Leaking at Several Leak Definitions

Average Leak Rate Curves

Marketing Terminals – Light Liquid Fittings

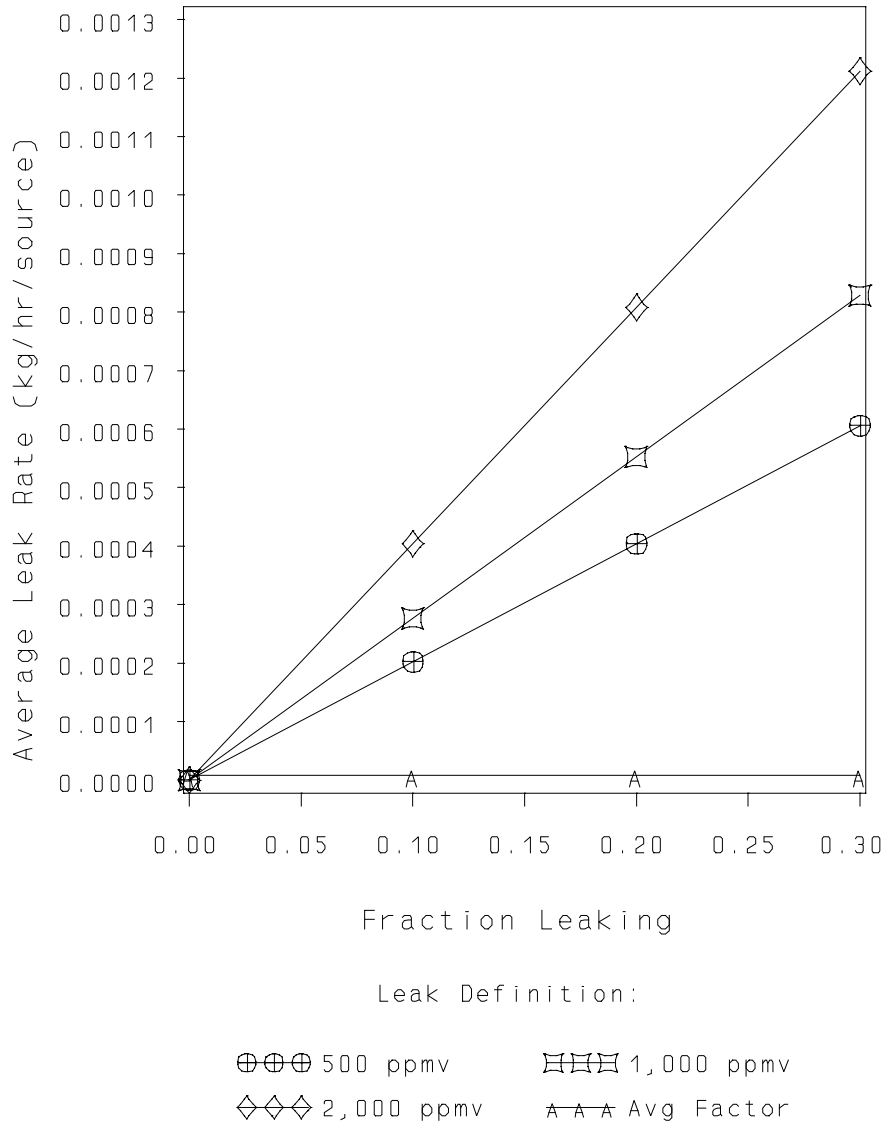

Figure 5-10. Marketing Terminal Light Liquid Fittings Average Leak Rate Versus Fraction Leaking at Several Leak Definitions

Average Leak Rate Curves Marketing Terminals – Gas Others

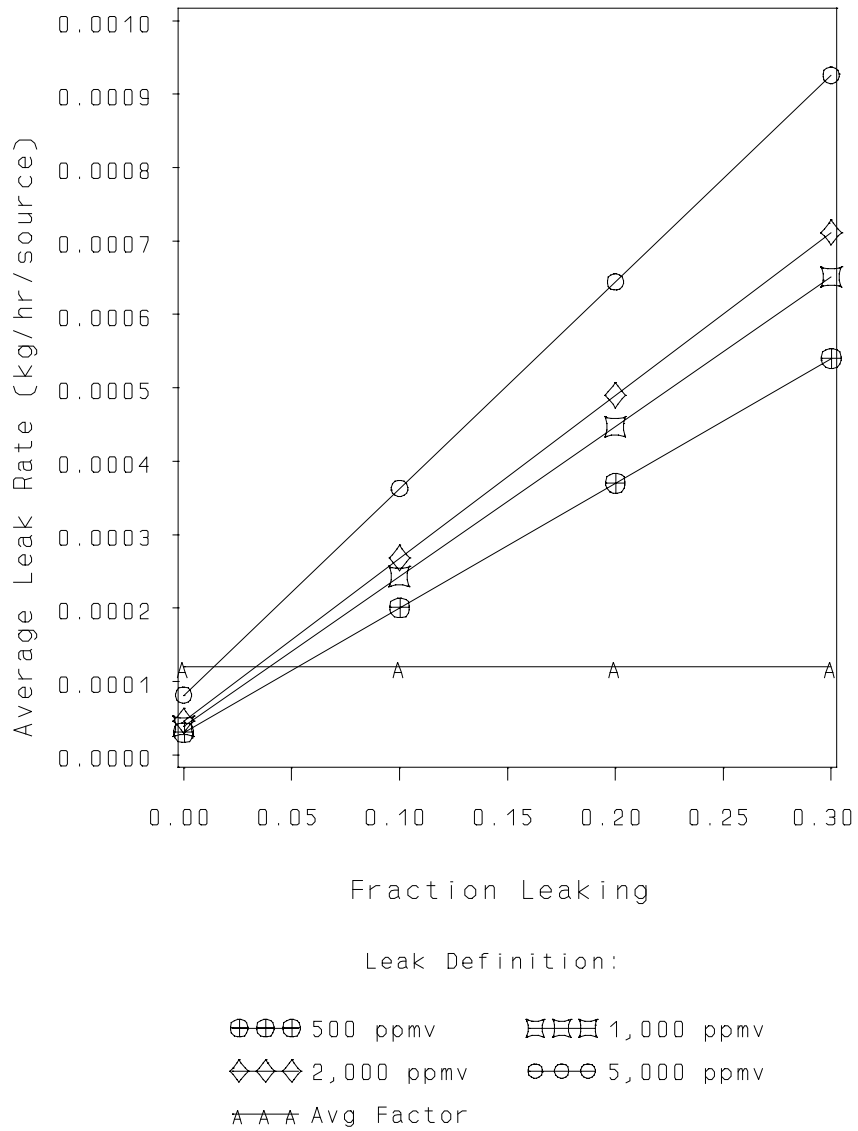
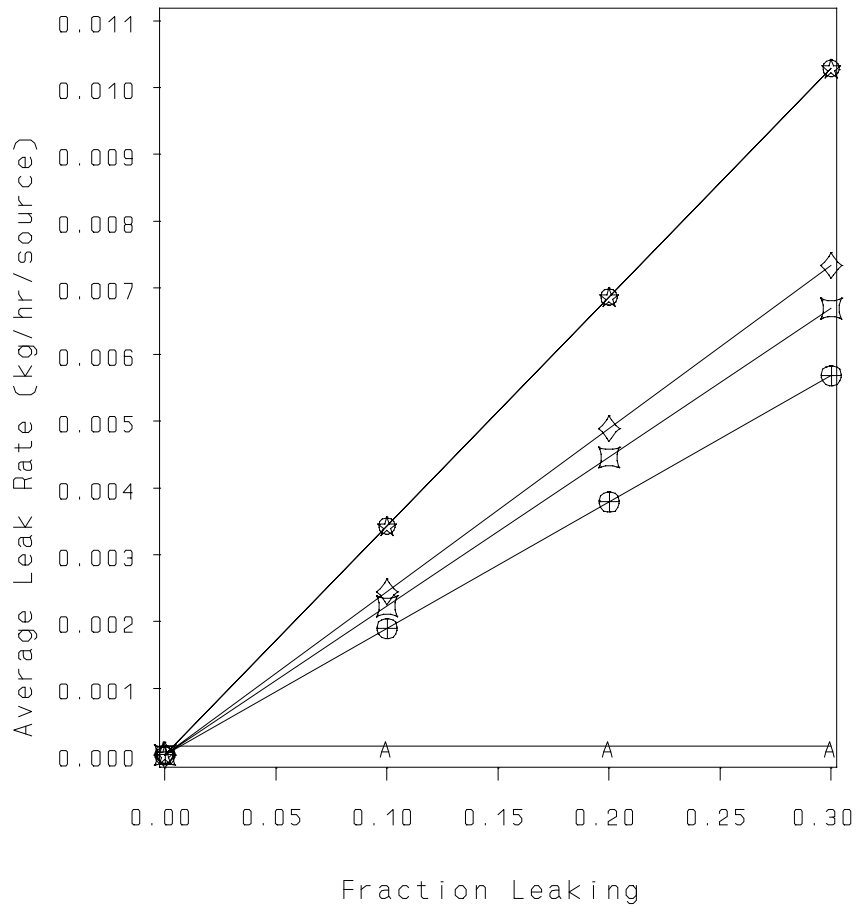

Figure 5-11. Marketing Terminal Gas Others Average Leak Rate Versus Fraction Leaking at Several Leak Definitions

Average Leak Rate Curves Marketing Terminals – Light Liquid Others



Leak Definition:

- | | |
|-----------------|----------------|
| ⊕⊕⊕ 500 ppmv | ⊞⊞⊞ 1,000 ppmv |
| ◇◇◇ 2,000 ppmv | ⊖⊖⊖ 5,000 ppmv |
| ☆☆☆ 10,000 ppmv | ▲▲▲ Avg Factor |

Figure 5-12. Marketing Terminal Light Liquid Others Average Leak Rate Versus Fraction Leaking at Several Leak Definitions

Average Leak Rate Curves

Marketing Terminals – Light Liquid Pumps

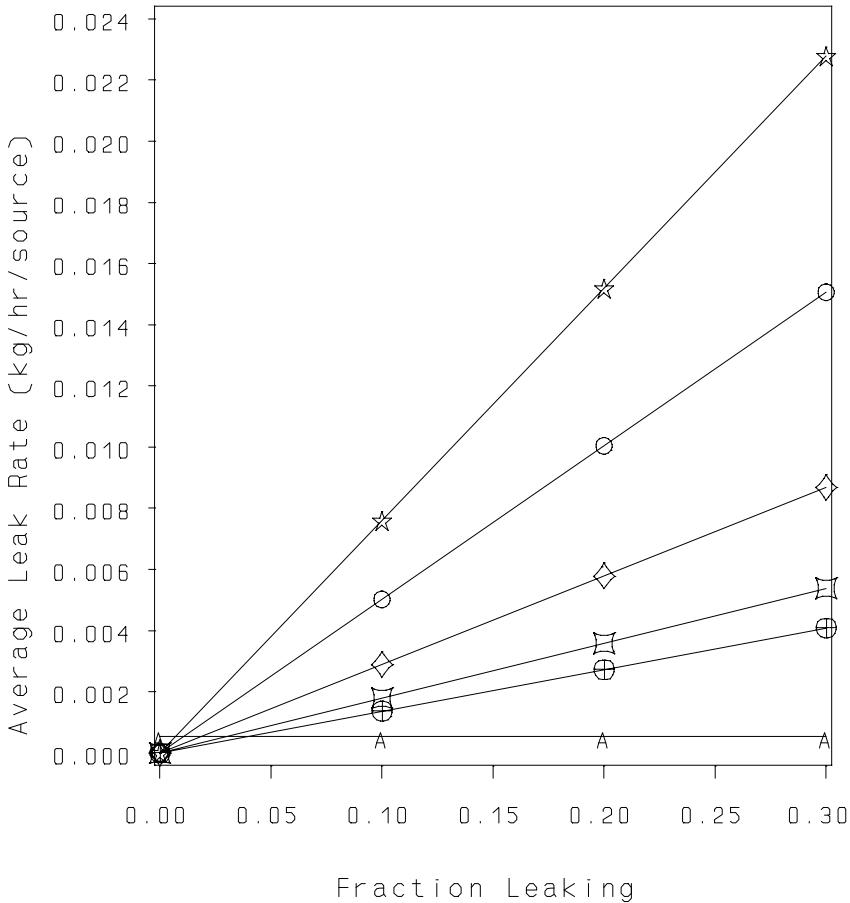

Leak Definition:

- ⊕⊕⊕ 500 ppmv ⊞⊞⊞ 1,000 ppmv
- ◇◇◇ 2,000 ppmv ⊖⊖⊖ 5,000 ppmv
- ☆☆☆ 10,000 ppmv A-A-A Avg Factor

Figure 5-13. Marketing Terminal Light Liquid Pumps Average Leak Rate Versus Fraction Leaking at Several Leak Definitions

Average Leak Rate Curves Marketing Terminals – Gas Valves

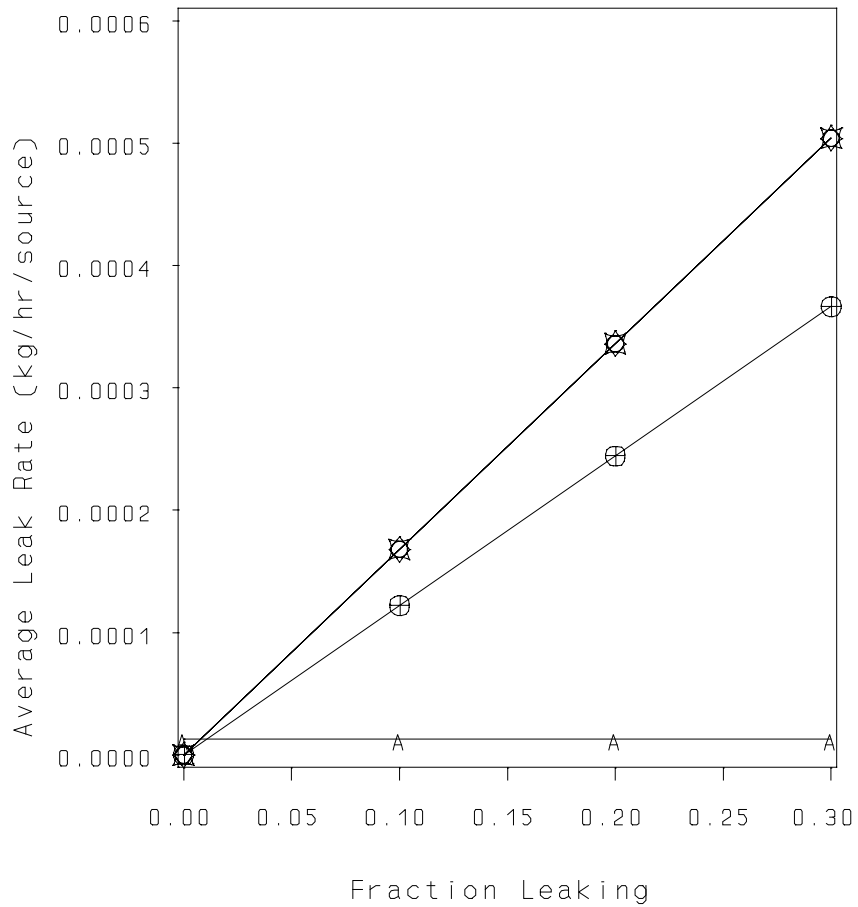

Leak Definition:

- ⊕⊕⊕ 500 ppmv ⊠⊠⊠ 1,000 ppmv
- ◇◇◇ 2,000 ppmv ⊙⊙⊙ 5,000 ppmv
- ▲▲▲ Avg Factor

Figure 5-14. Marketing Terminal Gas Valves Average Leak Rate Versus Fraction Leaking at Several Leak Definitions

Average Leak Rate Curves

Marketing Terminals – Light Liquid Valves

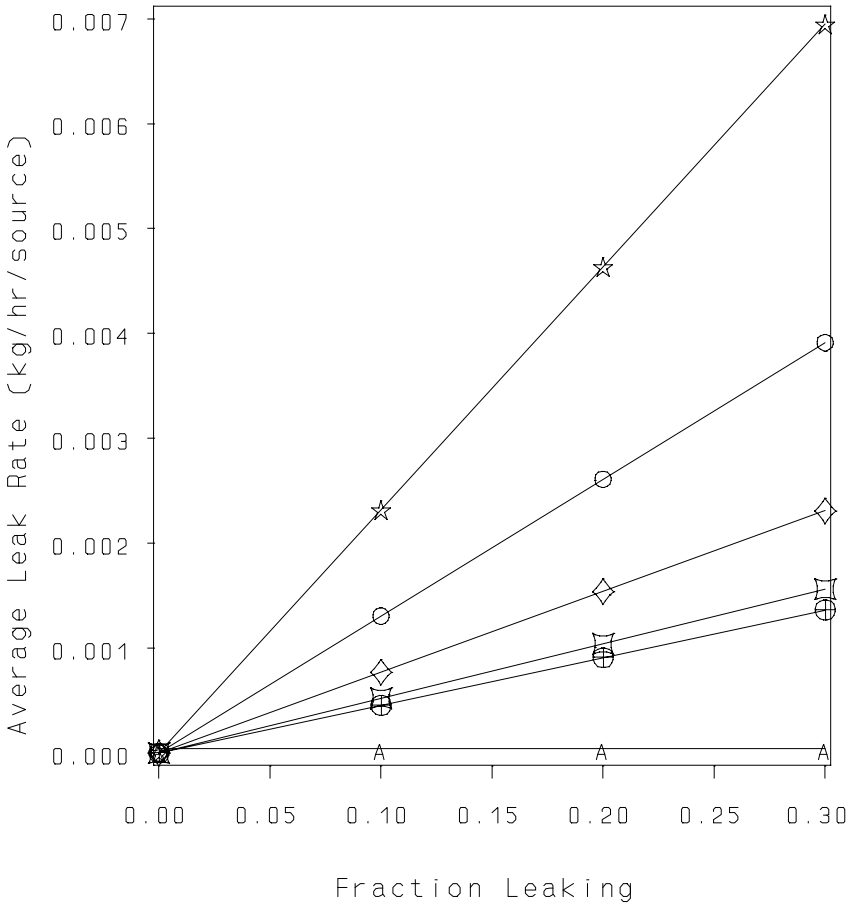

Leak Definition:

- ⊕⊕⊕ 500 ppmv ⊞⊞⊞ 1,000 ppmv
- ◇◇◇ 2,000 ppmv ⊖⊖⊖ 5,000 ppmv
- ☆☆☆ 10,000 ppmv ▲▲▲ Avg Factor

Figure 5-15. Marketing Terminal Liquid Light Valves Average Leak Rate Versus Fraction Leaking at Several Leak Definitions

marketing terminal process units. Figures 5-16 through 5-34 present mass emission rate as a function of leak frequency for connectors, flanges, open-ended lines, others, pumps, and valves at oil and gas production operations. Using these figures, for a given leak definition, the leak rate before and after the LDAR program is implemented, along with the corresponding control effectiveness, can be determined by plotting the initial and final leak frequency on these graphs. Tables 5-4, 5-5, 5-6, and 5-7 present equations for the lines in each of the SOCFI, refinery, marketing terminal, and oil and gas production operations, and graphs, respectively. Appendix G describes the approach that was used to develop the equations.

Figure 5-35 provides guidance on how to determine the initial and final leak frequencies. This figure is a simplified graphical presentation on how the leak frequency will change after an LDAR program is implemented. When generating the figure, it was assumed that all equipment pieces are monitored at the same time. Each occurrence of equipment monitoring is referred to as a "monitoring cycle," and it is assumed that equal time periods lapse between monitoring cycles.

From figure 5-35, it can be seen that there is an immediate reduction in leak frequency after the LDAR program is implemented, and then the leak frequency will oscillate over monitoring cycles. This oscillation occurs because between monitoring cycles a certain percentage of previously non-leaking equipment will begin to leak. There are four key points on the graph presented in figure 5-35. These key points are:

- Point X - initial leak frequency;
- Point Y - leak frequency immediately after monitoring for and repairing leaking equipment (i.e., immediately after a monitoring cycle);
- Point Z - leak frequency immediately preceding a monitoring cycle; and
- Point F - average leak frequency between monitoring cycles (final leak frequency).

Average Leak Rate Curves Oil & Gas Production – Gas Connectors

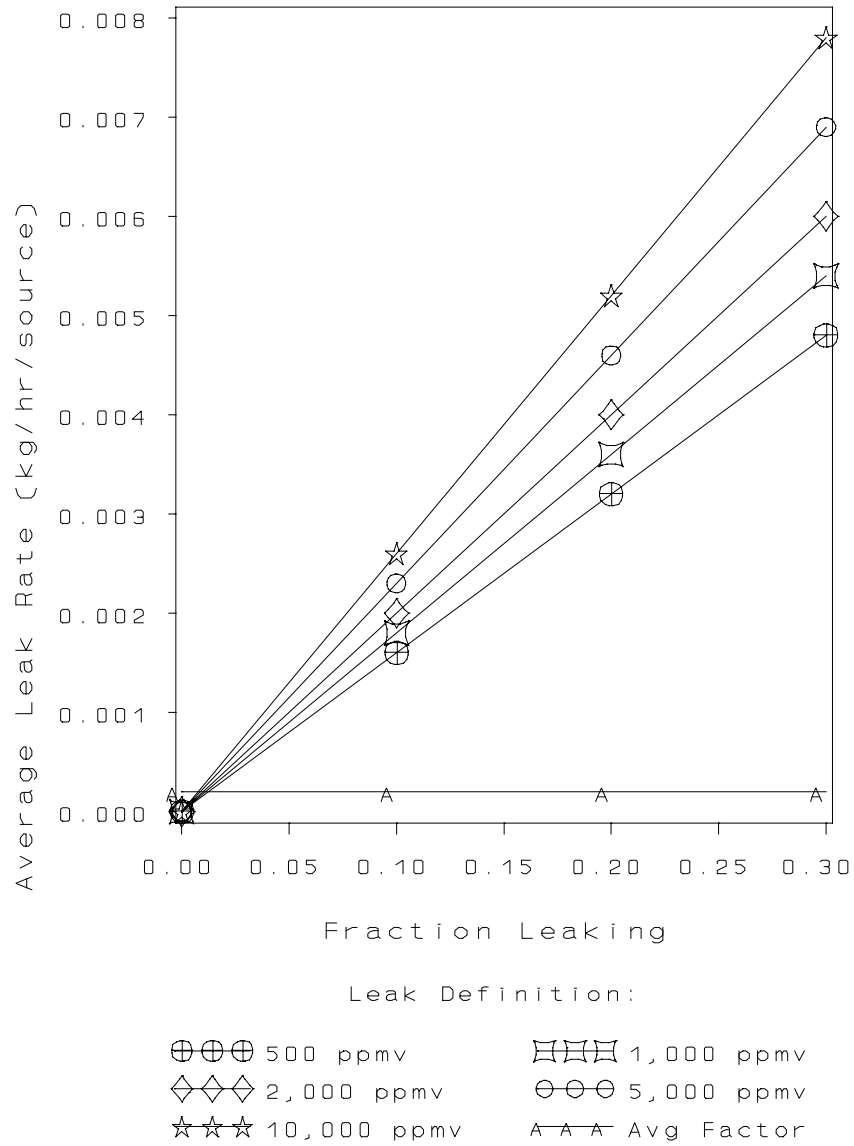

Figure 5-16. Oil and Gas Production Gas Connectors Average Leak Rate Versus Fraction Leaking at Several Leak Definitions

Average Leak Rate Curves Oil & Gas Production – Light Oil Connectors

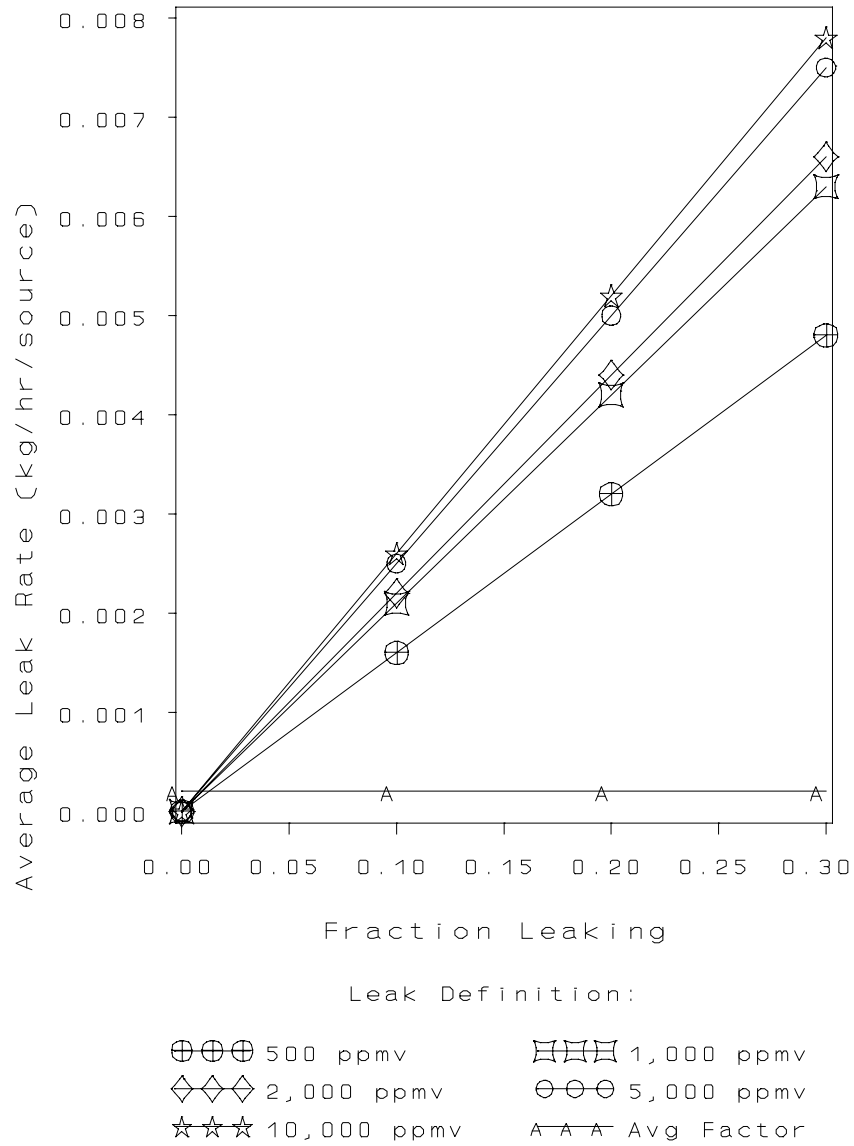

Figure 5-17. Oil and Gas Production Light Oil Connectors Average Leak Rate Versus Fraction Leaking at Several Leak Definitions

Average Leak Rate Curves Oil & Gas Production – Water/Oil Connectors

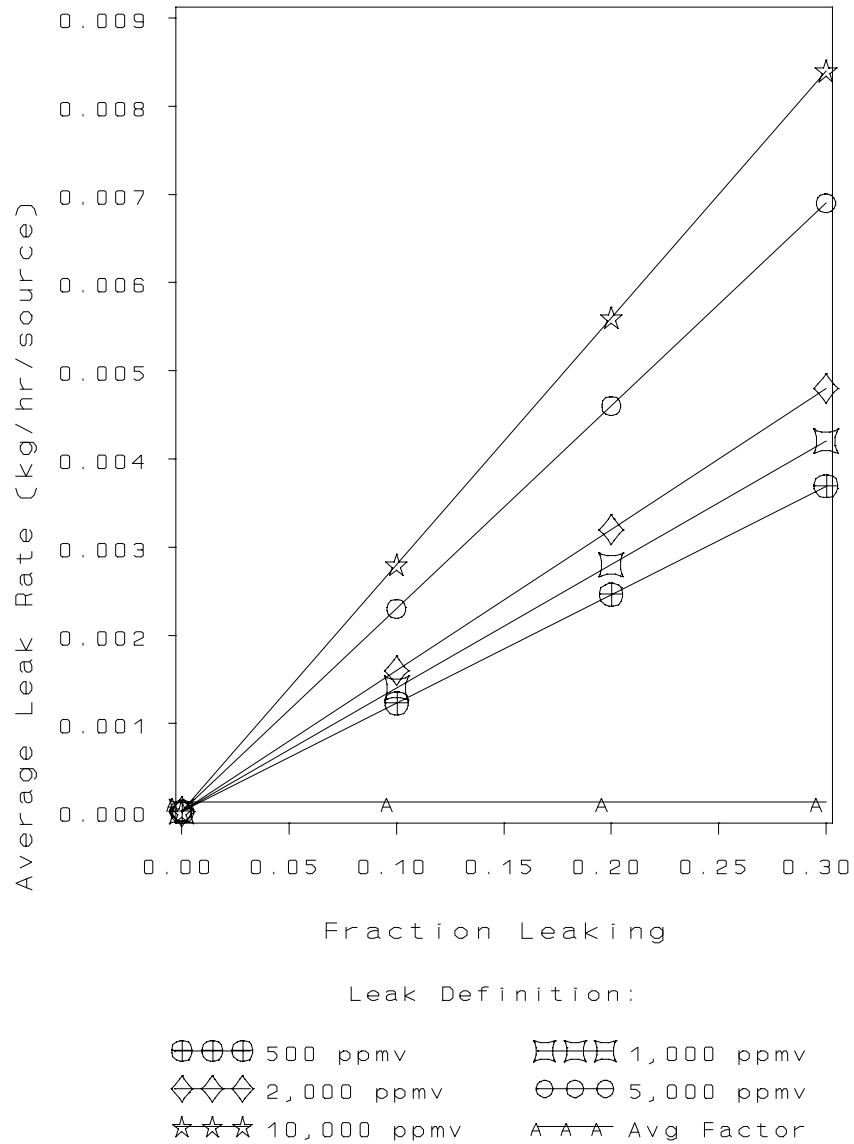

Figure 5-18. Oil and Gas Production Water/Oil Connectors Average Leak Rate Versus Fraction Leaking at Several Leak Definitions

Average Leak Rate Curves Oil & Gas Production – Gas Flanges

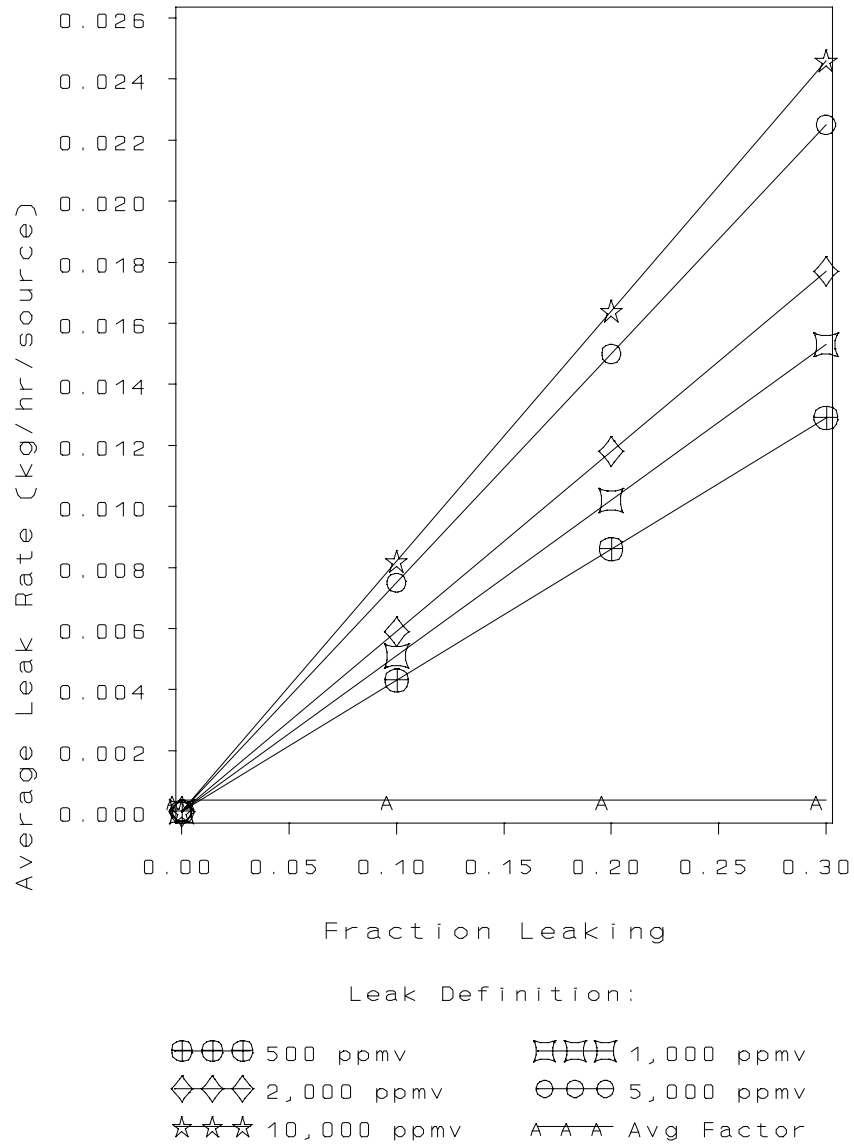

Figure 5-19. Oil and Gas Production Gas Flanges Average Leak Rate Versus Fraction Leaking at Several Leak Definitions

Average Leak Rate Curves Oil & Gas Production – Light Oil Flanges

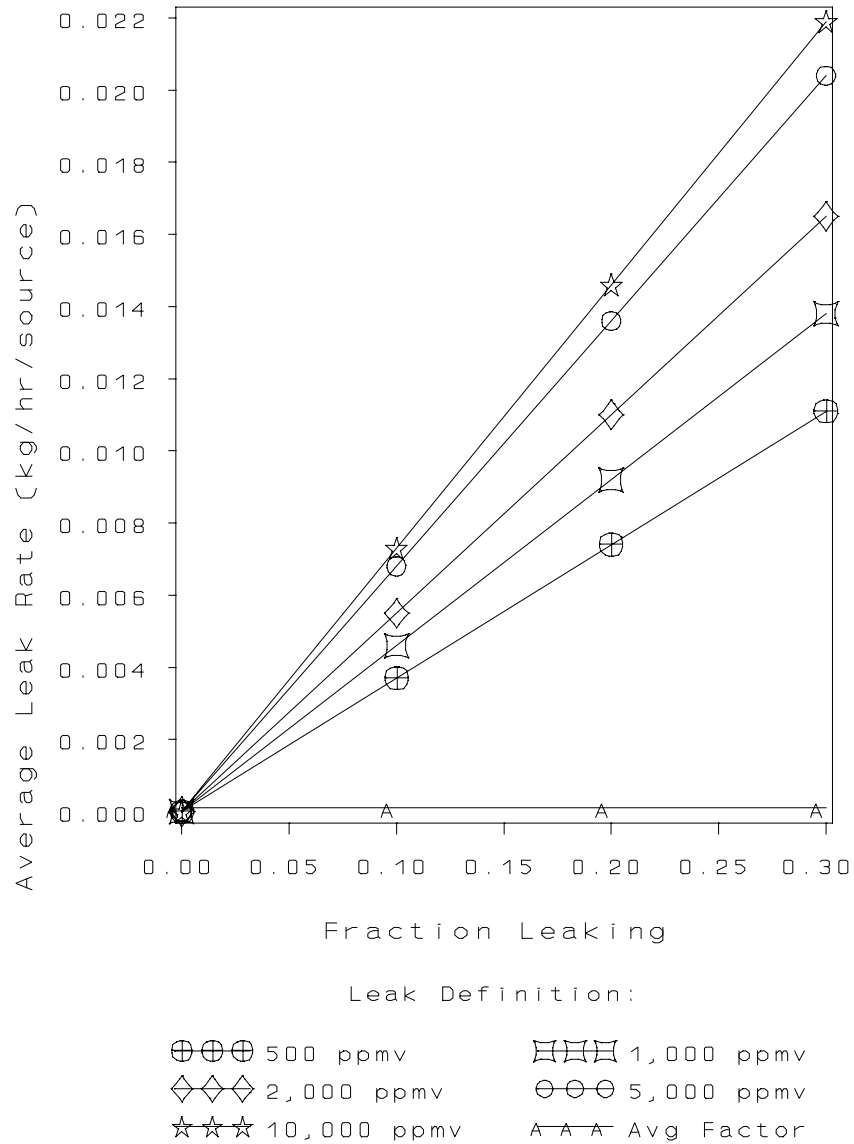

Figure 5-20. Oil and Gas Production Light Oil Flanges Average Leak Rate Versus Fraction Leaking at Several Leak Definitions

Average Leak Rate Curves

Oil & Gas Production – Gas Open-Ended Lines

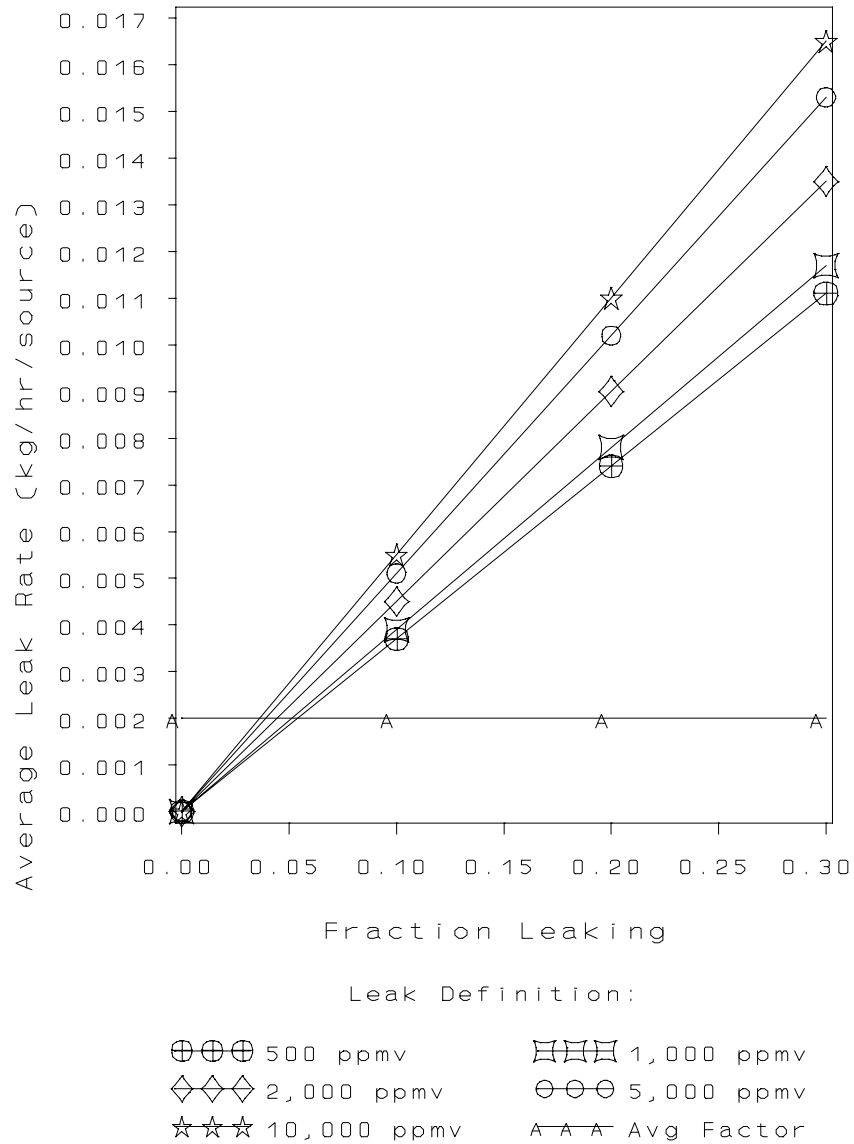

Figure 5-21. Oil and Gas Production Gas Open-Ended Lines Average Leak Rate Versus Fraction Leaking at Several Leak Definitions

Average Leak Rate Curves

Oil & Gas Production – Heavy Oil Open-Ended Lines

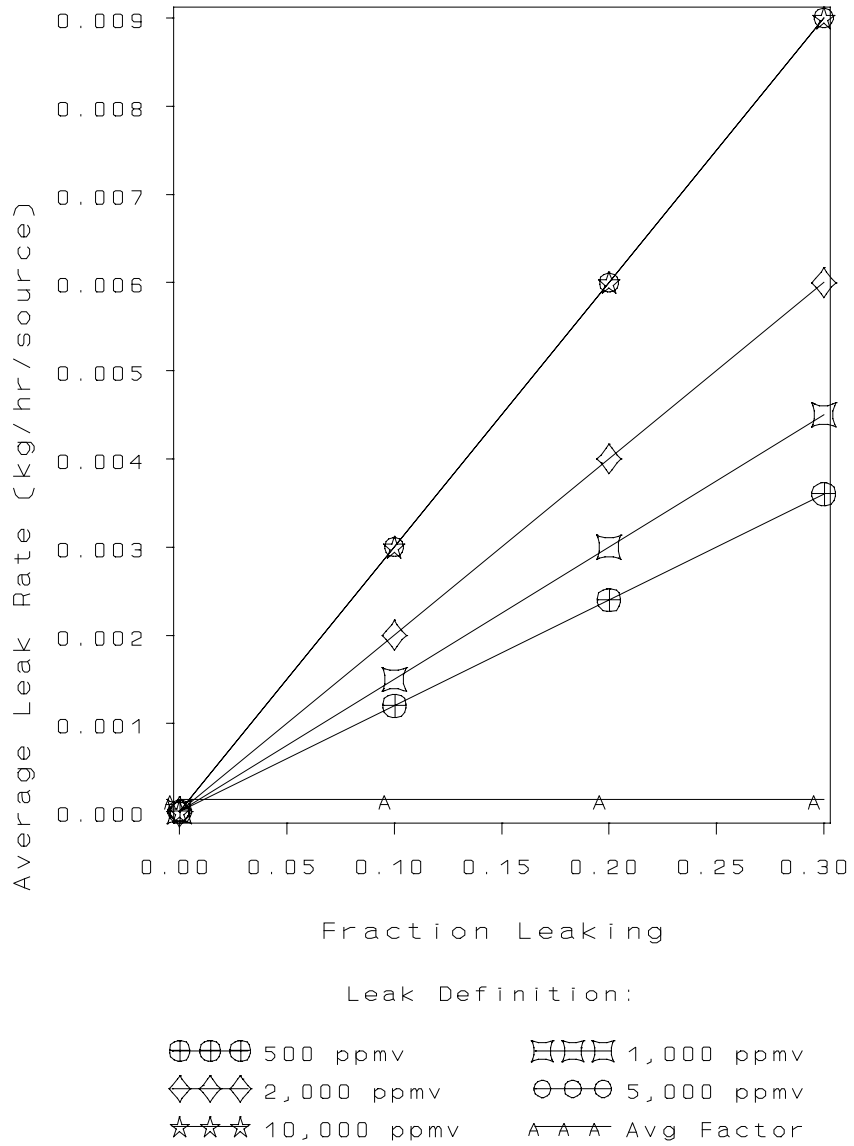

Figure 5-22. Oil and Gas Production Heavy Oil Open-Ended Lines Average Leak Rate Versus Fraction Leaking at Several Leak Definitions

Average Leak Rate Curves

Oil & Gas Production – Light Oil Open-Ended Lines

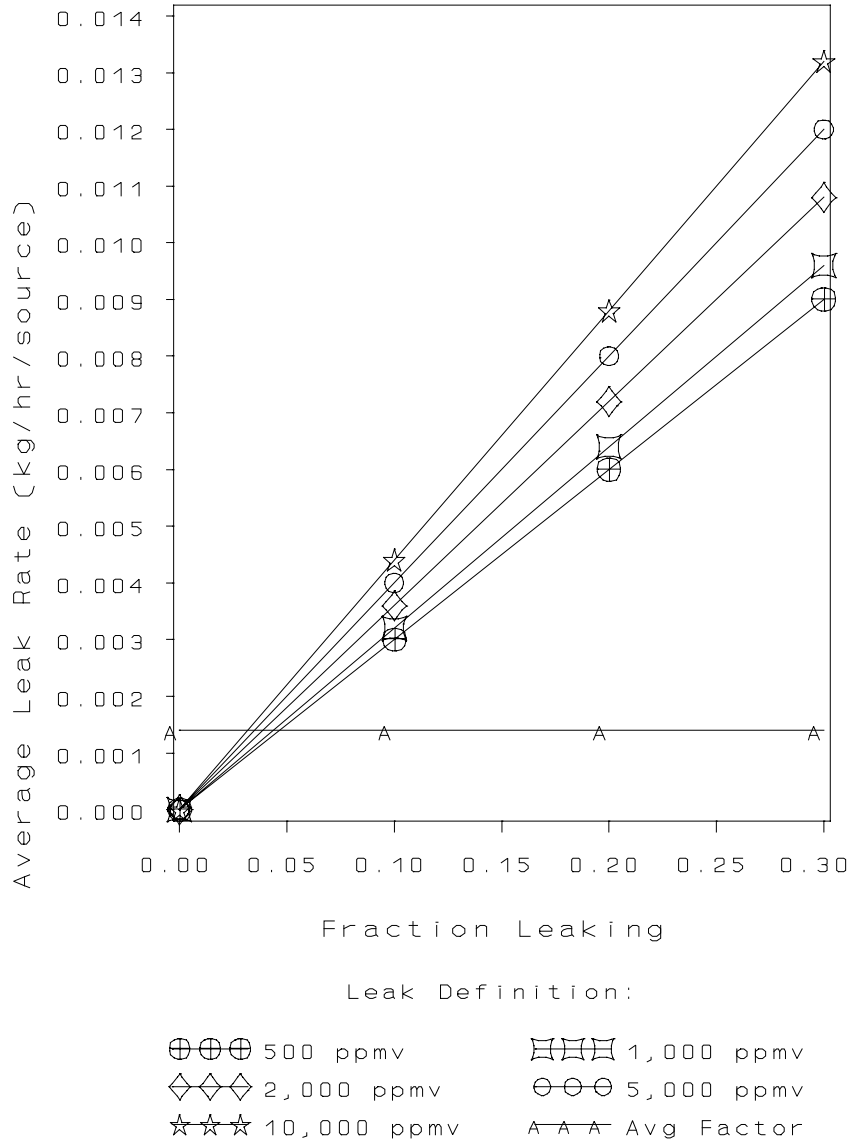
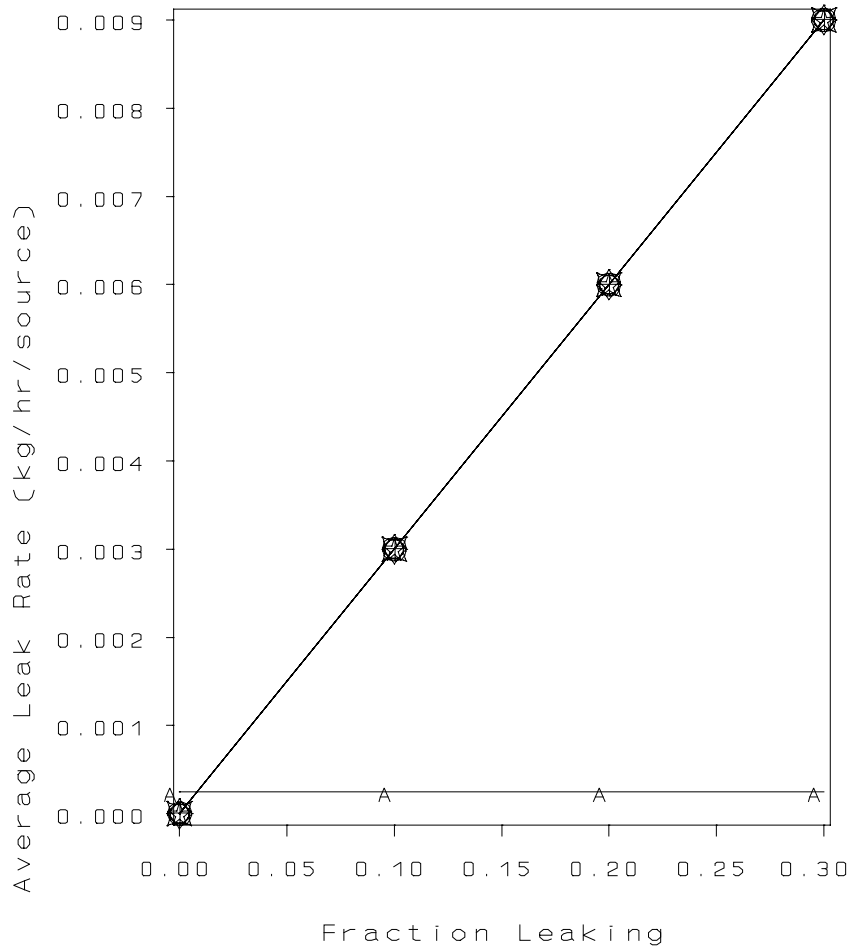

Figure 5-23. Oil and Gas Production Light Oil Open-Ended Lines Average Leak Rate Versus Fraction Leaking at Several Leak Definitions

Average Leak Rate Curves

Oil & Gas Production – Water/Oil Open-Ended Lines



Leak Definition:

- | | |
|-----------------|-------------------|
| ⊕⊕⊕ 500 ppmv | ⊠⊠⊠ 1,000 ppmv |
| ◇◇◇ 2,000 ppmv | ⊖⊖⊖ 5,000 ppmv |
| ☆☆☆ 10,000 ppmv | —A—A—A Avg Factor |

Figure 5-24. Oil and Gas Production Water/Oil Open-Ended Lines Average Leak Rate Versus Fraction Leaking at Several Leak Definitions

Average Leak Rate Curves Oil & Gas Production – Gas Other

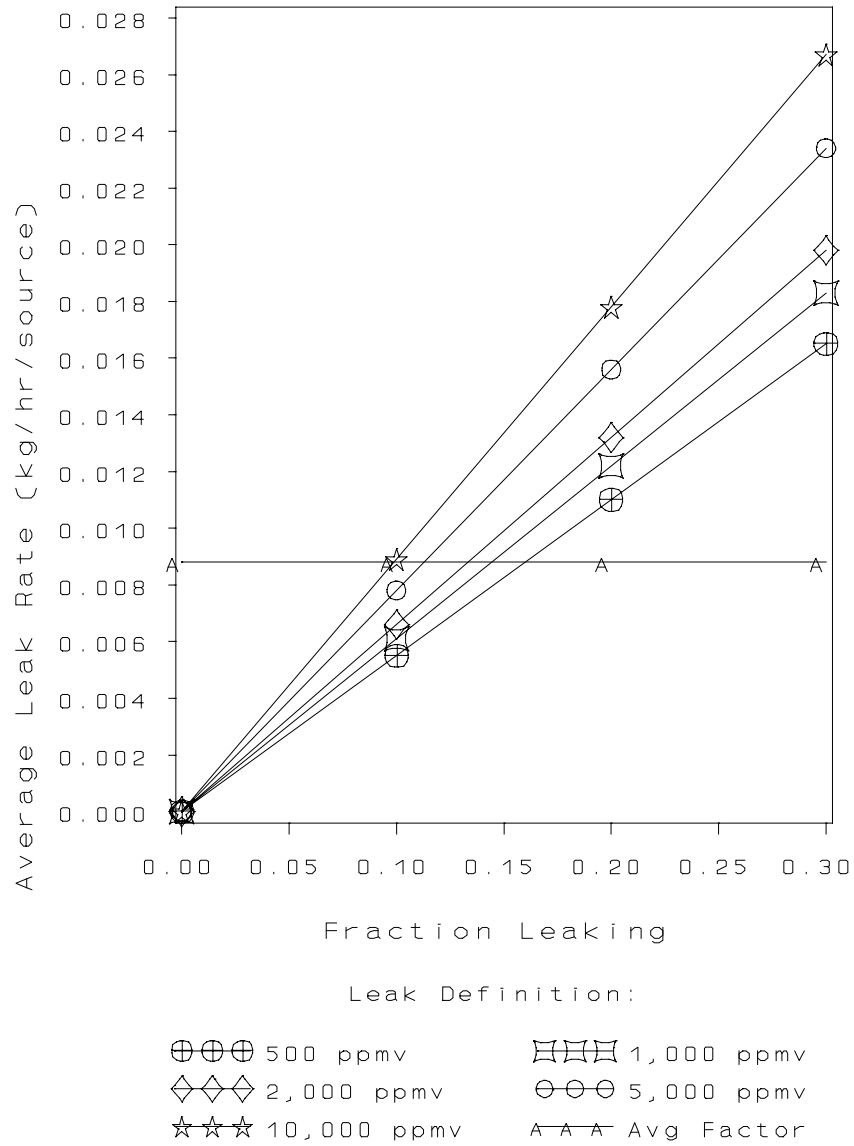

Figure 5-25. Oil and Gas Production Gas Other Average Leak Rate Versus Fraction Leaking at Several Leak Definitions

Average Leak Rate Curves Oil & Gas Production – Heavy Oil Other

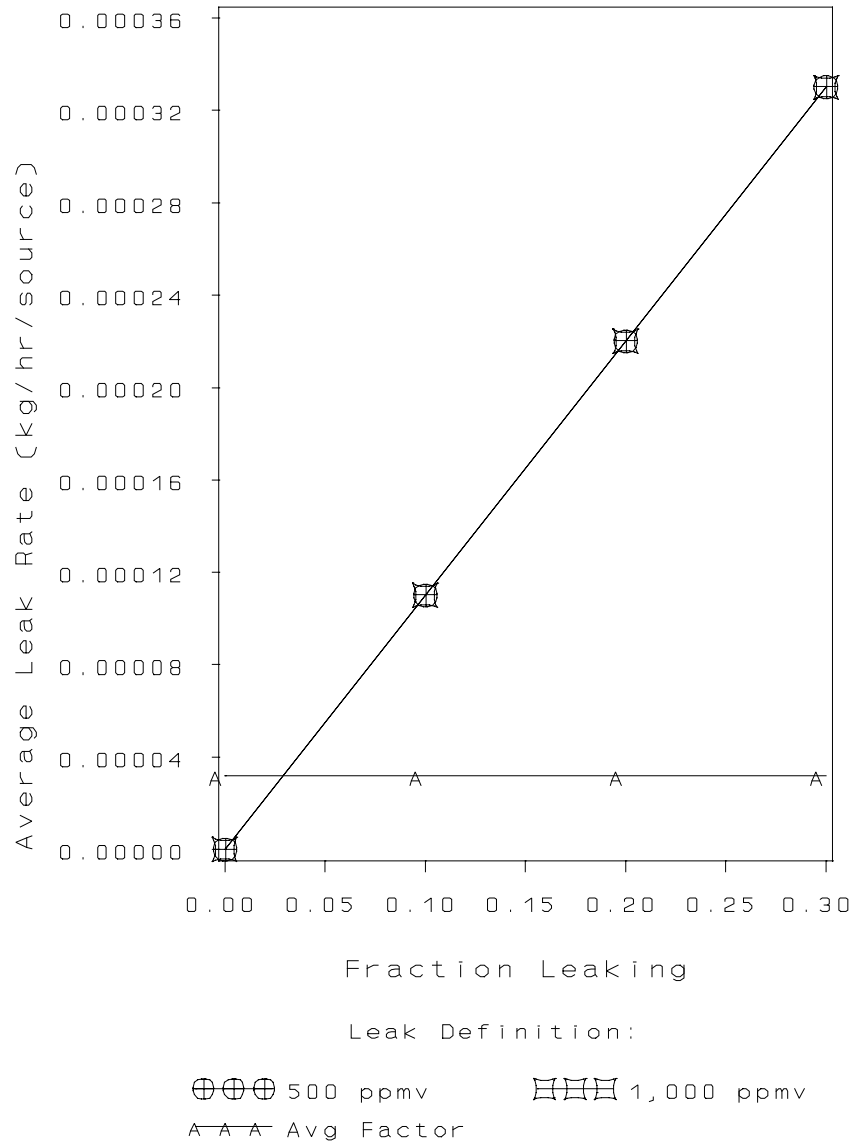

Figure 5-26. Oil and Gas Production Heavy Oil Other Average Leak Rate Versus Fraction Leaking at Several Leak Definitions

Average Leak Rate Curves Oil & Gas Production – Light Oil Other

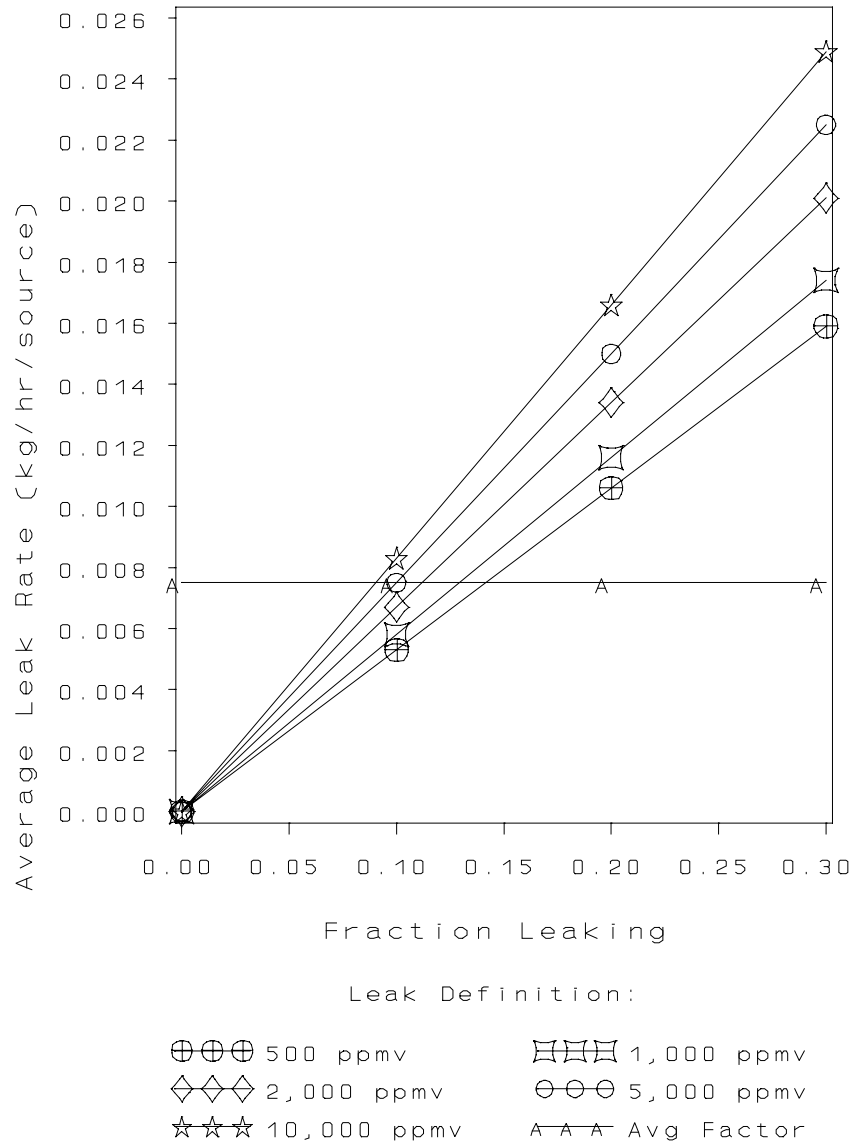

Figure 5-27. Oil and Gas Production Light Oil Other Average Leak Rate Versus Fraction Leaking at Several Leak Definitions

Average Leak Rate Curves Oil & Gas Production – Water/Oil Other

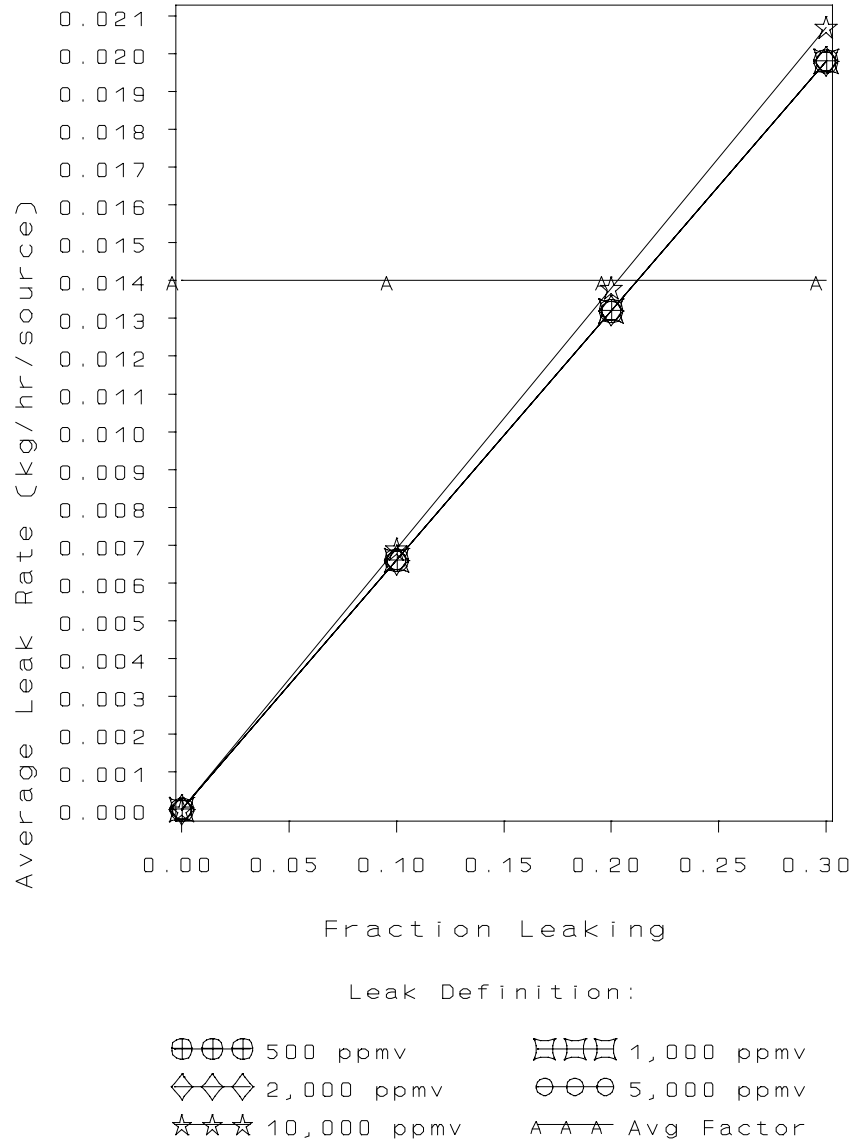

Figure 5-28. Oil and Gas Production Water/Oil Other Average Leak Rate Versus Fraction Leaking at Several Leak Definitions

Average Leak Rate Curves Oil & Gas Production – Gas Pumps

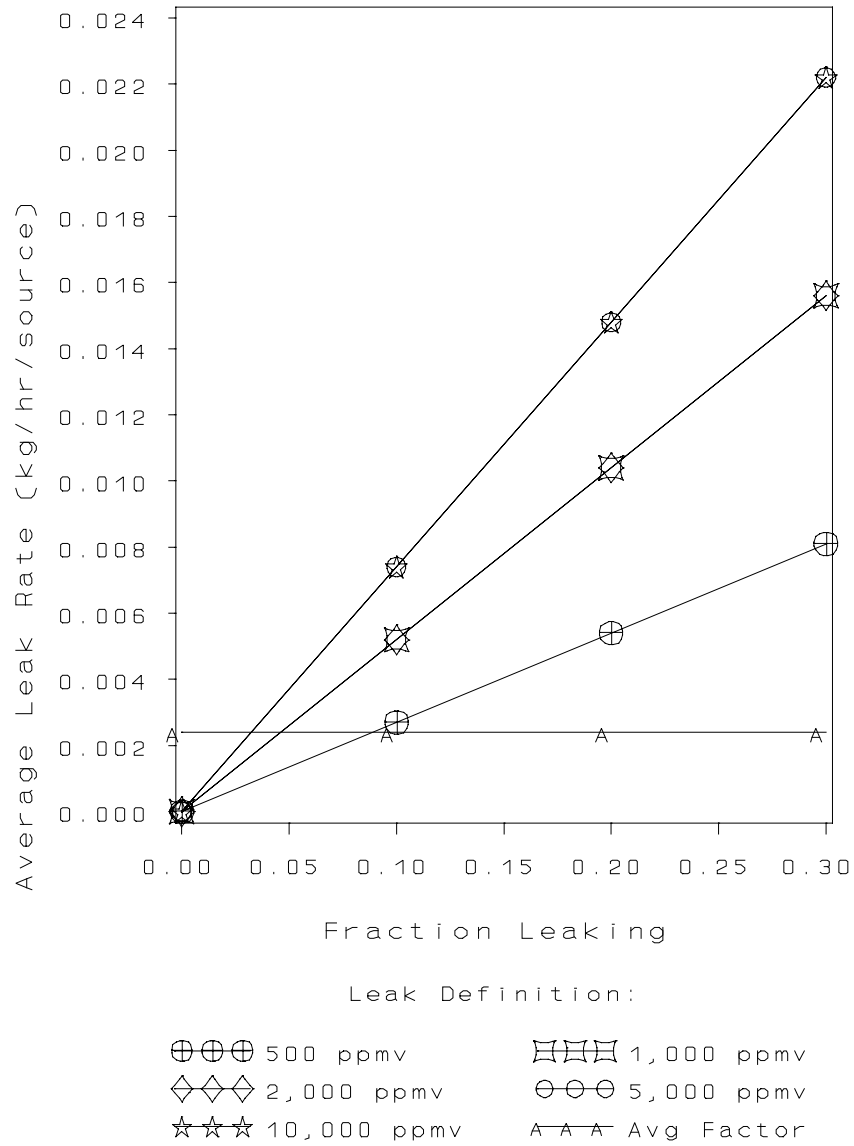

Figure 5-29. Oil and Gas Production Gas Pump Average Leak Rate Versus Fraction Leaking at Several Leak Definitions

Average Leak Rate Curves Oil & Gas Production – Light Oil Pumps

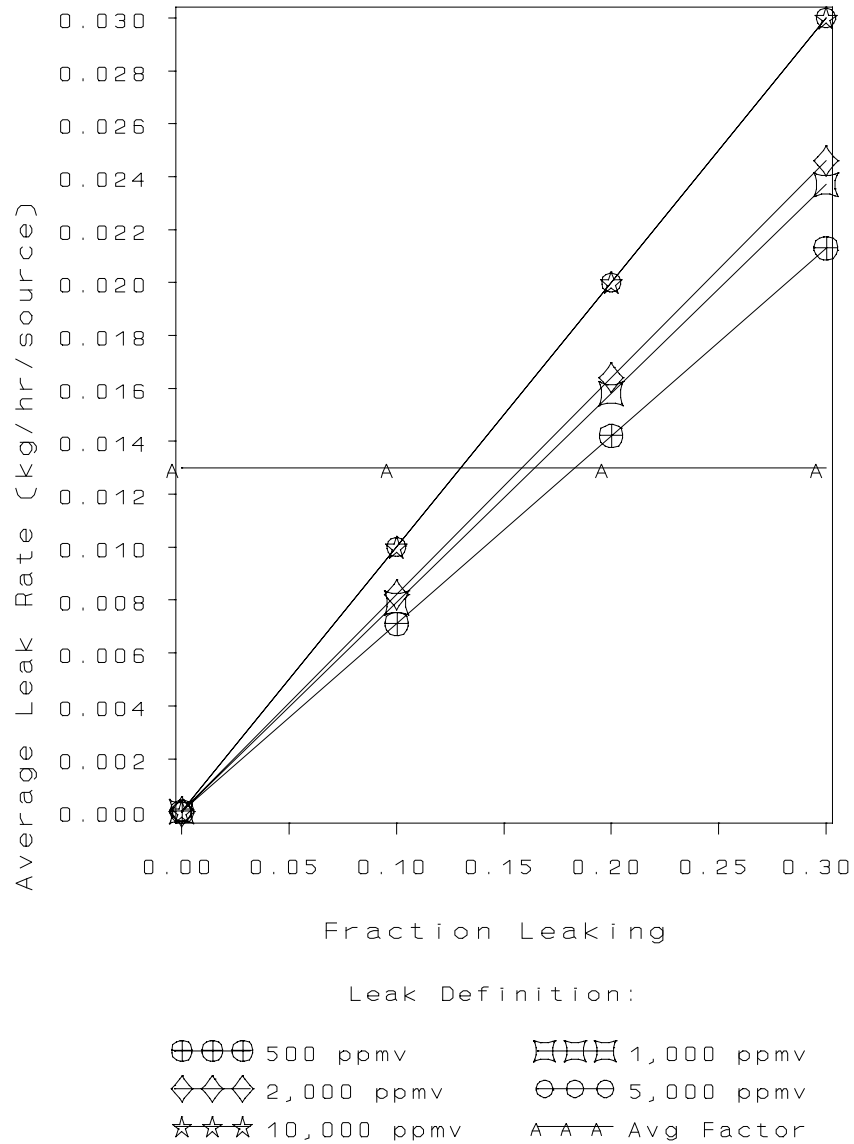

Figure 5-30. Oil and Gas Production Light Oil Pumps Average Leak Rate Versus Fraction Leaking at Several Leak Definitions

Average Leak Rate Curves Oil & Gas Production – Gas Valves

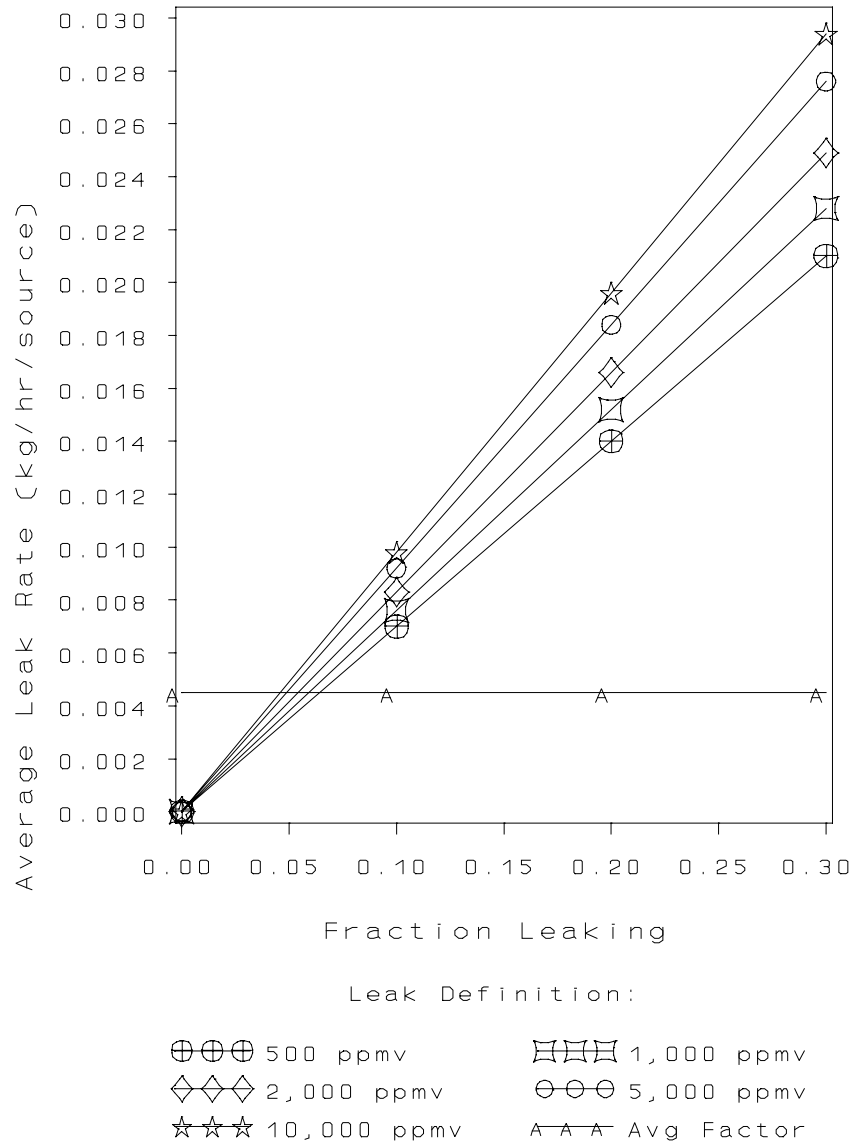

Figure 5-31. Oil and Gas Production Gas Valves Average Leak Rate Versus Fraction Leaking at Several Leak Definitions

Average Leak Rate Curves Oil & Gas Production – Heavy Oil Valves

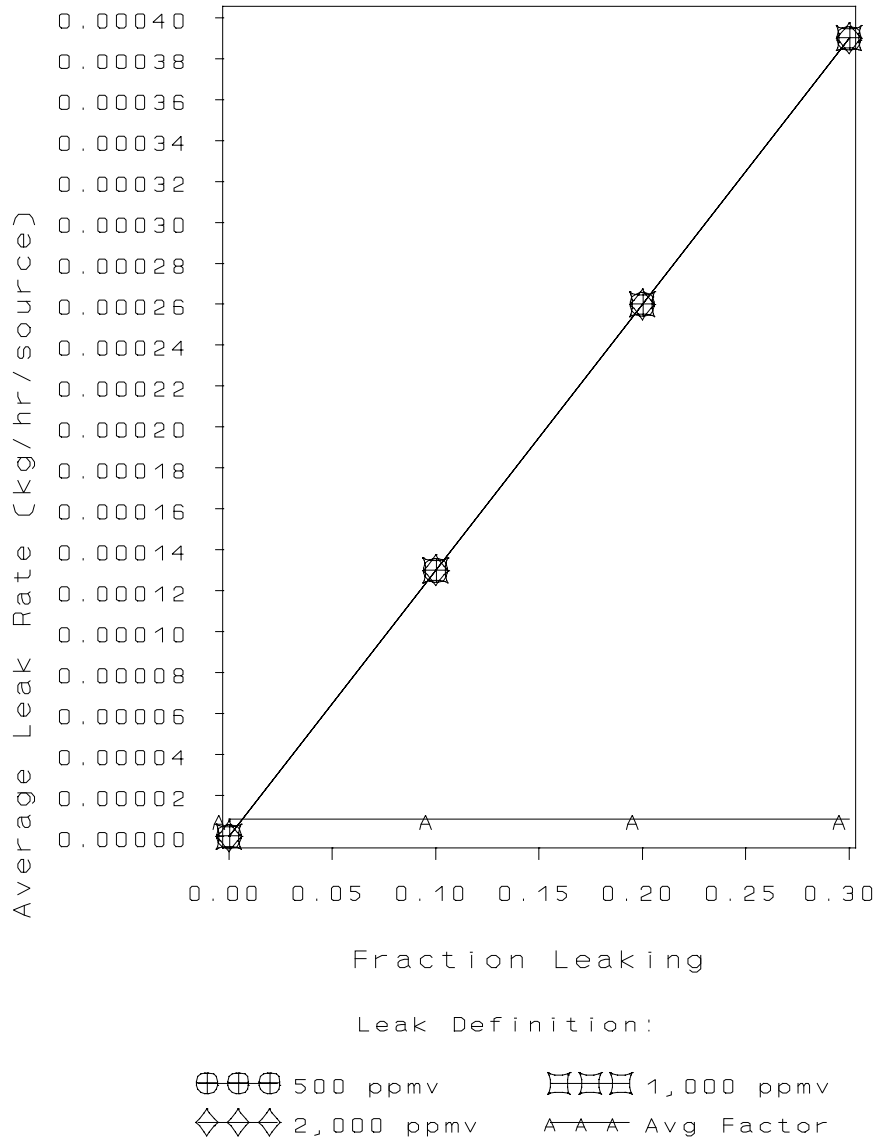

Figure 5-32. Oil and Gas Production Heavy Oil Valves Average Leak Rate Versus Fraction Leaking at Several Leak Definitions

Average Leak Rate Curves Oil & Gas Production – Light Oil Valves

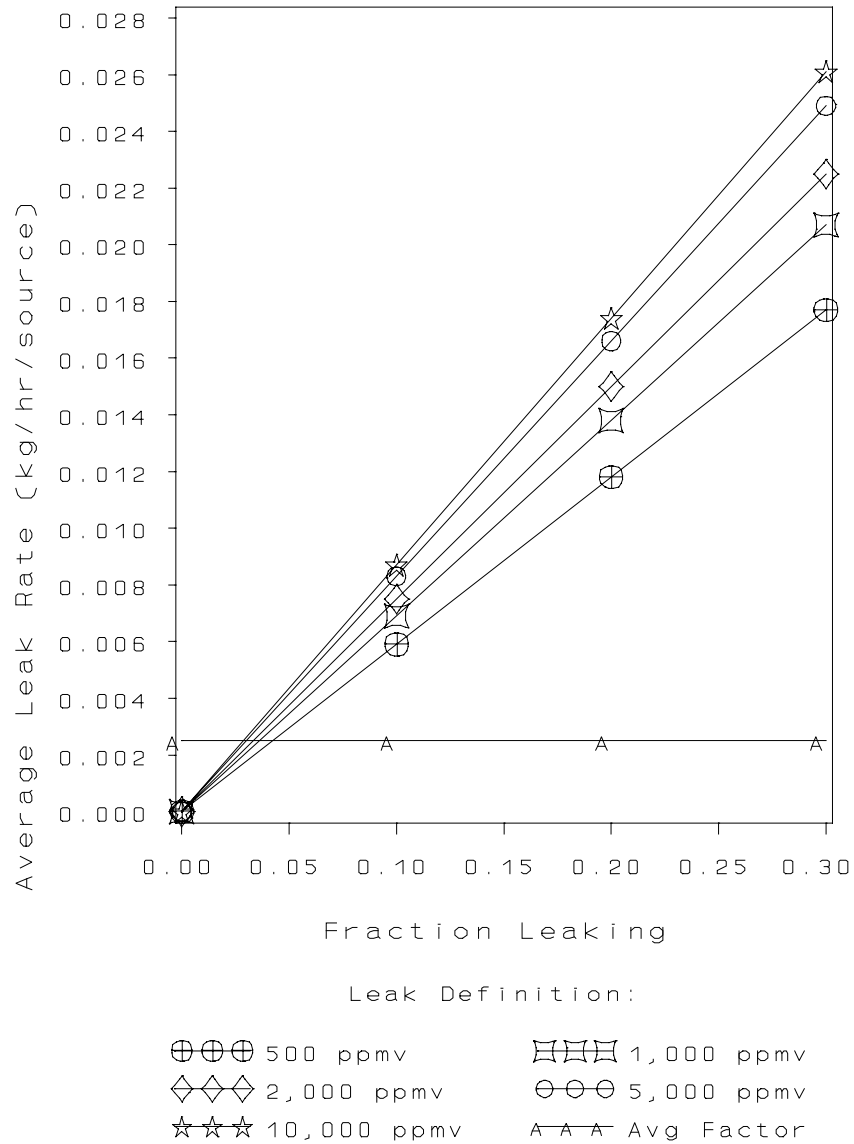

Figure 5-33. Oil and Gas Production Light Oil Valves Average Leak Rate Versus Fraction Leaking at Several Leak Definitions

Average Leak Rate Curves Oil & Gas Production – Water/Oil Valves

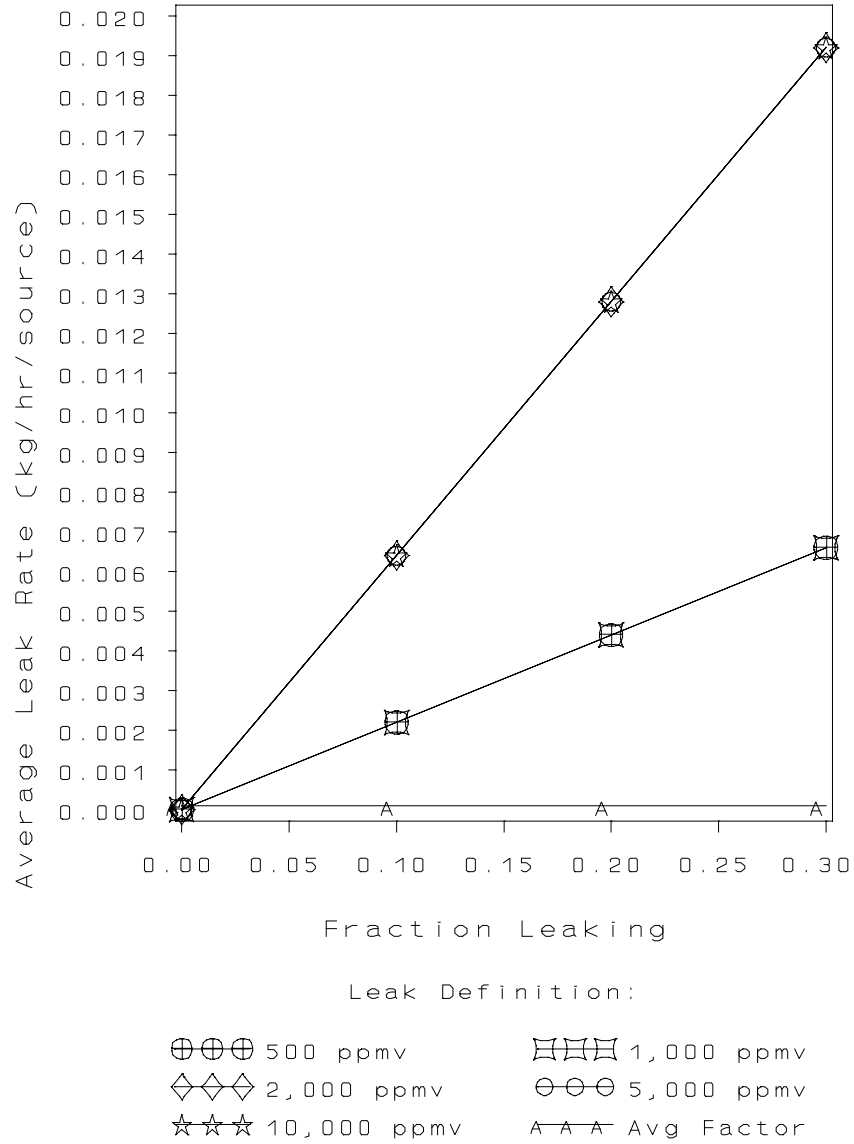

Figure 5-34. Oil and Gas Production Water/Oil Valves Average Leak Rate Versus Fraction Leaking at Several Leak Definitions

TABLE 5-4. EQUATIONS RELATING AVERAGE LEAK RATE TO FRACTION LEAKING AT SOCMI UNITS

Equipment type	Leak definition (ppmv)	Equations ^a	
Gas valve	500	ALR = (0.044 × LKFRAC)	+ 1.7E-05
	1000	ALR = (0.050 × LKFRAC)	+ 2.8E-05
	2000	ALR = (0.057 × LKFRAC)	+ 4.3E-05
	5000	ALR = (0.068 × LKFRAC)	+ 8.1E-05
	10000	ALR = (0.078 × LKFRAC)	+ 1.3E-04
Light liquid valve	500	ALR = (0.047 × LKFRAC)	+ 2.7E-05
	1000	ALR = (0.053 × LKFRAC)	+ 3.9E-05
	2000	ALR = (0.061 × LKFRAC)	+ 5.9E-05
	5000	ALR = (0.077 × LKFRAC)	+ 1.1E-04
	10000	ALR = (0.089 × LKFRAC)	+ 1.7E-04
Light liquid pump	500	ALR = (0.095 × LKFRAC)	+ 3.1E-04
	1000	ALR = (0.11 × LKFRAC)	+ 4.6E-04
	2000	ALR = (0.13 × LKFRAC)	+ 6.7E-04
	5000	ALR = (0.20 × LKFRAC)	+ 1.4E-03
	10000	ALR = (0.24 × LKFRAC)	+ 1.9E-03
Connector	500	ALR = (0.047 × LKFRAC)	+ 1.7E-05
	1000	ALR = (0.060 × LKFRAC)	+ 2.5E-05
	2000	ALR = (0.073 × LKFRAC)	+ 3.5E-05
	5000	ALR = (0.092 × LKFRAC)	+ 5.4E-05
	10000	ALR = (0.11 × LKFRAC)	+ 8.1E-05

^aALR = Average leak rate (kg/hr per source) and LKFRAC = leak fraction.

TABLE 5-5. EQUATIONS RELATING AVERAGE LEAK RATE TO FRACTION LEAKING AT REFINERY UNITS

Equipment type	Leak definition (ppmv)	Equation ^a
Gas valve	500	$ALR = (0.11 \times LKFRAC) + 8.8E-05$
	1000	$ALR = (0.13 \times LKFRAC) + 1.4E-04$
	10000	$ALR = (0.26 \times LKFRAC) + 6.0E-04$
Light liquid valve	500	$ALR = (0.038 \times LKFRAC) + 2.0E-04$
	1000	$ALR = (0.042 \times LKFRAC) + 2.8E-04$
	10000	$ALR = (0.084 \times LKFRAC) + 1.7E-03$
Light liquid pump	500	$ALR = (0.20 \times LKFRAC) + 1.3E-03$
	1000	$ALR = (0.23 \times LKFRAC) + 2.0E-03$
	10000	$ALR = (0.43 \times LKFRAC) + 1.2E-02$
Connector	500	$ALR = (0.014 \times LKFRAC) + 1.3E-05$
	1000	$ALR = (0.017 \times LKFRAC) + 1.8E-05$
	10000	$ALR = (0.037 \times LKFRAC) + 6.0E-05$

^aALR = Average leak rate (kg/hr per source) and LKFRAC = leak fraction.

TABLE 5-6. EQUATIONS RELATING AVERAGE LEAK RATE TO FRACTION LEAKING AT MARKETING TERMINAL UNITS

Equipment Type	Leak Definition (ppmv)	Equation ^a
Gas Connector	500	$ALR = (0.017 \times LKFRAC) + 5.3E-06$
	1000	$ALR = (0.017 \times LKFRAC) + 5.3E-06$
	2000	$ALR = (0.034 \times LKFRAC) + 5.9E-06$
	5000	$ALR = (0.034 \times LKFRAC) + 5.9E-06$
	10000	$ALR = (0.034 \times LKFRAC) + 5.9E-06$
Light Liquid Connector	500	$ALR = (0.0021 \times LKFRAC) + 7.0E-06$
	1000	$ALR = (0.0028 \times LKFRAC) + 7.1E-06$
	2000	$ALR = (0.0042 \times LKFRAC) + 7.1E-06$
	5000	$ALR = (0.0058 \times LKFRAC) + 7.2E-06$
	10000	$ALR = (0.0065 \times LKFRAC) + 7.2E-06$
Gas Other	500	$ALR = (0.0018 \times LKFRAC) + 3.1E-05$
	1000	$ALR = (0.0021 \times LKFRAC) + 4.0E-05$
	2000	$ALR = (0.0023 \times LKFRAC) + 4.8E-05$
	5000	$ALR = (0.0029 \times LKFRAC) + 8.4E-05$
	10000	$ALR = 1.2E-04$
Light Liquid Other	500	$ALR = (0.019 \times LKFRAC) + 2.1E-05$
	1000	$ALR = (0.022 \times LKFRAC) + 2.2E-05$
	2000	$ALR = (0.025 \times LKFRAC) + 2.2E-05$
	5000	$ALR = (0.034 \times LKFRAC) + 2.4E-05$
	10000	$ALR = (0.034 \times LKFRAC) + 2.4E-05$
Light Liquid Pump	500	$ALR = (0.014 \times LKFRAC) + 9.6E-05$
	1000	$ALR = (0.018 \times LKFRAC) + 1.2E-04$
	2000	$ALR = (0.029 \times LKFRAC) + 1.6E-04$
	5000	$ALR = (0.051 \times LKFRAC) + 2.1E-04$
	10000	$ALR = (0.077 \times LKFRAC) + 2.4E-04$

TABLE 5-6. EQUATIONS RELATING AVERAGE LEAK RATE TO FRACTION LEAKING AT MARKETING TERMINAL UNITS (CONTINUED)

Equipment Type	Leak Definition (ppmv)	Equation ^a
Gas Valve	500	$ALR = (0.0012 \times LKFRAC) + 8.9E-06$
	1000	$ALR = (0.0017 \times LKFRAC) + 9.2E-06$
	2000	$ALR = (0.0017 \times LKFRAC) + 9.2E-06$
	5000	$ALR = (0.0017 \times LKFRAC) + 9.2E-06$
	10000	$ALR = 1.3E-05$
Light Liquid Valve	500	$ALR = (0.0045 \times LKFRAC) + 9.5E-06$
	1000	$ALR = (0.0052 \times LKFRAC) + 9.8E-06$
	2000	$ALR = (0.0077 \times LKFRAC) + 1.1E-05$
	5000	$ALR = (0.013 \times LKFRAC) + 1.2E-05$
	10000	$ALR = (0.023 \times LKFRAC) + 1.5E-05$

^aALR = Average leak rate (kg/hr per source)
LKFRAC = Leak fraction.

TABLE 5-7. EQUATIONS RELATING AVERAGE LEAK RATE TO FRACTION LEAKING AT OIL AND GAS PRODUCTION OPERATION UNITS

Equipment Type	Leak Definition (ppmv)	Equation ^a
Gas Connector	500	$ALR = (0.016 \times LKFRAC) + 7.7E-06$
	1000	$ALR = (0.018 \times LKFRAC) + 8.0E-06$
	2000	$ALR = (0.020 \times LKFRAC) + 8.5E-06$
	5000	$ALR = (0.023 \times LKFRAC) + 9.4E-06$
	10000	$ALR = (0.026 \times LKFRAC) + 1.0E-05$
Light Oil Connector	500	$ALR = (0.016 \times LKFRAC) + 7.7E-06$
	1000	$ALR = (0.021 \times LKFRAC) + 8.3E-06$
	2000	$ALR = (0.022 \times LKFRAC) + 8.6E-06$
	5000	$ALR = (0.025 \times LKFRAC) + 9.2E-06$
	10000	$ALR = (0.026 \times LKFRAC) + 9.7E-06$
Water/Oil Connector	500	$ALR = (0.013 \times LKFRAC) + 7.8E-06$
	1000	$ALR = (0.014 \times LKFRAC) + 7.9E-06$
	2000	$ALR = (0.016 \times LKFRAC) + 8.3E-06$
	5000	$ALR = (0.023 \times LKFRAC) + 9.4E-06$
	10000	$ALR = (0.028 \times LKFRAC) + 1.0E-05$
Gas Flange	500	$ALR = (0.043 \times LKFRAC) + 1.1E-06$
	1000	$ALR = (0.051 \times LKFRAC) + 1.8E-06$
	2000	$ALR = (0.059 \times LKFRAC) + 2.6E-06$
	5000	$ALR = (0.075 \times LKFRAC) + 4.7E-06$
	10000	$ALR = (0.082 \times LKFRAC) + 5.7E-06$
Light Oil Flange	500	$ALR = (0.037 \times LKFRAC) + 9.4E-07$
	1000	$ALR = (0.046 \times LKFRAC) + 1.2E-06$
	2000	$ALR = (0.055 \times LKFRAC) + 1.6E-06$
	5000	$ALR = (0.068 \times LKFRAC) + 2.1E-06$
	10000	$ALR = (0.073 \times LKFRAC) + 2.4E-06$

TABLE 5-7. EQUATIONS RELATING AVERAGE LEAK RATE TO FRACTION
LEAKING AT OIL AND GAS PRODUCTION OPERATION UNITS
(CONTINUED)

Equipment Type	Leak Definition (ppmv)	Equation ^a
Gas Open-Ended Line	500	$ALR = (0.037 \times LKFRAC) + 4.1E-06$
	1000	$ALR = (0.039 \times LKFRAC) + 5.0E-06$
	2000	$ALR = (0.045 \times LKFRAC) + 7.5E-06$
	5000	$ALR = (0.051 \times LKFRAC) + 1.2E-05$
	10000	$ALR = (0.055 \times LKFRAC) + 1.5E-05$
Heavy Oil Open-Ended Line	500	$ALR = (0.012 \times LKFRAC) + 4.3E-06$
	1000	$ALR = (0.015 \times LKFRAC) + 4.9E-06$
	2000	$ALR = (0.020 \times LKFRAC) + 6.0E-06$
	5000	$ALR = (0.030 \times LKFRAC) + 7.2E-06$
	10000	$ALR = (0.030 \times LKFRAC) + 7.2E-06$
Light Oil Open-Ended Line	500	$ALR = (0.030 \times LKFRAC) + 3.8E-06$
	1000	$ALR = (0.032 \times LKFRAC) + 4.7E-06$
	2000	$ALR = (0.036 \times LKFRAC) + 6.7E-06$
	5000	$ALR = (0.040 \times LKFRAC) + 9.7E-06$
	10000	$ALR = (0.044 \times LKFRAC) + 1.4E-05$
Water/Oil Open-Ended Line	500	$ALR = (0.030 \times LKFRAC) + 3.5E-06$
	1000	$ALR = (0.030 \times LKFRAC) + 3.5E-06$
	2000	$ALR = (0.030 \times LKFRAC) + 3.5E-06$
	5000	$ALR = (0.030 \times LKFRAC) + 3.5E-06$
	10000	$ALR = (0.030 \times LKFRAC) + 3.5E-06$
Gas Other	500	$ALR = (0.055 \times LKFRAC) + 1.8E-05$
	1000	$ALR = (0.061 \times LKFRAC) + 3.1E-05$
	2000	$ALR = (0.066 \times LKFRAC) + 4.5E-05$
	5000	$ALR = (0.078 \times LKFRAC) + 8.2E-05$
	10000	$ALR = (0.089 \times LKFRAC) + 1.2E-04$

TABLE 5-7. EQUATIONS RELATING AVERAGE LEAK RATE TO FRACTION
LEAKING AT OIL AND GAS PRODUCTION OPERATION UNITS
(CONTINUED)

Equipment Type	Leak Definition (ppmv)	Equation ^a
Heavy Oil Other	500	$ALR = (0.0011 \times LKFRAC) + 2.1E-05$
	1000	$ALR = (0.0011 \times LKFRAC) + 2.1E-05$
	2000	$ALR = 3.2E-05$
	5000	$ALR = 3.2E-05$
	10000	$ALR = 3.2E-05$
Light Oil Other	500	$ALR = (0.053 \times LKFRAC) + 3.4E-05$
	1000	$ALR = (0.058 \times LKFRAC) + 4.4E-05$
	2000	$ALR = (0.067 \times LKFRAC) + 6.4E-05$
	5000	$ALR = (0.075 \times LKFRAC) + 8.6E-05$
	10000	$ALR = (0.083 \times LKFRAC) + 1.4E-04$
Water/Oil Other	500	$ALR = (0.066 \times LKFRAC) + 2.5E-05$
	1000	$ALR = (0.066 \times LKFRAC) + 2.5E-05$
	2000	$ALR = (0.066 \times LKFRAC) + 2.5E-05$
	5000	$ALR = (0.066 \times LKFRAC) + 2.5E-05$
	10000	$ALR = (0.069 \times LKFRAC) + 5.9E-05$
Gas Pump	500	$ALR = (0.027 \times LKFRAC) + 1.1E-04$
	1000	$ALR = (0.052 \times LKFRAC) + 2.3E-04$
	2000	$ALR = (0.052 \times LKFRAC) + 2.3E-04$
	5000	$ALR = (0.074 \times LKFRAC) + 3.5E-04$
	10000	$ALR = (0.074 \times LKFRAC) + 3.5E-04$
Light Oil Pump	500	$ALR = (0.071 \times LKFRAC) + 7.9E-05$
	1000	$ALR = (0.079 \times LKFRAC) + 1.5E-04$
	2000	$ALR = (0.082 \times LKFRAC) + 1.9E-04$
	5000	$ALR = (0.10 \times LKFRAC) + 5.1E-04$
	10000	$ALR = (0.10 \times LKFRAC) + 5.1E-04$

TABLE 5-7. EQUATIONS RELATING AVERAGE LEAK RATE TO FRACTION
LEAKING AT OIL AND GAS PRODUCTION OPERATION UNITS
(CONTINUED)

Equipment Type	Leak Definition (ppmv)	Equation ^a
Gas Valve	500	$ALR = (0.070 \times LKFRAC) + 9.1E-06$
	1000	$ALR = (0.076 \times LKFRAC) + 1.1E-05$
	2000	$ALR = (0.083 \times LKFRAC) + 1.4E-05$
	5000	$ALR = (0.092 \times LKFRAC) + 1.9E-05$
	10000	$ALR = (0.098 \times LKFRAC) + 2.5E-05$
Heavy Oil Valve	500	$ALR = (0.0013 \times LKFRAC) + 7.8E-06$
	1000	$ALR = (0.0013 \times LKFRAC) + 7.8E-06$
	2000	$ALR = (0.0013 \times LKFRAC) + 7.8E-06$
	5000	$ALR = 8.4E-06$
	10000	$ALR = 8.4E-06$
Light Oil Valve	500	$ALR = (0.059 \times LKFRAC) + 9.4E-06$
	1000	$ALR = (0.069 \times LKFRAC) + 1.2E-05$
	2000	$ALR = (0.075 \times LKFRAC) + 1.4E-05$
	5000	$ALR = (0.083 \times LKFRAC) + 1.7E-05$
	10000	$ALR = (0.087 \times LKFRAC) + 1.9E-05$
Water/Light Oil Valve	500	$ALR = (0.022 \times LKFRAC) + 8.1E-06$
	1000	$ALR = (0.022 \times LKFRAC) + 8.1E-06$
	2000	$ALR = (0.064 \times LKFRAC) + 9.7E-06$
	5000	$ALR = (0.064 \times LKFRAC) + 9.7E-06$
	10000	$ALR = (0.064 \times LKFRAC) + 9.7E-06$

^aALR = Average leak rate (kg/hr per source)
LKFRAC = Leak fraction.

The initial leak frequency is the fraction of sources defined as leaking before the LDAR program is implemented. The initial leak frequency is point X on figure 5-35. The lower the leak definition, the higher the initial leak frequency. At a process unit, the initial leak frequency can be determined based on collected screening data. If no screening data are available, the initial leak frequency can be assumed to be equivalent to the leak frequency associated with the applicable average emission factor. However, if a process unit already has some type of LDAR program in place, the average emission factor may overestimate emissions.

On figures 5-1 through 5-34, the average emission factor for each equipment type is plotted as a horizontal line. From this line, an initial leak frequency can be determined for any of the leak definitions. For example, on figure 5-1, which is for gas valves, the SOCFI average emission factor equals 0.00597 kilograms per hour (kg/hr). For a leak definition of 500 ppmv, this average emission factor corresponds to a fraction leaking of approximately 0.136. Similarly, for a leak definition of 10,000 ppmv, the average emission factor corresponds to a fraction leaking of 0.075. These points are determined by finding the intersection of the SOCFI average emission factor line and the applicable leak definition line and reading off the corresponding fraction leaking. Alternatively the fraction leaking associated with the average factor can be calculated using the equations in tables 5-4, 5-5, 5-6, and 5-7.

The leak frequency immediately after a monitoring cycle is Point Y on figure 5-35. After an LDAR program is implemented for a given time period, point Y will reach a "steady-state" value. As presented in figure 5-35, point Y depends on two key factors: (1) the percentage of equipment successfully repaired after being identified as leaking, and (2) the percentage of equipment that was repaired for which leaks recurred. Two simplifying assumptions when calculating point Y are: (1) that leaking equipment is instantaneously repaired, and (2) that the recurring leaks will occur instantaneously after the equipment is repaired.

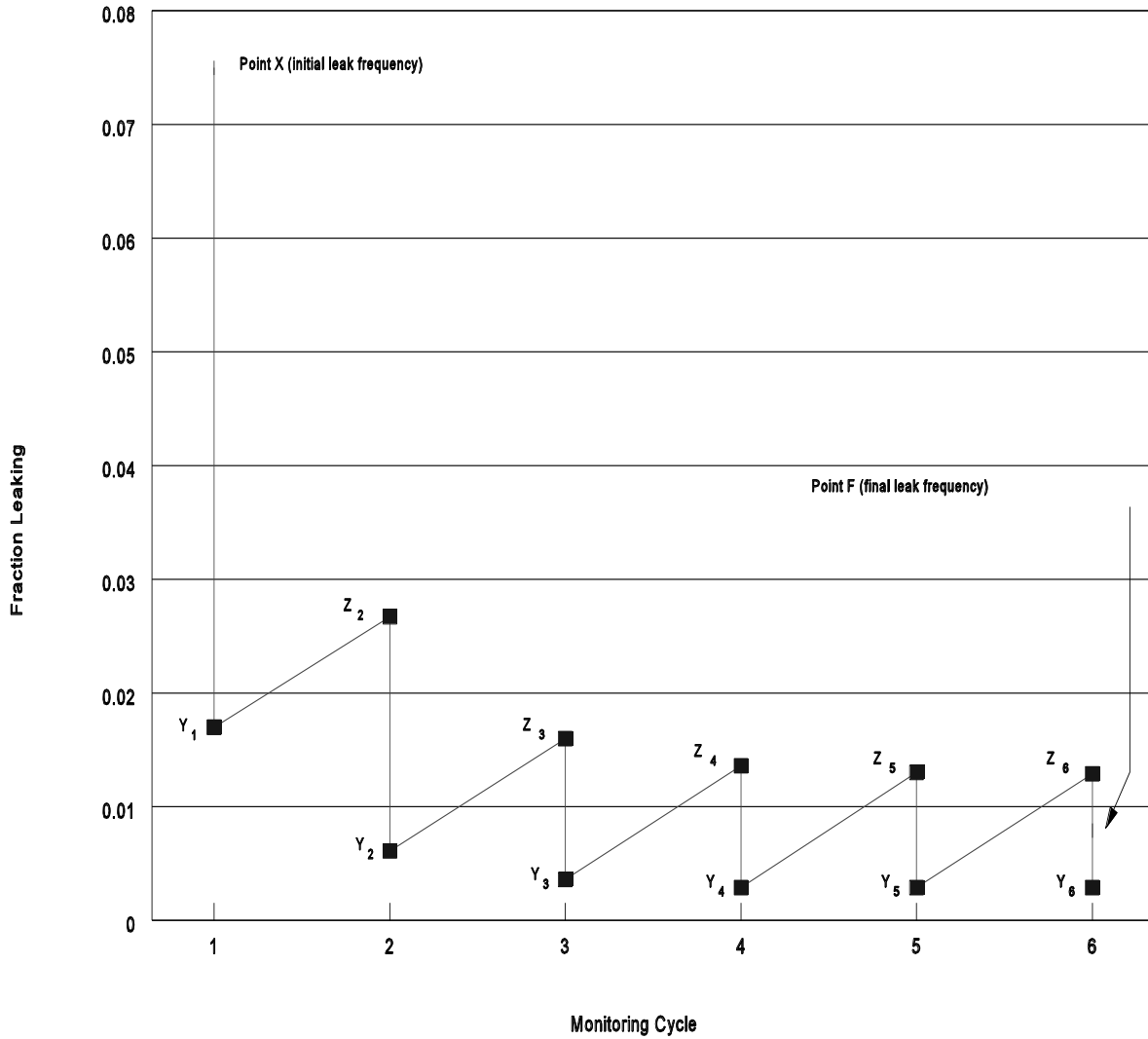

Figure 5-35. Simplified Graphical Presentation of Changes in Leak Frequency After Implementation of an LDAR Program

Based on these assumptions the value for point Y is calculated using the following equation:

$$Y_i = Z_i - (FR \times Z_i) + (FR \times Z_i \times R)$$

where:

- Y_i = Leak fraction immediately after monitoring cycle i ;
- Z_i = Leak fraction immediately preceding monitoring cycle i (note that Z_1 equals point X.);
- R = Fraction of repaired sources for which a leak immediately recurs; and
- FR = Fraction of leaking sources successfully repaired.

Point Z on figure 5-35 is the leak frequency immediately preceding equipment monitoring. After an LDAR program is implemented for a given time period, point Z will reach a "steady-state" value. To go from point Y to point Z on figure 5-35, the occurrence rate is added to point Y. The occurrence rate equals the percentage of initially nonleaking equipment that starts to leak between monitoring cycles. Use the following equation to go from point Y to point Z:

$$Z_{i+1} = Oc \times (1 - Y_i) + Y_i$$

where:

- Z_{i+1} = Leak fraction immediately preceding monitoring cycle $i + 1$;
- Oc = Fraction of nonleaking sources which will leak in the time period between monitoring cycles (i.e., occurrence rate); and
- Y_i = Leak fraction immediately after monitoring cycle i .

After several monitoring cycles, the leak frequency will be found to approximately oscillate between points Y and Z. The average value of these two "steady-state" values is the final leak frequency. This is point F on figure 5-35. The final leak frequency is the average percent of sources that are still leaking after an LDAR program has been implemented.

Once the initial and final leak frequencies are determined, they can be entered into the applicable equation from table 5-4

or table 5-5 to calculate the associated average leak rates at these leak frequencies. Based on the initial leak rate and the final leak rate, the control effectiveness for an LDAR program can be calculated. The control effectiveness is calculated as:

$$\text{Eff} = (\text{ILR}-\text{FLR})/\text{ILR} \times 100$$

where:

Eff = Control effectiveness (percent);

ILR = Initial leak rate (kg/hr/source); and

FLR = Final leak rate (kg/hr/source).

5.3.2 Example Application of Approach

As previously mentioned, the approach described in section 5.3.1 was applied to estimate the control effectiveness for three types of LDAR programs: (1) monthly inspection with a leak definition of 10,000 ppmv, (2) quarterly inspection with a leak definition of 10,000 ppmv, and (3) a program complying with the requirements specified in the proposed hazardous organic NESHAP equipment leaks negotiated regulation.¹ Details of these calculations are presented in appendix G. As an example of applying the approach, the control effectiveness for gas valves at a SOCFI process unit implementing a monthly LDAR program with a leak definition of 10,000 ppmv is presented in the following paragraphs.

Table 5-8 presents the SOCFI gas valve occurrence rate, recurrence rate, unsuccessful repair rate, and initial leak frequency. (See appendix G for details on how each of these parameters were determined.) Using the values presented in table 5-6 and the approach presented in section 5.3.1, the LDAR control effectiveness can be calculated. Note that figure 5-9 is also based on monthly monitoring of gas valves in a SOCFI process unit with a leak definition of 10,000 ppmv, and it is referred to in this example demonstration.

For gas valves with a leak definition of 10,000 ppmv, the initial leak frequency is 7.5 percent. This initial leak frequency value is taken from figure 5-1, by finding the value of

TABLE 5-8. VALUES USED IN EXAMPLE CALCULATION^a

Source Category:	SOCMI
Equipment Type:	Gas Valves
LDAR Program:	Monthly Monitoring with a Leak Definition of 10,000 ppmv
Occurrence Rate:	1.00%
Recurrence Rate:	14%
Unsuccessful Repair Rate:	10%
Initial Leak Frequency: ^b	7.5%

^aSee appendix F for information on how the occurrence rate, recurrence rate, and unsuccessful repair rate were determined.

^bBased on the SOCMI average emission factor for gas valves.

the fraction leaking at the intersection of the SOCFI average factor line and the 10,000-ppmv leak definition line. The initial leak rate for this leak frequency is the SOCFI gas valve average emission factor, which equals 0.00597. After the LDAR program is implemented and monitoring occurs on a monthly basis, the steady-state leak frequency immediately after monitoring (see point Y₆ on figure 5-35) equals 0.29 percent. The steady-state leak frequency prior to monitoring (see point Z₆ on figure 5-35) equals 1.29 percent. This gives an average of 0.79 percent as the final leak frequency (see point F on figure 5-35). The calculations performed to determine the final leak frequency are shown in table 5-9. Once the estimated gas valve final leak frequency is determined, the associated leak rate can be found using figure 5-1 or the gas valve equation for a leak definition of 10,000 ppmv listed on table 5-4. The corresponding leak rate associated with the final leak frequency of 0.79 percent at a leak definition of 10,000 ppmv is 0.00075 kg/hr. Thus, the control effectiveness of a monthly LDAR program with a leak definition of 10,000 ppmv for gas valves is:

$$\begin{aligned} &= (0.00597 - 0.00075) / 0.00597 \times 100 \\ &= 87 \text{ percent.} \end{aligned}$$

TABLE 5-9. EXAMPLE CALCULATION TO DETERMINE THE FINAL LEAK FREQUENCY OF SOCOMI GAS VALVES IN A MONTHLY MONITORING LDAR PROGRAM WITH A LEAK DEFINITION OF 10,000 PPMV^a

Starting parameters		Resulting parameters	
1.	Leak definition: = 10,000 ppmv	1.	Steady-state leak frequency after monitoring (Point Y ₆): = 0.29 percent
2.	Leak occurrence (O _c): = 1.00 percent	2.	Steady-state leak frequency immediately prior to monitoring (Point Z ₆): = 1.29 percent
3.	Leak recurrence (R): = 14 percent	3.	Final leak frequency (Point F) ^b : = 0.79 percent
4.	Successful repair rate (FR): = 90 percent		
5.	Initial leak frequency (Point X): = 7.5 percent		

<u>Calculations</u>			
Monitoring cycle	Leak frequency after monitoring: Point Y _i (percent) ^c		Leak frequency prior to monitoring: Point Z _i (percent) ^d
	1	1.70	7.50
2	0.61	2.67	
3	0.36	1.60	
4	0.31	1.36	
5	0.29	1.30	
6 ^e	0.29	1.29	

5-60

^aRefer to Figure 5-4 for graphical presentation of all points identified in this table.

^bFinal Leak Frequency equals the average of the prior to monitoring and after monitoring steady-state leak frequencies.

$${}^cY_i = Z_i - (FR * Z_i) + (FR * Z_i * R)$$

$${}^dZ_{i+1} = O_c * (1 - Y_i) + Y_i$$

^eAfter the sixth monitoring cycle, the values for Y_i and Z_i reach steady-state.

5.4 REFERENCES

1. National Emission Standards for Hazardous Air Pollutants for Source Categories; Organic Hazardous Air Pollutants from the Synthetic Organic Chemical Manufacturing Industry and Seven Other Processes. Subpart H--Equipment Leaks. Federal Register. Vol. 57, No. 252, pp 62765-62785. Washington, DC. Office of the Federal Register. December 31, 1992.

APPENDIX A: EXAMPLE CALCULATIONS

A-1. INTRODUCTION

This appendix provides example calculations demonstrating the approaches described in chapter 2.0. A simple dataset from a hypothetical process unit is expanded as needed to illustrate how the data are used in each approach. Table A-1 summarizes information used in the example calculations. This information includes the equipment count, hours of operation, and composition for each stream. The stream compositions presented in table A-1 are completely hypothetical and were chosen for the sole purpose of demonstrating the various approaches. Three streams are presented in table A-1. Note that the hours of operation are based on the time in which the equipment contains material. (Even if a process unit is shutdown, if the equipment contains material, then the shutdown time must still be included in the hours of operation.)

Two SOCFI equipment type/service categories are used in the example calculations: pumps/light liquid and valves/gas. The same technique used for these equipment type/service categories can be followed for any equipment type/service. In each of the calculations, emissions are estimated on an annual basis.

The following sections present the example calculations. In section A-2, the Average Emission Factor Approach is presented. Section A-3 presents the Screening Ranges Approach. In section A-4, the EPA Correlation Equation Approach is presented, and in section A-5, the use of the Unit-Specific Correlation is discussed. Section A-6 explains how to speciate emissions. Section A-7 demonstrates three approaches for applying response factors (RF's). Section A-8 demonstrates how to annualize emissions when more than one screening value is collected from individual equipment pieces over an annual time period. Section A-9 shows how to estimate VOC emissions when screening data are collected from equipment containing organic compounds not classified as VOC's. Finally, section A-10 addresses estimating emissions from equipment containing inorganic compounds.

TABLE A-1. DATA FOR EXAMPLE CALCULATIONS

Stream ID	Equipment type/service	Equipment count	Hours of operation ^a (hr/yr)	Stream composition	
				Constituent	wt. fraction
A	Pumps/light liquid	15	8,760	ethyl acrylate	0.80
				water	0.20
B	Pumps/light liquid	12	4,380	ethyl acrylate	0.10
				styrene	0.90
C	Valves/gas	40	8,760	ethyl acrylate	0.65
				ethane	0.25
				water vapor	0.10

^aHours of operation include all time in which material is contained in the equipment.

A-2. AVERAGE EMISSION FACTOR APPROACH

The Average Emission Factor Approach is demonstrated for Streams A and B, which contain light liquid pumps. The SOCFI average TOC emission factor for light liquid pumps is 0.0199 kg/hr. Based on this emission factor and data contained in table A-1, total VOC emissions can be calculated. Note that the TOC's in Stream A are also VOC's and that stream A contains water, which is not a VOC. This is accounted for when total VOC emissions are estimated from Stream A. Table A-2 summarizes the Average Emission Factor Approach calculations.

A-3. SCREENING RANGES APPROACH

The Screening Ranges Approach is demonstrated for Streams A and B. The calculations for the Screening Ranges Approach are similar to those used for the Average Emission Factor Approach, except that an emission factor for each screening value range is used. In this example, the component screening values are designated as either less than 10,000 ppmv or equal to or greater than 10,000 ppmv. It is assumed that none of the light liquid pumps in Stream A have a screening value greater than or equal to 10,000 ppmv, and one of the light liquid pumps in Stream B screens greater than 10,000 ppmv. It is also assumed that one of the pumps in Stream B could not be screened. Emissions from this pump are calculated using the average emission factor. Table A-3 summarizes the calculations used in the Screening Ranges Approach.

A-4. EPA CORRELATION EQUATION APPROACH

The EPA Correlation Equation Approach is demonstrated for Streams A and B. The EPA Correlation Equation Approach involves entering screening values into a correlation equation to generate an emission rate for each equipment piece. In table A-4, assumed screening values and the resulting emissions for each individual equipment piece are presented. Emissions from the pump that was not screened are estimated using the average emission factor.

TABLE A-2. AVERAGE EMISSION FACTOR METHOD

Stream ID	Equipment count	TOC Emission factor (kg/hr/source)	Weight Fraction of TOC	Hours of operation (hr/yr)	VOC emissions ^a (kg/yr)
A	15	0.0199	0.80	8,760	2,090
B	12	0.0199	1.00	4,380	1,050
Total Emissions					3,140

^aVOC Emissions = (no. of components) × (emission factor) × (wt. fraction TOC) × (WP_{VOC}/WP_{TOC}) × (hours of operation).

TABLE A-3. SCREENING VALUE RANGES METHOD

Stream ID	Equipment count	TOC Emission factor (kg/hr/source)	Hours of operation (hr/yr)	VOC emissions (kg/yr)
Components screening $\geq 10,000$ ppmv ^a				
B	1	0.243	4,380	1,060
Components screening $< 10,000$ ppmv ^a				
A	15	0.00187	8,760	246
B	10	0.00187	4,380	82
Components not screened ^b				
B (TOC wt. fraction equal to 1.0)	1	0.0199	4,380	87
Total emissions				1,480

A-5
^aVOC emissions = (no. of components) × (TOC emission factor) × (WP_{VOC}/WP_{TOC}) × (hours of operation).

^bVOC emissions = (no. of components) × (average TOC emission factor) × (wt. fraction of TOC) × (WP_{VOC}/WP_{TOC}) × (hours of operation).

TABLE A-4. EPA CORRELATION EQUATION METHOD^a

Equipment ID	Screening value (ppmv)	TOC mass emissions ^b (kg/yr)
A-1	0	0.066
A-2	0	0.066
A-3	0	0.066
A-4	0	0.066
A-5	0	0.066
A-6	20	2.0
A-7	50	4.2
A-8	50	4.2
A-9	100	7.4
A-10	100	7.4
A-11	200	13
A-12	400	23
A-13	1,000	49
A-14	2,000	87
A-15	5,000	190
Total Stream A Emissions:		390
B-1	0	0.033
B-2	0	0.033
B-3	0	0.033
B-4	10	0.55
B-5	30	1.4
B-6	250	7.9
B-7	500	14
B-8	2,000	44
B-9	5,000	93
B-10	8,000	140
B-11	25,000	350
B-12 (100% TOC)	Not screened	87
Total Stream B Emissions:		740
Total Emissions		1,130

^aEquipment type: Light liquid pumps.

Correlation equation: Leak rate (kg/hr) = $1.90 \times 10^{-5} \times (SV)^{0.824}$

Default-zero mass emission rate: 7.49×10^{-6} kg/hr

Hours of operation: Stream A = 8,760; Stream B = 4,380.

^bVOC Emissions = (correlation equation or default-zero emission rate) \times (WP_{VOC}/WP_{TOC}) \times (hours of operation)

^cVOC Emissions = (average emission factor) \times (wt. fraction of TOC) \times (WP_{VOC}/WP_{TOC}) \times (hours of operation)

A-5. UNIT-SPECIFIC CORRELATION APPROACH

Correlation equations may be developed for specific units rather than using the more general EPA Correlation Equations. Appendix B presents details on developing unit-specific correlations. Once correlations are developed using the approach outlined in appendix B, they are applied in the same manner as described for the EPA correlations.

A-6. SPECIATING EMISSIONS

The emission rate of specific compounds in a mixture can be calculated if the concentration of the compound in the stream is known. The equation for speciating emissions is

$$E_x = E_{\text{TOC}} \times (WP_x/WP_{\text{TOC}})$$

where:

E_x	=	The mass emissions of organic chemical "x" from the equipment piece (mass/time);
E_{TOC}	=	The TOC mass emissions from the individual equipment piece (mass/time) calculated from either the Average Emission Factor, Screening Ranges, Correlation, or Unit-Specific Correlation approaches;
WP_x	=	The concentration of organic chemical "x" in the equipment piece (weight percent);
WP_{TOC}	=	The total TOC concentration in the equipment piece (weight percent).

See table A-5 for a demonstration of speciating emissions of Stream B. Because all of the equipment in Stream B contains the same composition, the emissions can be speciated on a stream-wide basis.

A-7. RESPONSE FACTORS

Response factors are used to correct screening values to compensate for variations in a monitor's response to different compounds. Determination of whether an adjustment to the screening value will provide more valid emission estimates can be made by reviewing RF's at actual concentrations of 500 ppmv and 10,000 ppmv for the material in the equipment being screened.

TABLE A-5. SPECIATING EMISSIONS OF STREAM B^a

Method of calculation	Total TOC emission (kg/yr)	Ethyl acrylate emissions ^b (kg/yr)	Styrene emissions ^b (kg/yr)
Avg. emission factor	1,050 ^c	105	945
Screening ranges	1,230 ^d	123	1,110
Correlation equation	740 ^e	74	666

^aEquipment type: Light liquid pumps
 Total TOC wt. fraction 1.0
 Ethyl acrylate wt. fraction 0.1
 Styrene wt. fraction 0.9

^bEmissions for species = (total TOC emissions) × (wt. fraction of individual chemical)/(total TOC wt. fraction).

^cFrom Table A-2.

^dFrom Table A-3.

^eFrom Table A-4.

The RF's can be taken from table D-1 in appendix D, or may be calculated based on analytical measurement performed in a laboratory. For materials with RF's below three at both actual concentrations, the screening value does not need to be corrected. If the RF at either concentration is above three, the screening value obtained from the monitoring device should be adjusted.

If it is necessary to adjust the screening value, one of two approaches can be applied:

- (1) Use the higher of either the 500 ppmv or 10,000 ppmv RF to adjust all screening values, or
- (2) Plot the RF versus screening value and determine the applicable RF for each screening value.

Table D-1 in appendix D presents the RF's for chemical compounds at actual concentrations of 500 ppmv and 10,000 ppmv for several different monitoring devices. For the example calculations presented here, data for the Foxboro OVA-108 is utilized. Table A-6 presents the RF's for ethyl acrylate and styrene. From table A-6, it can be seen that at both concentrations, the RF for ethyl acrylate is below three. Therefore, it is not necessary to adjust any of the screening values taken from the equipment in Stream A. (The only TOC constituent in Stream A is ethyl acrylate.) Stream B contains 10 percent ethyl acrylate and 90 percent styrene. The RF's at both concentration values for Stream B are calculated using the following equation:

$$RF_m = \frac{1}{\sum_{i=1}^n (X_i / RF_i)}$$

where:

RF_m = Response factor of the mixture;

n = Number of constituents in the mixture;

X_i = Mole fraction of constituent i in the mixture; and

TABLE A-6. APPLICATION OF RESPONSE FACTORS^a

Chemical	Molecular weight	Mole fraction for stream B ^b	Response factor at actual conc. of 500 ppmv	Response factor at actual conc. of 10,000 ppmv
Ethyl Acrylate (0.10 wt. frac.)	100.1	0.1036	2.49	0.72
Styrene (0.90 wt. frac.)	104.2	0.8964	1.10	6.06

^aResponse factors are taken from Table D-1 in Appendix D and are based on a Foxboro OVA-108 calibrated with methane.

^bMole fraction calculated as:

A-10

$$= \frac{\text{Weight fraction compound } i}{\text{MW of compound } i} \bigg/ \sum_{i=1}^n \frac{\text{Weight fraction compound } i}{\text{MW of compound } i}$$

RF_i = Response factor of constituent i in the mixture;

The derivation of the above equation is presented in table A-7. Using the RF's and mole fraction information from table A-6, the RF for the mixture in Stream B is calculated as follows:

$$RF_m(@ 500 \text{ ppmv}) = (0.1036/2.49 + 0.8963/1.10)^{-1} = 1.17$$

and

$$RF_m(@ 10,000 \text{ ppmv}) = (0.1036/0.72 + 0.8964/6.06)^{-1} = 3.43$$

From the above calculations, it can be seen that at an actual concentration of 10,000 ppmv the RF is above three, which means the screening values need to be adjusted. Table A-8 demonstrates the simplest approach for adjusting the screening values. This approach involves multiplying all of the screening values by whichever RF is higher.

Correcting the screening values by the approach described above may be inaccurate in some cases. For example, if all or most of the equipment have low screening values, using the RF based on an actual concentration of 10,000 ppmv may cause an over estimate in the calculated emission rate. A more precise application of RF's is to plot the RF versus the screening value. This can be done by fitting a straight line between the RF and the corresponding screening values associated with the 500 and 10,000 ppmv actual concentrations. For the example case, this is done as follows.

Screening value associated with actual concentration of 500 ppmv:

$$= (500 \text{ ppmv}) / (RF \text{ at actual concentration of } 500 \text{ ppmv})$$

$$= 500 \text{ ppmv} / 1.17$$

$$= 427 \text{ ppmv}$$

Screening value associated with actual concentration of
10,000 ppmv:

$$= \frac{(10,000 \text{ ppmv})}{(\text{RF at actual concentration of } 10,000 \text{ ppmv})}$$

TABLE A-8. APPLYING RESPONSE FACTORS FROM TABLE C-1a

Equipment ID	Unadjusted screening value (ppmv)	Response factor of mixture	Adjusted screening value ^b (ppmv)	VOC Emission rate ^c (kg/yr)
B-1	0	--	Default zero	0.033
B-2	0	--	Default zero	0.033
B-3	0	--	Default zero	0.033
B-4	10	3.43	34	1.5
B-5	30	3.43	103	3.8
B-6	250	3.43	858	22
B-7	500	3.43	1,715	39
B-8	2,000	3.43	6,860	120
B-9	5,000	3.43	17,150	260
B-10	8,000	3.43	27,440	380
B-11	25,000	3.43	85,750	970
B-12	Not Screened	--	--	87 ^d
Total Emissions of Stream B				1,880

^aEquipment type: Light liquid pumps
 Correlation equation: Leak rate (kg/hr) = $1.90 \times 10^{-5} (SV)^{0.824}$
 Default-zero mass emission rate: 7.49×10^{-6} kg/hr
 Hours of operation: Stream B = 4,380

^bAdjusted SV = (unadjusted SV) × (RF of mixture)

^cVOC Emission = (correlation equation or default-zero emission rate) × (WP_{VOC}/WP_{TOC}) × (hours of operation)

^dVOC Emission = (average emission factor) × (wt. fraction of VOC) × (WP_{VOC}/WP_{TOC}) × (hours of operation)

TABLE A-7. DERIVATION OF EQUATION USED TO ESTIMATE RESPONSE FACTOR FOR A MIXTURE

- (1) Response Factor (RF) Equation:

$$RF = \frac{\text{Actual Concentration (ppmv)}}{\text{Screening Value (ppmv)}} = \frac{A}{SV}$$

- (2) For a mixture, each compound will contribute to the actual concentration and to the screening value, thus:

$$A = A_1 + A_2 + A_3 \dots = A_{TOT}$$

$$SV = SV_1 + SV_2 + SV_3 \dots$$

Thus, the above equation converts to:

$$RF = \frac{A_{TOT}}{SV_1 + SV_2 + SV_3 \dots}$$

- (3) The value for the screening value of each individual compound (SV_i) is calculated as:

$$SV_i = \frac{A_i}{RF_i}; \text{ substituting gives:}$$

$$RF = \frac{A_{TOT}}{\frac{A_1}{RF_1} + \frac{A_2}{RF_2} + \frac{A_3}{RF_3} \dots}$$

- (4) The mole fraction of each individual compound (X_i) is calculated as:

$$X_i = \frac{A_i}{A_{TOT}};$$

Thus, the actual concentration of compound i is calculated as:

$$A_i = X_i A_{TOT}; \text{ substituting gives:}$$

$$RF = \frac{A_{TOT}}{\frac{X_1 A_{TOT}}{RF_1} + \frac{X_2 A_{TOT}}{RF_2} + \frac{X_3 A_{TOT}}{RF_3} \dots} = \frac{1}{\frac{X_1}{RF_1} + \frac{X_2}{RF_2} + \frac{X_3}{RF_3} \dots}$$

- (5) Thus, the response factor of a mixture is calculated as:

$$RF = \frac{1}{\sum_{i=1}^n X_i / RF_i}$$

$$\begin{aligned} &= 10,000/3.43 \\ &= 2,915 \text{ ppmv} \end{aligned}$$

Figure A-1 plots this screening value/RF relationship. Table A-9 uses this plot to calculate emissions. Note that in table A-9, all of the screening values are adjusted. An alternative would be to adjust only those screening values having an associated RF greater than three. Note that for all screening values less than 427 ppmv, the RF calculated at 427 ppmv is applied, and, similarly, for all screening values above 2,915 ppmv, the RF at 2,915 ppmv is applied.

An alternative to using the RF's in appendix D is to use the analytical technique described in chapter 3.0 to determine RF's at several different actual concentrations. These RF's are then related to the screening value. Once the RF's and associated screening values are determined, a first-order or second-order (if the relationship appears nonlinear) equation can be fitted to the RF data. Table A-10 demonstrates how the collected data of RF's at actual concentrations is converted to RF's for the associated screening values. A hypothetical plot of the RF/screening value relationship is shown in figure A-2. Table A-11 demonstrates how emissions can then be calculated by applying the plot. Note that the line is not extrapolated beyond the highest screening value for which data were obtained.

A-8. ANNUALIZING EMISSIONS

If more than one screening value is obtained from an equipment piece, all of the screening values can be used to estimate emissions, as long as the elapsed time between each screening value obtained is known. This is demonstrated for pump A-15 in Stream A. Table A-12 shows how emissions are calculated for each period between the collection of screening values. Notice that each screening value is used to estimate emissions since the last screening value was obtained.

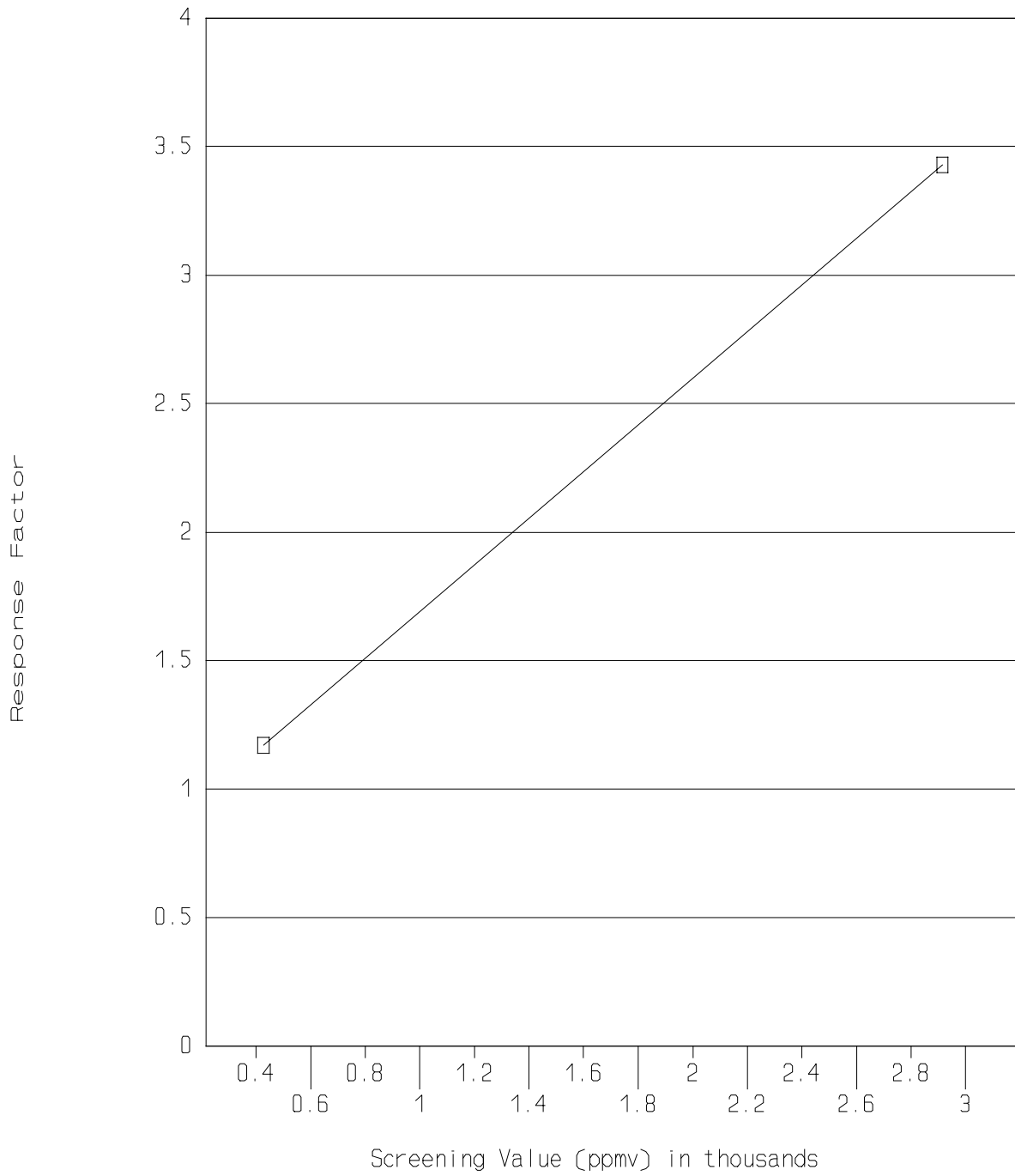

Figure A-1. Response Factor Curve Generated From Response Factor Data in Table C-1

TABLE A-9. ESTIMATING EMISSIONS USING RESPONSE FACTORS GENERATED FROM FIGURE A-1^a

Equipment ID	Unadjusted screening value (ppmv)	Response factor of mixture	Adjusted screening value ^b (ppmv)	VOC Emission rate ^c (kg/yr)
B-1	0	--	Default zero	0.033
B-2	0	--	Default zero	0.033
B-3	0	--	Default zero	0.033
B-4	10	1.17	12	0.63
B-5	30	1.17	35	1.6
B-6	250	1.17	293	9.0
B-7	500	1.24	620	17
B-8	2000	2.62	5,240	97
B-9	5000	3.43	17,150	260
B-10	8000	3.43	27,440	380
B-11	25000	3.43	85,750	970
B-12	Not screened	--	--	87 ^d
Total Emissions of Stream B				1,820

^aEquipment type: Light liquid pumps
 Correlation equation: Leak rate (kg/hr) = $1.90 \times 10^{-5} (SV)^{0.824}$
 Default-zero mass emission rate: 7.49×10^{-6} kg/hr
 Hours of operation: Stream B = 4,380

^bAdjusted SV = (unadjusted SV) × (RF of mixture taken from Figure A-1)

^cVOC Emission = (correlation equation or default-zero emission rate) × (WP_{VOC}/WP_{TOC}) × (hours of operation)

^dVOC Emission = (no. of components) × (average emission factor) × (wt. fraction of VOC) × (WP_{VOC}/WP_{TOC}) × (hours of operation)

A-17

TABLE A-10. GENERATION OF HYPOTHETICAL RESPONSE FACTOR DATA FOR STREAM B^a

Actual standard gas concentration (ppmv)	Sample number	Measured screening value (ppmv)	Response factor
500	1	375	1.33
500	2	390	1.28
500	3	<u>390</u>	<u>1.28</u>
		Avg = 385	Avg = 1.30
2,000	1	1,219	1.64
2,000	2	1,205	1.66
2,000	3	<u>1,258</u>	<u>1.59</u>
		Avg = 1,227	Avg = 1.63
5,000	1	1,865	2.68
5,000	2	1,930	2.59
5,000	3	<u>1,872</u>	<u>2.67</u>
		Avg = 1,889	Avg = 2.65
10,000	1	2,976	3.36
10,000	2	3,040	3.29
10,000	3	<u>2,994</u>	<u>3.34</u>
		Avg = 3,003	Avg = 3.33
25,000	1	6,361	3.93
25,000	2	6,394	3.91
25,000	3	<u>6,476</u>	<u>3.86</u>
		Avg = 6,410	Avg = 3.90

^aThis table is a demonstration of how analytical determination of response factors can be used to generate a response factor/screening value relationship.

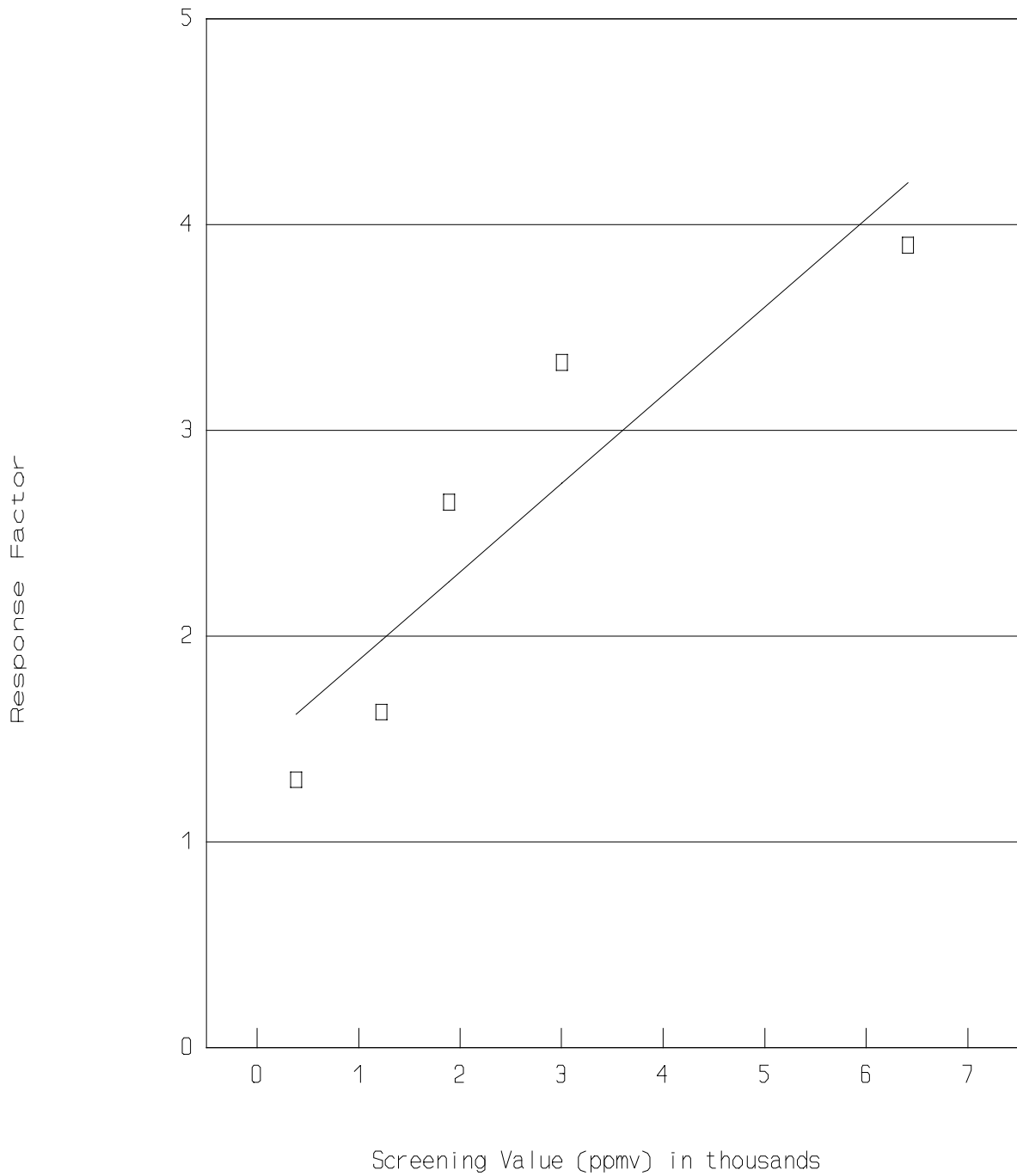

Figure A-2. Response Factor Curve Generated by Analytical Determination of Response Factors

TABLE A-11. RESPONSE FACTORS GENERATED FROM FIGURE A-2^a

Equipment ID	Unadjusted screening value (ppmv)	Response factor of mixture	Adjusted screening value ^b (ppmv)	VOC Emission rate ^c (kg/yr)
B-1	0	--	Default zero	0.033
B-2	0	--	Default zero	0.033
B-3	0	--	Default zero	0.033
B-4	10	1.46	15	0.76
B-5	30	1.47	44	1.9
B-6	250	1.56	390	11
B-7	500	1.69	845	21
B-8	2,000	2.31	4,620	87
B-9	5,000	3.60	18,000	270
B-10	8,000	4.20	33,600	450
B-11	25,000	4.20	105,000	1,140
B-12	Not screened	--	--	87 ^d
Total Emissions of Stream B				2,070

A-20

^aEquipment type: Light liquid pumps
 Correlation equation: Leak rate (kg/hr) = $1.90 \times 10^{-5} (SV)^{0.824}$
 Default-zero mass emission rate: 7.49×10^{-6} kg/hr
 Hours of operation: Stream B = 4,380

^bAdjusted SV = (unadjusted SV) × (RF of mixture taken from Figure A-2).

^cVOC Emissions = (correlation equation or default-zero emission rate) × (WP_{VOC}/WP_{TOC}) × (hours of operation).

^dVOC Emission = (no. of components) × (average emission factor) × (wt. fraction of VOC) × (WP_{VOC}/WP_{TOC}) × (hours of operation).

TABLE A-12. ANNUALIZING EMISSIONS FOR LIGHT LIQUID PUMP A-15a

Hypothetical date	Screening value (ppmv)	Hours elapsed since last screening value ^b	VOC emissions since last screening value ^c (kg)
January 1	5,000	--	--
February 1	0	744	0.006
March 1	0	672	0.005
April 1	8,000	744	23.3
May 1	100	720	0.6
June 1	1,000	744	4.2
July 1	0	720	0.005
August 1	0	744	0.006
September 1	0	744	0.006
October 1	10,000	720	27.0
November 1	0	744	0.006
December 1	0	720	0.005
January 1	0	744	0.006
TOTALS:		8,760	55.1

^aEquipment type: Light liquid pumps
 Correlation equation: Leak rate (kg/hr) = $1.90 \times 10^{-5} (SV)^{0.824}$
 Default-zero mass emission rate: 7.49×10^{-6} kg/hr

^bHours elapsed since the last screening value was obtained. For example, the hours elapsed since the screening value obtained on March 1 are the hours from February 1 to March 1, which equal 24 hr/day \times 28 days, or 672 hours.

^cVOC Emissions = (correlation equation or default-zero emission rate) \times (WP_{VOC}/WP_{TOC}) \times (hours elapsed).

A-9. ESTIMATING VOC EMISSIONS FROM EQUIPMENT CONTAINING ORGANIC COMPOUNDS NOT CLASSIFIED AS VOC'S.

Stream C contains ethane, which is an organic compound, but is not classified as a VOC. When a monitoring instrument is used to screen equipment in Stream C, the resulting screening value will include measurement of the ethane. However, the ethane should not be included in the estimated VOC emission rate. The following equation is applied to subtract out the ethane contribution:

$$E_{VOC} = E_{TOC} \times (WP_{VOC}/WP_{TOC})$$

where:

- E_{VOC} = The VOC mass emissions from the equipment (kg/hr);
- E_{TOC} = The TOC mass emissions from the equipment (kg/hr); calculated from either the Average Emission Factor, Screening Ranges, Correlation, or Unit-Specific Correlation approaches;
- WP_{VOC} = The concentration of VOC in the equipment in weight percent;
- WP_{TOC} = The TOC concentration in the equipment in weight percent.

The above calculation is demonstrated below by assuming that screening values have been obtained from equipment in Stream C as either greater than or equal to 10,000 ppmv or less than 10,000 ppmv. Assume 2 of the 40 gas valves in Stream C screened above 10,000 ppmv, and the remainder screened below 10,000 ppmv. Uncorrected VOC emissions are calculated using the Screening Ranges Approach:

$$E_{TOC} = (F_G \times N_G) + (F_L \times N_L)$$

where:

- E_{TOC} = TOC emission rate for an equipment type (kg/hr);
- F_G = Applicable emission factor for sources with screening values greater than or equal to 10,000 ppmv (kg/hr/source);

- N_G = Equipment count (specific equipment type) for sources with screening values greater than or equal to 10,000 ppmv;
 F_L = Applicable emission factor for sources with screening values less than 10,000 ppmv (kg/hr/source); and
 N_L = Equipment count (specific equipment type) for sources with screening values less than 10,000 ppmv.

Thus,

$$\begin{aligned}
 E_{TOC} &= 0.0782 \text{ kg/hr} \times 2 + 0.000131 \text{ kg/hr} \times 38 \\
 &= 0.161 \text{ kg/hr}
 \end{aligned}$$

Converting to an annual emission rate gives:

$$\begin{aligned}
 &= 0.161 \text{ kg/hr} \times 8,760 \text{ hr/yr} \\
 &= 1,410 \text{ kg/yr}
 \end{aligned}$$

Using the weight fraction of the compounds in Stream C given in table A-1 (65% ethyl acrylate, 25% ethane, and 10% water vapor), the above emission rate is corrected as follows:

$$\begin{aligned}
 E_{VOC} &= E_{TOC} \times (WP_{VOC}/WP_{TOC}) \\
 &= 1,410 \text{ kg/yr} \times 65/(65 + 25) \\
 &= 1,020 \text{ kg/yr VOC emissions}
 \end{aligned}$$

A-10. ESTIMATING INORGANIC EQUIPMENT LEAKS

If the hypothetical process unit also had equipment that contained a volatile inorganic compound, emissions could be estimated using the following guidelines. If a monitoring device is not available, the equipment emissions can be calculated using the Average Emission Factor Approach. If a monitoring device is available, the best approach for estimating the emissions is to generate unit specific correlations, but the EPA Correlation Equations could also be applied as in section A-4. If the monitoring device cannot accurately predict the screening value

but can be used to predict concentrations greater than/less than 10,000 ppmv, the emissions may be estimated by applying the Screening Ranges approach presented in section A-3.

APPENDIX B:

LEAK RATE/SCREENING VALUE CORRELATION DEVELOPMENT
AND REVISION OF SOCM I CORRELATIONS
AND EMISSION FACTORS

APPENDIX B

The purpose of this appendix is to provide supplemental information on the approach for developing site-specific correlations as discussed in chapter 2.0 of this document. Also, this appendix contains background information on the data collection and analysis performed to revise the SOCFI correlations and emission factors, and presents summary parameters associated with the SOCFI and petroleum industry correlations. Section B.1 addresses the following:

- Analysis of bagging and screening data;
- Development of a correlation equation; and
- Development of a default-zero leak rate.

Section B.2 addresses the following:

- Analysis of new SOCFI bagging data;
- Development of revised correlations and default-zero leak rates;
- Development of revised SOCFI emission factors; and
- Summary of SOCFI and petroleum industry correlation parameters.

B.1 DEVELOPMENT OF SITE-SPECIFIC CORRELATION EQUATIONS

Development of site-specific correlations involves bagging individual pieces of equipment. (Refer to chapter 4.0 for details on how equipment is bagged.) The emission rate and associated screening value from several equipment pieces of the same type (valve, pump, connector, etc.) and service (gas, light liquid or heavy liquid) are used to develop a correlation. The correlation predicts a leak rate based on a screening value. To develop a correlation, "bagging data" must be collected. In this appendix, "bagging data" refers to data used to estimate the mass emission rate from an equipment piece, and the screening value obtained with the portable monitoring instrument when the equipment piece is bagged.

B.1.1 Preliminary Analysis of Bagging Data.

For the purposes of this discussion, it is assumed the blow-through method is used to bag the equipment piece. For each

bagged (tented) equipment piece, two sample bags should be collected. For each sample bag the following bagging data should be recorded: (1) total organic compound concentration (ppmv) measured in the sample bag at the laboratory using a GC or similar instrument, (2) the mole percent and molecular weight of each of the constituents in the sample bag (or alternatively in the process stream contained within the enclosed equipment piece), (3) the temperature in the tent when the sample bag is collected, (4) the carrier gas flow rate out of the tent, (5) the tent oxygen concentration (6) background bag organic compound concentration measured at the laboratory (optional), and (7) the density and volume of any organic liquid collected from the bagged equipment piece and the time in which the liquid accumulated.

In some cases, the sample bag total organic concentration will be below the GC minimum detection limit. If this occurs, one half the GC minimum detection limit should be used to estimate emissions.

For each sample bag, the vapor leak rate is calculated using the following equation:

$$\text{Vapor leak rate (kg/hr)} = \frac{(1.219 \times 10^{-5}) \times (Q) \times (MW) \times (GC)}{T + 273.15}$$

where:

1.219×10^{-5} = A conversion factor based on the gas constant and assuming a pressure in the tent of 1 atmosphere ($^{\circ}\text{K} \times 10^6 \times \text{kg-mol/m}^3$)

Q = Flow rate out of tent (m^3/hr)

$$= \frac{\text{N}_2 \text{ flow rate (l/min)}}{1 - [\text{tent oxygen conc. (volume \%)/21]} \times \frac{0.06 \text{ m}^3/\text{min}}{\text{l/hr}}$$

T = Temperature in tent ($^{\circ}\text{C}$)

MW = Molecular weight of organic compounds in the sample bag or alternatively in the process stream contained within the equipment piece being bagged. For mixtures, MW is calculated as follows:

$$MW = \frac{\sum_{i=1}^n MW_i x_i}{\sum_{i=1}^n x_i}$$

where:

- MW_i = Molecular weight of organic compound i;
- x_i = Mole fraction of organic compound i; and
- n = Number of organic compounds in the mixture.

GC = Sample bag organic compound concentration. If a background sample bag is obtained, the value of GC can be corrected for background organic compound concentration using the following equation:

$$GC = SBC - \left(\frac{Oxy \times BBC}{21} \right)$$

where:

- SBC = Sample bag organic compound concentration (ppmv);
- Oxy = Tent oxygen concentration (volume %); and
- BBC = Background sample bag organic compound concentration.

The vapor leak rate calculated from the two sample bags is averaged. Added to this average vapor leak rate is the leak rate of any liquid that is collected in the bag. The liquid leak rate is calculated as follows:

$$\text{Liquid leak rate (kg/hr)} = \frac{\rho V_L}{16.67 t}$$

where:

- ρ = Density of organic liquid collected (g/ml);
- V_L = Volume of organic liquid collected (ml);
- t = Time in which liquid is collected (minutes); and
- 16.67 = A conversion factor to adjust term to units of kilograms per hour [g × hr/(kg × min)]

Thus, the total emission rate for the bagged equipment piece is as follows:

$$\text{Leak rate (kg/hr)} = \text{Average vapor leak rate (kg/hr)} + \text{Liquid leak rate (kg/hr)}$$

The screening value associated with each bagged equipment piece is calculated by subtracting the background screening value from the average of the initial and final screening values. In cases where the background concentration was larger than the average of the initial and final screening values, the screening value should be recorded as 0 ppmv.

B.1.2 Correlation Equation Development.

After preliminary analysis of the bagging data is complete, there will be a mass emission rate and corresponding screening value associated with each individual equipment piece that was bagged. All mass emission rate/screening value data pairs with nonzero screening values are used to develop the site-specific correlation. Data pairs with a screening value of zero can be used to develop a default-zero leak rate, and this is discussed in section B.1.3.

Two terms used in conjunction with developing the correlation are defined as follows: "log space"--where the logarithms of both the screening values and mass emission rates are evaluated, and "arithmetic space"--where the actual screening values and emission rates are evaluated. The data is first analyzed in log space to develop an expression relating the logarithm of the screening value to the logarithm of the mass

emission rate. This expression is then transformed to arithmetic space to arrive at the correlation equation.

It is necessary to perform the initial analysis in log space because both the screening value and mass emission rate data typically span several orders of magnitude, and the data are not normally distributed in arithmetic space. Normality of the data is important for the validity of the statistical procedures being used. Historically, the data have been shown to be approximately log-normally distributed.

The first step in the development of the correlation equation is to calculate the logarithm of each screening value and mass emission rate. Note that the correlation developed will be the same whether the natural logarithm or base 10 logarithm is used. The next step is to perform simple linear (least squares) regression in log space. The log of the mass emission rate (dependent variable, Y) is regressed on the log of the screening value (independent variable, X). The resulting regression line takes the following form:

$$Y_i = \beta_0 + \beta_1 X_i$$

where:

Y_i = Logarithm of the leak rate determined by bagging equipment piece i ;

X_i = Logarithm of the screening value for equipment piece i ;

β_0 = Intercept of regression line; and

β_1 = Slope of regression line.

The value for the slope and intercept are calculated using the following equations:

$$\beta_1 = \frac{(\overline{XY}) - (\overline{X})(\overline{Y})}{\overline{X^2} - (\overline{X})^2}$$

and

$$\beta_0 = \bar{Y} - \beta_1 \bar{X}$$

where:

$$\bar{X} = \frac{\sum X_i}{n}$$

$$\bar{Y} = \frac{\sum Y_i}{n}$$

$$\overline{XY} = \frac{\sum X_i Y_i}{n}$$

$$\overline{X^2} = \frac{\sum X_i^2}{n}$$

n = number of screening/bagging pairs.

Once these have been calculated, then the Mean Squared Error (MSE) can be given by:

$$MSE = \frac{1}{n - 2} \sum_{i=1}^n r_i^2$$

where:

$$r_i = Y_i - \beta_0 - \beta_1 X_i$$

The slope and intercept and a scale bias correction factor (SBCF) are used in the final step to transform the regression equation from log space to arithmetic space. The transformed equation is the correlation equation and it is calculated as follows:

$$\text{Leak rate (kg/hr)} = \text{SBCF} \times (e \text{ or } 10)^{\beta_0} \times (\text{Screening value})^{\beta_1}$$

Note that if the natural logarithm of the leak rates and screening values is used when developing the regression line, then the "e" term should be raised to the power of the intercept

(β_0). On the other hand, if the base 10 logarithm of the leak rates and screening values is used when developing the regression line, then the "10" term should be raised to the power of the intercept (β_0).

The SBCF is a correction factor which accounts for the variability of the data in the log space (see discussion in section 2.3.4). It is obtained by summing a sufficient number (usually 10-15) of the terms from the infinite series given below:

$$\text{SBCF} = 1 + \frac{(m-1) \times T}{m} + \frac{(m-1)^3 \times T^2}{m^2 \times 2! \times (m+1)} + \frac{(m-1)^5 \times T^3}{m^3 \times 3! \times (m+1) \times (m+3)} + \dots,$$

where:

T (when regression performed using base 10 logarithms)
 $= (\text{MSE}/2) \times (\ln 10)^2$;

T (when regression performed using natural logarithms)
 $= (\text{MSE}/2)$;

MSE = mean square error from the regression;

ln10 = natural logarithm of 10; and

m = number of data pairs (n) - 1.

B.1.3 Determination of Default Zero and Pegged Mass Emission Rates

A default zero emission rate can be calculated based on the emission rates measured from bagged equipment that have a screening value of zero ppmv. A pegged emission rate can be calculated based on the emission rates measured from bagged equipment that have a screening value reported as pegged. The first step to determine the default-zero or pegged leak rate is to take the logarithm of each of the mass emission rates and then determine the average log leak rate. The average log leak rate is used to calculate the default-zero or pegged mass emission rate. Analysis is performed in log space rather than just determining the arithmetic average because this gives the most efficient estimator of the default-zero or pegged leak rate. The average log leak rate and a scale bias correction factor, that

takes into account the variance of the log mass emission rates, are then utilized in the following equation to calculate the default zero leak rate:

$$\text{Default Zero or pegged Leak Rate (kg/hr)} = \text{SBCF} \times (10 \text{ or } e)^{\text{LOG:AVG}}$$

where:

SBCF = Scale bias correction factor for the logs of the mass emission rates; and

LOG:AVG = Average of the logs of the mass emission rates.

The SBCF for the default zero or pegged leak rate determination is calculated using the same equation for the SBCF as presented in section B.1.2, with the following two exceptions: (1) the variance of the log mass emission rates is used in the "T" term, rather than the regression mean square error (MSE); and (2) the sample size (n) is used in the "m" term, rather than "n-1". The variance (S^2) of the log mass emission rates is calculated as:

$$S^2 = \frac{1}{n-1} \sum_{i=1}^n (\text{LOG:LEAK}_i - \text{LOG:AVG})^2$$

where:

LOG:LEAK_i = Logarithm of leak rate from component i;

LOG:AVG = Average of the logs of the mass emission rates; and

n = Number of data points.

B.2 DEVELOPMENT OF REVISED SOCFI CORRELATIONS AND FACTORS

In 1990 bagging data were obtained from several ethylene oxide (EO) and butadiene (BD) producers. Bagging data were collected from connectors, light liquid pumps, gas valves, and light liquid valves. In 1987 and 1988 screening data had been

collected from the same EO/BD process units. These bagging and screening data were used to revise the SOCFI correlations and factors.

(Note that as used in the following discussion, "bagging data" refers to the screening value/mass emission data pairs, and "screening data" to the data set of screening values collected independently of the bagging data. Normally, bagging data are collected from a chosen set of equipment pieces to provide the best data for developing a correlation. On the other hand, screening data are collected from all equipment pieces to give a representative distribution of screening values).

To revise the SOCFI correlations and factors, the data collected from the EO/BD process units were compared with data previously collected from SOCFI process units. In the following discussion this previously collected data are referred to as "old" data. The old SOCFI bagging data were collected in the Six-Unit Maintenance Study (EPA-600/S2-81-080). The old SOCFI screening data were collected in the 24-Unit Study (EPA-600/2-81-003). The EO/BD data are referred to as "new." When the data sets are joined, the resulting data set is referred to as "combined."

B.2.1 Analysis of SOCFI Bagging Data

Following the approach described in section B.1, the new SOCFI bagging data were analyzed to develop new correlations. A comparison of the old and new bagging data was performed to evaluate any differences. Note that for connectors, only new bagging data were analyzed since connectors were not bagged as part of the Six-Unit Maintenance Study. Attachment 1 includes the complete list of each of the emission rate/screening value datapoints and presents summary tables on the regression statistics of the old, new, and combined data.

To evaluate the differences between the new and the old data for light liquid pumps, light liquid valves, and gas valves, the following statistical tests were applied:

- Wilcoxon test of paired differences, and
- F-test of statistical parameters.

The statistical tests did not have consistent results for the three equipment types. For light liquid pumps, no statistically significant differences were found, for light liquid valves, the tests indicated significant differences, and for gas valves, the tests were inconclusive.

A better comparison was a visual comparison of the data plotted in log space. This comparison was made by developing plots of the old and new bagging data with regression lines superimposed. All of the regression equations are plotted in figures B-1 through B-4. Figure B-1 presents the new bagging data and regression equation for connectors. Figures B-2 through B-4 show old and new bagging data superimposed upon the old, new, and combined regression equations for light liquid pumps, gas valves, and light liquid valves, respectively. The regression lines in these four figures are drawn to correspond only to the data points from which they were derived.

Figures B-2 through B-4 suggest the old and new data points appear to lie along a common axis with a similar amount of scatter. Figures B-2 through B-4 also demonstrate that most of the old data were from equipment which had screening values exceeding 1,000 ppmv, whereas a significant portion of the new data came from equipment screening less than 1,000 ppmv. The correlation derived from combining the old and new bagging data spans the greatest range of screening values. Additionally, for each of the equipment types, the combined correlation equation has the best fit. Since the combined regressions span the greatest range of screening values and have the best fit, the combined data set was used to develop the revised SOCFI correlation equations.

B.2.2 Development of Revised SOCFI Correlations and Development of Default-Zero Factors.

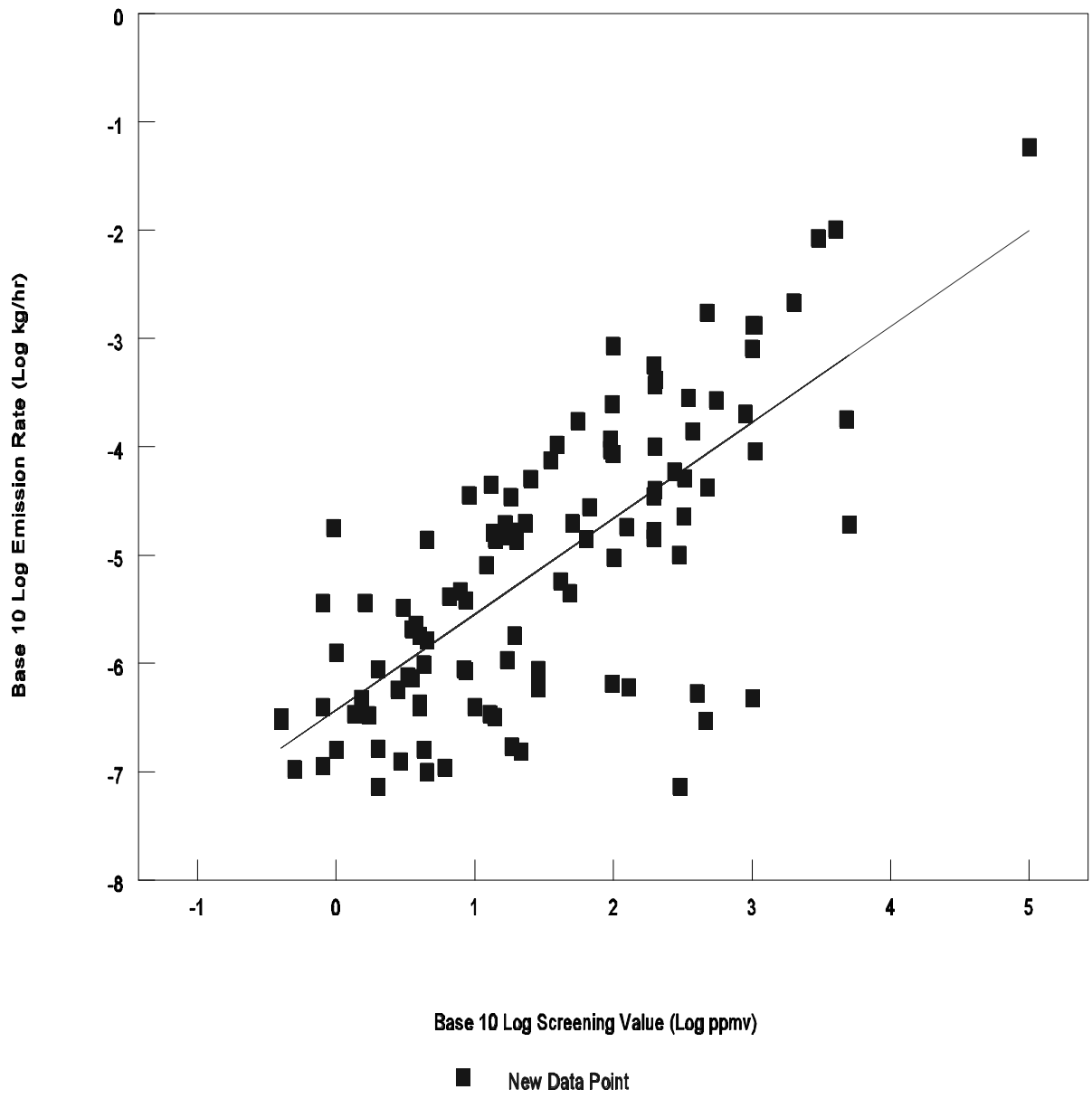

Figure B-1. Connector Regression Equation

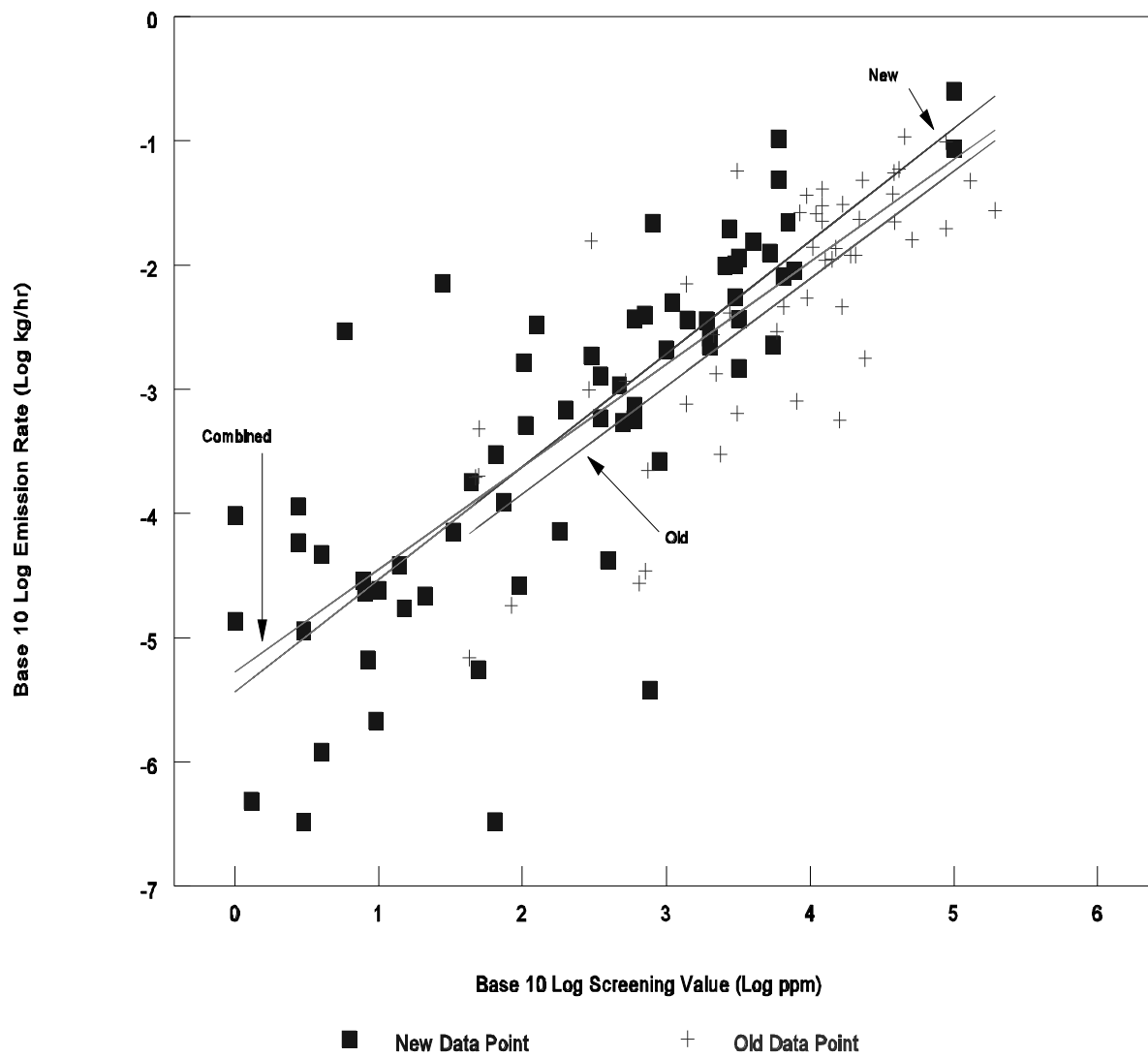

Figure B-2. Light Liquid Pump Regression Equations

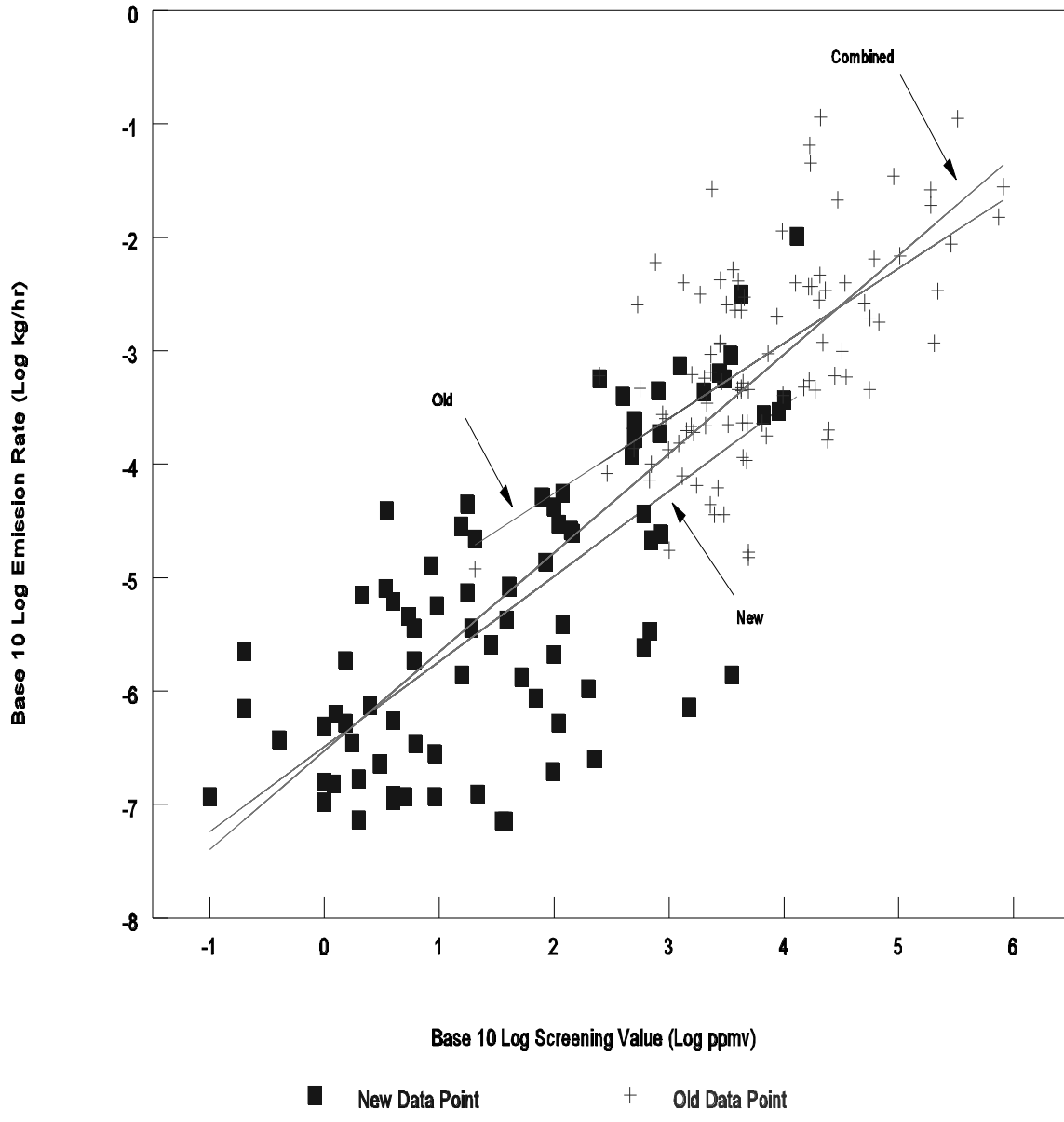

Figure B-3. Gas Valve Regression Equations

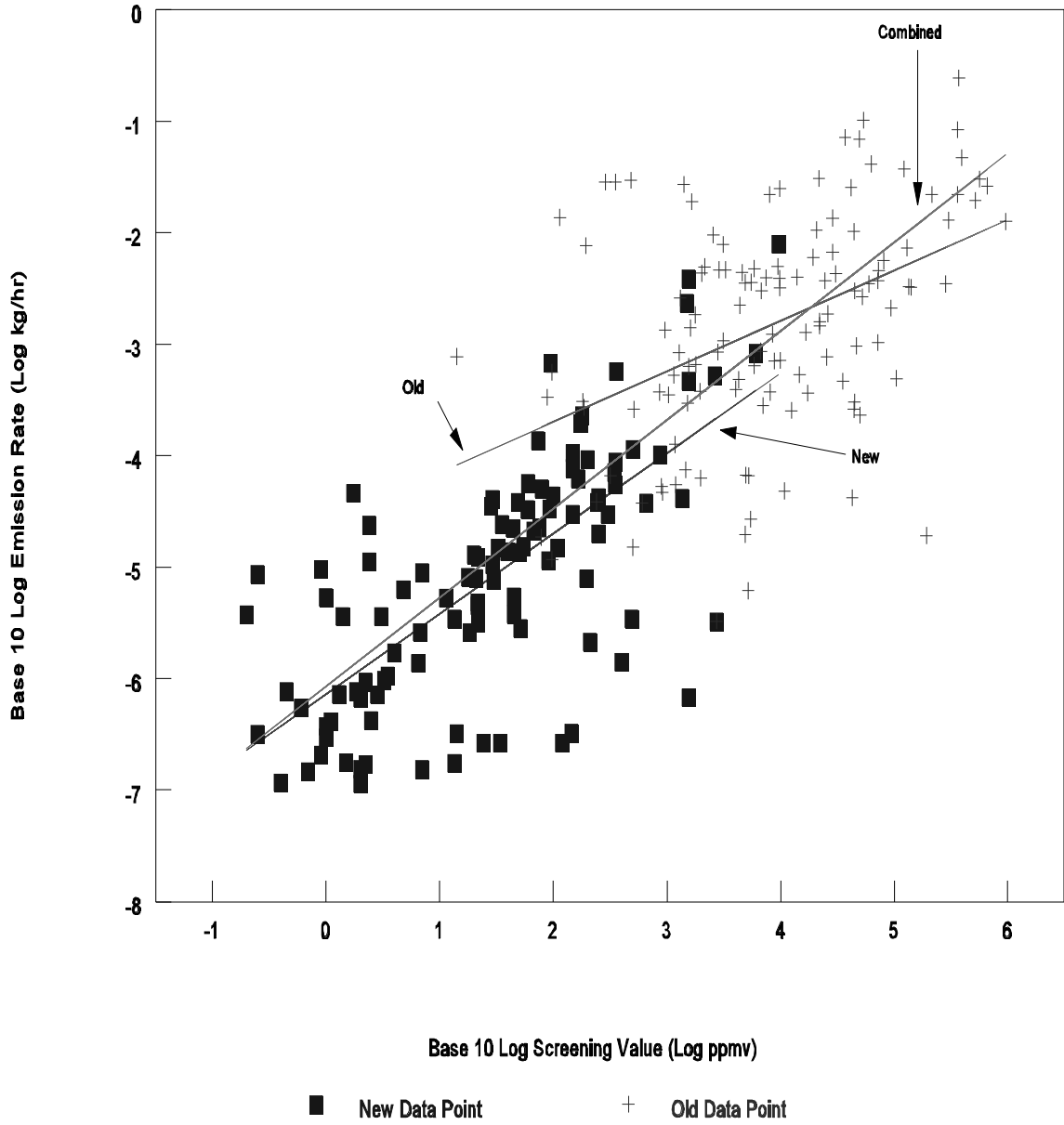

Figure B-4. Light Liquid Valve Regression Equations

After the old and new bagging data were combined, an initial regression analysis was performed on the logarithms of the screening values and mass emission rates following the procedures outlined in section B.1 on the development of correlation equations. For the combined data sets outliers were removed. The residuals (differences between measured log mass emission rates and log mass emission rates predicted by the regression) were used to flag outliers. A data pair was flagged as an outlier whenever the absolute value of its studentized residual (the residual divided by its standard error) was greater than or equal to 3. These data pairs are indicated as outliers in the table contained in attachment 1, which lists the screening values and mass emission rates for the combined bagging data set.

Attachment 2 contains a table listing all of the bagging data used to develop the default zero mass emission rates. These data were collected at the EO/BD process units, and were analyzed using the approach outlined in section B.1.3.

B.2.3 Revision of SOCFI Emission Factors

After the SOCFI correlations were revised, they were utilized in conjunction with the "old", "new", and "combined" screening value data sets to revise the SOCFI emission factors. Recall that the "old" screening data were the data collected in the SOCFI 24-Unit Study (EPA-600/2-81-003), the "new" screening data were the data collected from the EO/BD process units in 1987 and 1988, and the combined data were the two data sets combined.

Using screening data in conjunction with the applicable correlation equation, emission factors are calculated in the following manner.

- (1) Screening values with a value of zero are assigned the default zero emission rate,
- (2) Pegged screening values were assigned the appropriate pegged emission rate,
- (3) All other screening values are entered into the applicable correlation equation to determine the associated mass emission rate, and

- (4) The sum of all of the individual emission rates is divided by the total number of screening values (i.e., equipment pieces) to give the average factor.

These steps were followed to revise the SOCFI average emission factors for connectors, light liquid pumps, gas valves, and light liquid valves. The same approach was used to revise the SOCFI Screening Range Emission factors ($\geq 10,000$ ppmv / $< 10,000$ ppmv), except that the screening values were segregated into the two ranges to calculate the average of each range.

Consistent with development of the revised SOCFI correlation equations (which were developed from the combined bagging data set), the combined screening data set was used to revise the SOCFI factors. The combined data set has the advantage that it reflects changes that have occurred in SOCFI process units since the 24-Unit Study, and contains data from a representative sampling of SOCFI process units.

To develop the emission factors it was necessary to make adjustments to a small percentage of the screening values. These adjustments were applied to large screening values that were identified as "pegged data." The large screening value data are important in the emission factor calculations and these adjustments were made in an attempt to keep as many screening values in the analysis as possible.

Examination of the frequency distributions of the screening value data sets revealed spikes near 10,000 ppmv (between 9980 and 10,001 ppmv) and near 100,000 ppmv (between 99,980 and 100,001 ppmv). These spikes indicate that the instrument was "pegged" or unable to measure the concentration being sampled because the concentration was beyond the measurement range of the instrument. It was assumed that screening values pegged at 10,000 ppmv had actual values between 10,000 and 100,000 ppmv, and that screening values pegged at 100,000 ppmv had actual values greater than 100,000 ppmv. Because there were several screening values greater than 10,000 ppmv and 100,000 ppmv that were not pegged, an average from the two ranges

(10,000-100,000 ppmv and >100,000 ppmv) was calculated to substitute for the pegged readings. For the 10,000-100,000 ppmv range, the average was 33,620 ppm and for the greater than 100,000 ppmv range, the average was 302,367 ppm. These averages were used in the emission factor analysis for pegged data from the screening data sets. Thus, each pegged screening value was assigned the applicable average screening value, which was entered into the correlation to predict emissions.

Attachment 3 lists the average emission factors generated from each of the screening data sets, using the revised SOCFI correlations. There are thousands of screening values in the data sets, and these data sets are not reproduced in this appendix. Instead, figures plotting the distribution of the screening values are presented in attachment 3.

B.2.4 Summary of SOCFI and Petroleum Industry Correlation Parameters

Table B-1 presents the regression line slope and intercept and the SBCF associated with each of the revised SOCFI and petroleum industry correlations contained in tables 2-9 and 2-10 of this document.

TABLE B-1. SUMMARY OF SOCFI AND PETROLEUM INDUSTRY CORRELATION PARAMETERS.

Equipment type	Regression intercept ^a (β_0)	Regression slope (β_0)	SBCF
<u>SOCFI Correlations</u>			
Gas valves	-6.529	0.873	6.315
Light liquid valves	-6.069	0.797	7.520
Light liquid pumps	-5.273	0.824	3.563
Connectors	-6.434	0.885	8.298
<u>Petroleum Industry Correlation</u>			
Valves	-6.154	0.746	3.27
Pumps	-5.014	0.610	5.15
Others	-5.575	0.589	5.14
Connectors	-6.468	0.735	4.51
Flanges	-5.988	0.703	4.48
Open-Ended Lines	-6.366	0.704	5.11

^aRegression intercepts are based on analysis in log space using Base 10 logarithms of leak rates in kg/hr.

APPENDIX B: ATTACHMENT 1

This attachment lists bagging data used to develop the combined correlation equations for each of the equipment types in table B-1-1. Also included is a summary table (table B-1-2) of the regression statistics associated with the old, new, and combined SOCFI bagging data sets. Note that the regression statistics presented in table B-1-2 are based on development of the regression lines using natural log leak rates and natural log screening values.

Table B-1-1. Bagging data used to develop the combined correlation equations.

----- Equipment Type=CONNECTOR Service=ALL -----

Plant Type	Data Origin	Measured Emission Rate (kg/hr)	Screening Value (ppmv)	Natural Log of Emission Rate (kg/hr)	Natural Log of Screening Value (ppmv)
EO	NEW	0.0000000728	299.00	-16.4361	5.7004
EO	NEW	0.0000000734	2.00	-16.4271	0.6931
EO	NEW	0.0000001004	4.50	-16.1142	1.5041
EO	NEW	0.0000001061	0.50	-16.0586	-0.6931
EO	NEW	0.0000001101	6.00	-16.0217	1.7918
EO	NEW	0.0000001137	0.80	-15.9900	-0.2231
BD	NEW	0.0000001265	2.90	-15.8832	1.0647
EO	NEW	0.0000001544	21.50	-15.6835	3.0681
EO	NEW	0.0000001613	4.25	-15.6400	1.4469
BD	NEW	0.0000001620	1.00	-15.6354	0.0000
EO	NEW	0.0000001644	2.00	-15.6207	0.6931
EO	NEW	0.0000001731	18.50	-15.5693	2.9178
EO	NEW	0.0000002953	458.50	-15.0354	6.1280
EO	NEW	0.0000002996	0.40	-15.0209	-0.9163
EO	NEW	0.0000003195	0.40	-14.9565	-0.9163
BD	NEW	0.0000003254	13.80	-14.9382	2.6247
BD	NEW	0.0000003346	1.70	-14.9105	0.5306
BD	NEW	0.0000003430	1.35	-14.8856	0.3001
BD	NEW	0.0000003442	12.75	-14.8819	2.5455
BD	NEW	0.0000003939	4.00	-14.7473	1.3863
BD	NEW	0.0000003994	10.00	-14.7334	2.3026
EO	NEW	0.0000004007	0.80	-14.7300	-0.2231
BD	NEW	0.0000004288	4.00	-14.6623	1.3863
BD	NEW	0.0000004757	1.50	-14.5586	0.4055
EO	NEW	0.0000004798	999.00	-14.5499	6.9068
EO	NEW	0.0000005309	399.40	-14.4486	5.9900
EO	NEW	0.0000005812	2.75	-14.3582	1.0116
EO	NEW	0.0000005944	28.50	-14.3357	3.3499
EO	NEW	0.0000006075	128.00	-14.3140	4.8520
BD	NEW	0.0000006524	97.00	-14.2426	4.5747
EO	NEW	0.0000007355	3.50	-14.1227	1.2528
BD	NEW	0.0000007648	3.25	-14.0837	1.1787
BD	NEW	0.0000008560	8.50	-13.9710	2.1401
BD	NEW	0.0000008798	28.50	-13.9436	3.3499
BD	NEW	0.0000008869	2.00	-13.9356	0.6931
EO	NEW	0.0000008924	8.30	-13.9293	2.1163
EO	NEW	0.0000009888	4.25	-13.8267	1.4469
BD	NEW	0.0000010715	17.00	-13.7464	2.8332
EO	NEW	0.0000012661	1.00	-13.5795	0.0000
EO	NEW	0.0000016351	4.50	-13.3238	1.5041
BD	NEW	0.0000017995	4.00	-13.2280	1.3863
BD	NEW	0.0000018303	19.25	-13.2110	2.9575
BD	NEW	0.0000020777	3.50	-13.0842	1.2528
BD	NEW	0.0000022858	3.75	-12.9888	1.3218
EO	NEW	0.0000032725	3.00	-12.6300	1.0986

Table B-1-1. Bagging data used to develop the correlation equations

----- Equipment Type=CONNECTOR Service=ALL -----
 (continued)

Plant Type	Data Origin	Measured Emission Rate (kg/hr)	Screening Value (ppmv)	Natural Log of Emission Rate (kg/hr)	Natural Log of Screening Value (ppmv)
EO	NEW	0.0000036190	1.60	-12.5293	0.4700
BD	NEW	0.0000036396	0.80	-12.5236	-0.2231
BD	NEW	0.0000038387	8.50	-12.4704	2.1401
EO	NEW	0.0000041625	6.50	-12.3894	1.8718
EO	NEW	0.0000044784	48.00	-12.3162	3.8712
BD	NEW	0.0000046207	7.80	-12.2850	2.0541
BD	NEW	0.0000057784	41.50	-12.0614	3.7257
BD	NEW	0.0000080668	12.00	-11.7278	2.4849
BD	NEW	0.0000095125	100.00	-11.5629	4.6052
EO	NEW	0.0000100797	297.00	-11.5050	5.6937
BD	NEW	0.0000137255	19.75	-11.1963	2.9832
BD	NEW	0.0000140845	4.50	-11.1704	1.5041
BD	NEW	0.0000140911	14.00	-11.1700	2.6391
EO	NEW	0.0000142252	63.50	-11.1605	4.1510
BD	NEW	0.0000143958	195.50	-11.1486	5.2756
BD	NEW	0.0000151611	16.00	-11.0968	2.7726
BD	NEW	0.0000161064	13.50	-11.0363	2.6027
EO	NEW	0.0000166253	18.50	-11.0046	2.9178
BD	NEW	0.0000168916	195.00	-10.9887	5.2730
EO	NEW	0.0000178679	0.95	-10.9325	-0.0513
BD	NEW	0.0000183124	123.50	-10.9079	4.8162
BD	NEW	0.0000191290	4995.00	-10.8643	8.5162
BD	NEW	0.0000194650	16.50	-10.8469	2.8034
EO	NEW	0.0000197515	50.50	-10.8323	3.9220
BD	NEW	0.0000198244	23.00	-10.8286	3.1355
BD	NEW	0.0000227951	320.50	-10.6890	5.7699
BD	NEW	0.0000279813	67.00	-10.4840	4.2047
BD	NEW	0.0000348217	18.00	-10.2653	2.8904
BD	NEW	0.0000351763	195.50	-10.2551	5.2756
BD	NEW	0.0000359334	9.00	-10.2338	2.1972
BD	NEW	0.0000403480	198.00	-10.1180	5.2883
BD	NEW	0.0000423987	472.00	-10.0684	6.1570
BD	NEW	0.0000445724	13.00	-10.0184	2.5649
EO	NEW	0.0000509982	25.00	-9.8837	3.2189
EO	NEW	0.0000512445	323.00	-9.8789	5.7777
BD	NEW	0.0000595643	275.00	-9.7285	5.6168
BD	NEW	0.0000758688	35.00	-9.4865	3.5553
BD	NEW	0.0000860423	98.00	-9.3607	4.5850
BD	NEW	0.0000910990	1049.00	-9.3036	6.9556
BD	NEW	0.0000947099	94.40	-9.2647	4.5475
BD	NEW	0.0001007398	197.50	-9.2030	5.2857
BD	NEW	0.0001051050	38.80	-9.1606	3.6584
BD	NEW	0.0001178839	94.80	-9.0458	4.5518
BD	NEW	0.0001397861	371.00	-8.8754	5.9162

Table B-1-1. Bagging data used to develop the correlation equations

----- Equipment Type=CONNECTOR Service=ALL -----
 (continued)

Plant Type	Data Origin	Measured Emission Rate (kg/hr)	Screening Value (ppmv)	Natural Log of Emission Rate (kg/hr)	Natural Log of Screening Value (ppmv)
BD	NEW	0.0001721438	54.90	-8.6672	4.0055
BD	NEW	0.0001806903	4747.00	-8.6187	8.4653
BD	NEW	0.0002038979	895.00	-8.4979	6.7968
BD	NEW	0.0002463283	97.00	-8.3088	4.5747
BD	NEW	0.0002731277	549.00	-8.2056	6.3081
BD	NEW	0.0002853205	345.00	-8.1619	5.8435
BD	NEW	0.0003727741	198.50	-7.8945	5.2908
BD	NEW	0.0004184529	199.00	-7.7789	5.2933
BD	NEW	0.0005627360	195.00	-7.4827	5.2730
EO	NEW	0.0008093015	997.00	-7.1193	6.9048
BD	NEW	0.0008566981	99.00	-7.0624	4.5951
BD	NEW	0.0013381945	1049.00	-6.6164	6.9556
BD	NEW	0.0013408366	999.00	-6.6145	6.9068
BD	NEW	0.0017192076	471.50	-6.3659	6.1559
BD	NEW	0.0021650014	1997.00	-6.1353	7.5994
BD	NEW	0.0085056085	2999.00	-4.7670	8.0060
BD	NEW	0.0101785661	3996.00	-4.5875	8.2930
BD	NEW	0.0587476684	99998.80	-2.8345	11.5129

N = 107 (0 outliers)

Table B-1-1. Bagging data used to develop the correlation equations

----- Equipment Type=PUMP Service=LL -----

Plant Type	Data Origin	Measured Emission Rate (kg/hr)	Screening Value (ppmv)	Natural Log of Emission Rate (kg/hr)	Natural Log of Screening Value (ppmv)	Outlier Flag
BD	NEW	0.0000003333	3.00	-14.9141	1.0986	
BD	NEW	0.0000003346	64.40	-14.9104	4.1651	OUTLIER
BD	NEW	0.0000004908	1.30	-14.5272	0.2624	
EO	NEW	0.0000012091	4.00	-13.6256	1.3863	
BD	NEW	0.0000021532	9.50	-13.0486	2.2513	
EO	NEW	0.0000038359	768.00	-12.4711	6.6438	OUTLIER
EO	NEW	0.0000055733	49.00	-12.0975	3.8918	
EO	NEW	0.0000067016	8.40	-11.9132	2.1282	
RE	OLD	0.0000068315	42.53	-11.8940	3.7503	
EO	NEW	0.0000115240	3.00	-11.3711	1.0986	
EO	NEW	0.0000137032	1.00	-11.1979	0.0000	
BD	NEW	0.0000173708	15.00	-10.9607	2.7081	
RE	OLD	0.0000182707	83.26	-10.9102	4.4220	
BD	NEW	0.0000218470	21.00	-10.7314	3.0445	
BD	NEW	0.0000234610	8.00	-10.6602	2.0794	
BD	NEW	0.0000243023	10.00	-10.6249	2.3026	
BD	NEW	0.0000262744	95.00	-10.5469	4.5539	
RE	OLD	0.0000273344	647.80	-10.5074	6.4736	
BD	NEW	0.0000287475	7.80	-10.4570	2.0541	
RE	OLD	0.0000343297	719.36	-10.2795	6.5784	
EO	NEW	0.0000385230	13.90	-10.1643	2.6319	
BD	NEW	0.0000418537	394.00	-10.0813	5.9764	
BD	NEW	0.0000474696	4.00	-9.9554	1.3863	
EO	NEW	0.0000588925	2.75	-9.7398	1.0116	
BD	NEW	0.0000715064	33.00	-9.5457	3.4965	
EO	NEW	0.0000722114	180.00	-9.5359	5.1930	
BD	NEW	0.0000978468	1.00	-9.2321	0.0000	
BD	NEW	0.0001152858	2.75	-9.0681	1.0116	
EO	NEW	0.0001232483	74.00	-9.0013	4.3041	
EO	NEW	0.0001803724	44.00	-8.6205	3.7842	
RE	OLD	0.0001957145	47.12	-8.5389	3.8526	
RE	OLD	0.0001991513	49.68	-8.5214	3.9057	
RE	OLD	0.0002209241	744.91	-8.4177	6.6133	
BD	NEW	0.0002667811	892.50	-8.2291	6.7940	
RE	OLD	0.0002999432	2388.28	-8.1119	7.7783	
BD	NEW	0.0003013546	65.00	-8.1072	4.1744	
RE	OLD	0.0004782523	49.86	-7.6454	3.9091	
EO	NEW	0.0005168934	105.00	-7.5677	4.6540	
EO	NEW	0.0005477897	499.00	-7.5096	6.2126	
RE	OLD	0.0005646821	16033.45	-7.4792	9.6824	
EO	NEW	0.0005681949	595.00	-7.4730	6.3886	
EO	NEW	0.0005857415	349.00	-7.4426	5.8551	
RE	OLD	0.0006402389	3102.49	-7.3537	8.0400	
EO	NEW	0.0006886734	199.00	-7.2807	5.2933	
BD	NEW	0.0007364641	598.00	-7.2137	6.3936	

Table B-1-1. Bagging data used to develop the correlation equations

----- Equipment Type=PUMP Service=LL -----
 (continued)

Plant Type	Data Origin	Measured Emission Rate (kg/hr)	Screening Value (ppmv)	Natural Log of Emission Rate (kg/hr)	Natural Log of Screening Value (ppmv)	Outlier Flag
RE	OLD	0.0007563452	1378.39	-7.1870	7.2287	
RE	OLD	0.0007987816	8095.43	-7.1324	8.9991	
RE	OLD	0.0009912542	289.26	-6.9165	5.6673	
BD	NEW	0.0010889569	471.00	-6.8225	6.1549	
RE	OLD	0.0011480956	521.79	-6.7697	6.2573	
BD	NEW	0.0012930833	348.00	-6.6507	5.8522	
RE	OLD	0.0013248663	2221.10	-6.6264	7.7058	
BD	NEW	0.0014886548	3197.00	-6.5099	8.0700	
EO	NEW	0.0016401471	101.20	-6.4130	4.6171	
RE	OLD	0.0017660014	24145.32	-6.3390	10.0918	
BD	NEW	0.0018539657	299.00	-6.2904	5.7004	
BD	NEW	0.0021087390	997.00	-6.1617	6.9048	
EO	NEW	0.0022296212	2000.00	-6.1059	7.6009	
BD	NEW	0.0023007567	5499.25	-6.0745	8.6124	
BD	NEW	0.0025947420	1993.80	-5.9543	7.5978	
RE	OLD	0.0027435637	2125.99	-5.8985	7.6620	
RE	OLD	0.0029144932	5870.47	-5.8381	8.6777	
BD	NEW	0.0029456140	5.75	-5.8274	1.7492	
BD	NEW	0.0033415187	125.00	-5.7013	4.8283	
BD	NEW	0.0036014533	1899.00	-5.6264	7.5491	
BD	NEW	0.0036569429	1393.90	-5.6111	7.2399	
EO	NEW	0.0037009240	3197.50	-5.5992	8.0701	
BD	NEW	0.0037297151	599.00	-5.5914	6.3953	
BD	NEW	0.0039913442	700.00	-5.5236	6.5511	
RE	OLD	0.0041248489	2775.53	-5.4907	7.9286	
RE	OLD	0.0046220969	16654.09	-5.3769	9.7204	
RE	OLD	0.0046281246	6538.83	-5.3756	8.7855	
BD	NEW	0.0050222262	1099.00	-5.2939	7.0022	
RE	OLD	0.0054013839	9501.80	-5.2211	9.1592	
BD	NEW	0.0055450728	2998.00	-5.1948	8.0057	
RE	OLD	0.0070361493	1381.77	-4.9567	7.2311	
BD	NEW	0.0071307927	27.60	-4.9433	3.3178	
BD	NEW	0.0081605157	6498.00	-4.8084	8.7792	
EO	NEW	0.0090139120	7696.90	-4.7090	8.9486	
BD	NEW	0.0098565101	2548.00	-4.6196	7.8431	
BD	NEW	0.0101206645	2997.00	-4.5932	8.0054	
RE	OLD	0.0108936908	12820.53	-4.5196	9.4588	
RE	OLD	0.0110475772	14254.89	-4.5055	9.5649	
BD	NEW	0.0115165376	3194.50	-4.4640	8.0692	
RE	OLD	0.0120415404	20840.78	-4.4194	9.9447	
RE	OLD	0.0120492786	19187.09	-4.4188	9.8620	
BD	NEW	0.0126046858	5248.25	-4.3737	8.5656	
RE	OLD	0.0135546418	15011.05	-4.3010	9.6165	
RE	OLD	0.0138366847	10491.80	-4.2804	9.2583	

Table B-1-1. Bagging data used to develop the correlation equations

----- Equipment Type=PUMP Service=LL -----
 (continued)

Plant Type	Data Origin	Measured Emission Rate (kg/hr)	Screening Value (ppmv)	Natural Log of Emission Rate (kg/hr)	Natural Log of Screening Value (ppmv)	Outlier Flag
BD	NEW	0.0154757686	3998.50	-4.1685	8.2937	
BD	NEW	0.0155724932	3998.00	-4.1622	8.2935	
RE	OLD	0.0156873305	300.60	-4.1549	5.7058	
RE	OLD	0.0159032925	51041.21	-4.1412	10.8404	
RE	OLD	0.0196113751	88270.79	-3.9316	11.3882	
BD	NEW	0.0198424922	2748.50	-3.9199	7.9188	
BD	NEW	0.0219422932	797.00	-3.8193	6.6809	
RE	OLD	0.0220953073	38632.61	-3.8124	10.5619	
BD	NEW	0.0221617288	6996.50	-3.8094	8.8532	
RE	OLD	0.0226278893	12142.30	-3.7886	9.4045	
RE	OLD	0.0232021936	22078.88	-3.7635	10.0024	
RE	OLD	0.0258831450	10996.59	-3.6542	9.3053	
RE	OLD	0.0263221310	8527.17	-3.6373	9.0510	
RE	OLD	0.0274280572	193253.34	-3.5962	12.1718	
RE	OLD	0.0300037851	12130.06	-3.5064	9.4034	
RE	OLD	0.0305561087	16850.04	-3.4882	9.7321	
RE	OLD	0.0361388265	9472.44	-3.3204	9.1561	
RE	OLD	0.0371630240	37500.32	-3.2924	10.5321	
RE	OLD	0.0409811410	12196.61	-3.1946	9.4089	
RE	OLD	0.0476567087	130564.77	-3.0437	11.7796	
RE	OLD	0.0480145702	23101.38	-3.0363	10.0476	
BD	NEW	0.0492542578	5998.00	-3.0108	8.6992	
RE	OLD	0.0556463965	38446.34	-2.8887	10.5570	
RE	OLD	0.0572488867	3111.50	-2.8603	8.0429	
RE	OLD	0.0586671574	41504.10	-2.8359	10.6335	
BD	NEW	0.0863688407	99996.00	-2.4491	11.5129	
RE	OLD	0.0977863072	88269.36	-2.3250	11.3881	
BD	NEW	0.1039387219	5997.00	-2.2640	8.6990	
RE	OLD	0.1074526291	45285.17	-2.2307	10.7207	
BD	NEW	0.2535689673	99994.00	-1.3721	11.5129	

N = 119 (2 outliers)

Table B-1-1. Bagging data used to develop the correlation equations

----- Equipment Type=VALVE Service=G -----

Plant Type	Data Origin	Measured Emission Rate (kg/hr)	Screening Value (ppmv)	Natural Log of Emission Rate (kg/hr)	Natural Log of Screening Value (ppmv)	Outlier Flag
EO	NEW	0.0000000717	37.50	-16.4508	3.6243	
EO	NEW	0.0000000720	35.00	-16.4468	3.5553	
EO	NEW	0.0000000737	2.00	-16.4235	0.6931	
BD	NEW	0.0000001062	1.00	-16.0577	0.0000	
EO	NEW	0.0000001082	4.00	-16.0396	1.3863	
EO	NEW	0.0000001147	4.00	-15.9811	1.3863	
EO	NEW	0.0000001167	0.10	-15.9641	-2.3026	
EO	NEW	0.0000001170	9.00	-15.9608	2.1972	
EO	NEW	0.0000001172	5.00	-15.9591	1.6094	
EO	NEW	0.0000001198	4.00	-15.9374	1.3863	
EO	NEW	0.0000001251	21.50	-15.8945	3.0681	
EO	NEW	0.0000001525	1.20	-15.6963	0.1823	
EO	NEW	0.0000001579	1.00	-15.6615	0.0000	
EO	NEW	0.0000001705	2.00	-15.5848	0.6931	
EO	NEW	0.0000001964	98.25	-15.4430	4.5875	
EO	NEW	0.0000002292	3.00	-15.2887	1.0986	
EO	NEW	0.0000002537	224.30	-15.1869	5.4130	
EO	NEW	0.0000002824	9.00	-15.0800	2.1972	
BD	NEW	0.0000003468	6.20	-14.8747	1.8245	
BD	NEW	0.0000003511	1.75	-14.8622	0.5596	
EO	NEW	0.0000003724	0.40	-14.8032	-0.9163	
BD	NEW	0.0000004915	1.00	-14.5259	0.0000	
BD	NEW	0.0000005202	1.50	-14.4690	0.4055	
EO	NEW	0.0000005222	108.00	-14.4652	4.6821	
EO	NEW	0.0000005551	4.00	-14.4041	1.3863	
BD	NEW	0.0000006288	1.25	-14.2795	0.2231	
EO	NEW	0.0000007041	0.20	-14.1663	-1.6094	
EO	NEW	0.0000007204	1497.50	-14.1434	7.3116	
BD	NEW	0.0000007597	2.50	-14.0903	0.9163	
EO	NEW	0.0000008744	68.90	-13.9497	4.2327	
EO	NEW	0.0000010541	198.00	-13.7628	5.2883	
BD	NEW	0.0000013384	51.50	-13.5241	3.9416	
BD	NEW	0.0000013799	3499.30	-13.4935	8.1603	
BD	NEW	0.0000013870	15.70	-13.4884	2.7537	
BD	NEW	0.0000018645	6.00	-13.1925	1.7918	
BD	NEW	0.0000018779	1.50	-13.1854	0.4055	
EO	NEW	0.0000021100	99.00	-13.0688	4.5951	
EO	NEW	0.0000022366	0.20	-13.0105	-1.6094	
EO	NEW	0.0000024148	598.00	-12.9339	6.3936	
BD	NEW	0.0000025627	28.00	-12.8744	3.3322	
EO	NEW	0.0000034003	678.00	-12.5916	6.5191	
BD	NEW	0.0000036200	6.00	-12.5290	1.7918	
EO	NEW	0.0000036375	19.00	-12.5242	2.9444	
EO	NEW	0.0000038715	118.25	-12.4619	4.7728	
EO	NEW	0.0000042396	38.40	-12.3710	3.6481	

Table B-1-1. Bagging data used to develop the correlation equations

----- Equipment Type=VALVE Service=G -----
 (continued)

Plant Type	Data Origin	Measured Emission Rate (kg/hr)	Screening Value (ppmv)	Natural Log of Emission Rate (kg/hr)	Natural Log of Screening Value (ppmv)	Outlier Flag
BD	NEW	0.0000045549	5.40	-12.2993	1.6864	
EO	NEW	0.0000056834	9.50	-12.0780	2.2513	
BD	NEW	0.0000061124	4.00	-12.0052	1.3863	
EO	NEW	0.0000070548	2.10	-11.8618	0.7419	
BD	NEW	0.0000074252	17.50	-11.8106	2.8622	
BD	NEW	0.0000080241	3.40	-11.7331	1.2238	
EO	NEW	0.0000083624	40.15	-11.6918	3.6926	
RE	OLD	0.0000118648	20.46	-11.3419	3.0184	
BD	NEW	0.0000128110	8.50	-11.2652	2.1401	
BD	NEW	0.0000137662	83.90	-11.1933	4.4296	
RE	OLD	0.0000149663	4952.69	-11.1097	8.5077	
RE	OLD	0.0000166075	4954.50	-11.0057	8.5081	
RE	OLD	0.0000175591	1007.37	-10.9499	6.9151	
EO	NEW	0.0000214657	698.50	-10.7491	6.5489	
BD	NEW	0.0000220929	20.50	-10.7203	3.0204	
EO	NEW	0.0000243523	850.00	-10.6229	6.7452	
BD	NEW	0.0000246644	144.50	-10.6101	4.9733	
BD	NEW	0.0000263657	139.25	-10.5434	4.9363	
BD	NEW	0.0000285391	15.50	-10.4642	2.7408	
BD	NEW	0.0000298709	109.00	-10.4186	4.6913	
RE	OLD	0.0000357822	2987.55	-10.2381	8.0022	
RE	OLD	0.0000359337	2497.04	-10.2338	7.8229	
BD	NEW	0.0000365393	598.00	-10.2171	6.3936	
BD	NEW	0.0000395358	3.50	-10.1383	1.2528	
BD	NEW	0.0000421641	98.50	-10.0739	4.5901	
RE	OLD	0.0000440123	2282.07	-10.0310	7.7328	
EO	NEW	0.0000445925	17.50	-10.0179	2.8622	
BD	NEW	0.0000523996	78.00	-9.8566	4.3567	
BD	NEW	0.0000557747	119.00	-9.7942	4.7791	
RE	OLD	0.0000617007	2670.91	-9.6932	7.8902	
RE	OLD	0.0000647076	1740.60	-9.6456	7.4620	
RE	OLD	0.0000724907	680.87	-9.5321	6.5234	
RE	OLD	0.0000779572	1315.53	-9.4594	7.1820	
RE	OLD	0.0000833618	290.43	-9.3923	5.6714	
RE	OLD	0.0000996210	700.59	-9.2141	6.5519	
RE	OLD	0.0001071514	4740.81	-9.1413	8.4640	
RE	OLD	0.0001137777	4385.68	-9.0813	8.3861	
BD	NEW	0.0001197735	474.40	-9.0299	6.1621	
RE	OLD	0.0001341897	987.15	-8.9163	6.8948	
RE	OLD	0.0001376705	496.21	-8.8906	6.2070	
RE	OLD	0.0001518078	1224.74	-8.7929	7.1105	
RE	OLD	0.0001625511	24157.28	-8.7245	10.0923	
EO	NEW	0.0001720041	498.75	-8.6680	6.2121	
RE	OLD	0.0001766026	7061.58	-8.6416	8.8624	

Table B-1-1. Bagging data used to develop the correlation equations

----- Equipment Type=VALVE Service=G -----
 (continued)

Plant Type	Data Origin	Measured Emission Rate (kg/hr)	Screening Value (ppmv)	Natural Log of Emission Rate (kg/hr)	Natural Log of Screening Value (ppmv)	Outlier Flag
BD	NEW	0.0001866845	824.40	-8.5861	6.7147	
RE	OLD	0.0001904680	1643.51	-8.5660	7.4046	
RE	OLD	0.0001964120	1423.98	-8.5353	7.2612	
RE	OLD	0.0001977607	24689.43	-8.5285	10.1141	
RE	OLD	0.0002152405	1556.44	-8.4438	7.3502	
RE	OLD	0.0002180108	2095.88	-8.4310	7.6477	
RE	OLD	0.0002232184	3292.43	-8.4074	8.0994	
RE	OLD	0.0002275124	6482.10	-8.3883	8.7768	
RE	OLD	0.0002307162	4804.03	-8.3743	8.4772	
RE	OLD	0.0002322459	4368.95	-8.3677	8.3823	
BD	NEW	0.0002437423	499.40	-8.3194	6.2134	
RE	OLD	0.0002528838	928.66	-8.2826	6.8337	
RE	OLD	0.0002757637	877.50	-8.1960	6.7771	
BD	NEW	0.0002760188	6695.10	-8.1950	8.8091	
EO	NEW	0.0002904846	8998.00	-8.1440	9.1048	
RE	OLD	0.0003425098	2139.46	-7.9792	7.6683	
EO	NEW	0.0003724437	9998.00	-7.8954	9.2101	
BD	NEW	0.0003991030	394.00	-7.8263	5.9764	
RE	OLD	0.0004050504	9863.86	-7.8115	9.1966	
BD	NEW	0.0004404057	1999.00	-7.7278	7.6004	
RE	OLD	0.0004427801	4287.44	-7.7224	8.3634	
RE	OLD	0.0004461460	18661.82	-7.7149	9.8342	
BD	NEW	0.0004471948	799.00	-7.7125	6.6834	
RE	OLD	0.0004520589	55794.96	-7.7017	10.9294	
RE	OLD	0.0004529831	4949.37	-7.6997	8.5070	
RE	OLD	0.0004536846	3965.77	-7.6981	8.2855	
RE	OLD	0.0004640417	560.84	-7.6755	6.3294	
RE	OLD	0.0004685177	4279.25	-7.6659	8.3615	
RE	OLD	0.0004728028	14956.09	-7.6568	9.6129	
RE	OLD	0.0005228957	4399.96	-7.5561	8.3894	
RE	OLD	0.0005323154	2867.11	-7.5383	7.9611	
RE	OLD	0.0005465275	16699.10	-7.5119	9.7231	
BD	NEW	0.0005634682	2999.70	-7.4814	8.0063	
BD	NEW	0.0005651718	247.00	-7.4784	5.5094	
RE	OLD	0.0005730494	2037.49	-7.4645	7.6195	
RE	OLD	0.0005839129	35105.41	-7.4458	10.4661	
RE	OLD	0.0005991093	246.51	-7.4201	5.5074	
RE	OLD	0.0006007199	27836.27	-7.4174	10.2341	
RE	OLD	0.0006146615	1592.14	-7.3944	7.3728	
BD	NEW	0.0006404920	2743.50	-7.3533	7.9170	
RE	OLD	0.0006448431	2313.46	-7.3465	7.7465	
BD	NEW	0.0007363507	1247.00	-7.2138	7.1285	
EO	NEW	0.0009188385	3448.00	-6.9924	8.1455	
RE	OLD	0.0009212745	2316.36	-6.9898	7.7478	

Table B-1-1. Bagging data used to develop the correlation equations

----- Equipment Type=VALVE Service=G -----
 (continued)

Plant Type	Data Origin	Measured Emission Rate (kg/hr)	Screening Value (ppmv)	Natural Log of Emission Rate (kg/hr)	Natural Log of Screening Value (ppmv)	Outlier Flag
RE	OLD	0.0009386789	7331.62	-6.9710	8.9000	
RE	OLD	0.0009859662	32119.44	-6.9219	10.3772	
RE	OLD	0.0011533445	2785.34	-6.7651	7.9321	
RE	OLD	0.0011636438	2797.20	-6.7562	7.9364	
RE	OLD	0.0011668930	203224.00	-6.7534	12.2221	
RE	OLD	0.0011712242	21751.69	-6.7497	9.9874	
RE	OLD	0.0017829290	67504.85	-6.3295	11.1200	
RE	OLD	0.0019401846	56199.96	-6.2450	10.9367	
RE	OLD	0.0020010182	8684.64	-6.2141	9.0693	
RE	OLD	0.0022581253	4284.86	-6.0932	8.3628	
RE	OLD	0.0022870889	3791.44	-6.0805	8.2405	
RE	OLD	0.0025260448	3163.33	-5.9811	8.0594	
RE	OLD	0.0025348896	534.08	-5.9776	6.2805	
RE	OLD	0.0026295658	50201.19	-5.9409	10.8238	
RE	OLD	0.0027833322	20393.42	-5.8841	9.9230	
RE	OLD	0.0029409798	4530.72	-5.8290	8.4186	
RE	OLD	0.0031312882	1860.09	-5.7663	7.5284	
BD	NEW	0.0031778789	4297.80	-5.7515	8.3659	
RE	OLD	0.0033409352	219611.97	-5.7015	12.2996	
RE	OLD	0.0033838729	23015.69	-5.6887	10.0439	
RE	OLD	0.0036846059	17536.22	-5.6036	9.7720	
RE	OLD	0.0036971583	16495.48	-5.6002	9.7108	
RE	OLD	0.0039426484	12647.22	-5.5359	9.4452	
RE	OLD	0.0039504089	34241.04	-5.5339	10.4412	
RE	OLD	0.0040050325	1333.88	-5.5202	7.1958	
RE	OLD	0.0041065399	4005.05	-5.4952	8.2953	
RE	OLD	0.0041660267	2803.86	-5.4808	7.9388	
RE	OLD	0.0046273787	20516.30	-5.3758	9.9290	
RE	OLD	0.0051511364	3629.80	-5.2685	8.1969	
RE	OLD	0.0060064387	760.42	-5.1149	6.6339	
RE	OLD	0.0064640997	61150.08	-5.0415	11.0211	
RE	OLD	0.0067947745	102781.04	-4.9916	11.5404	
RE	OLD	0.0086599432	287461.04	-4.7490	12.5688	
BD	NEW	0.0102338821	12994.00	-4.5821	9.4722	
RE	OLD	0.0112479155	9730.32	-4.4876	9.1830	
RE	OLD	0.0150883255	749143.47	-4.1938	13.5267	
RE	OLD	0.0192079955	191834.63	-3.9524	12.1644	
RE	OLD	0.0212769340	29340.67	-3.8501	10.2867	
RE	OLD	0.0262475666	189629.11	-3.6402	12.1528	
RE	OLD	0.0265051976	2373.75	-3.6304	7.7722	
RE	OLD	0.0277367164	820321.32	-3.5850	13.6175	
RE	OLD	0.0342721260	90882.86	-3.3734	11.4173	
RE	OLD	0.0449106195	17031.74	-3.1031	9.7428	
RE	OLD	0.0645502674	16874.50	-2.7403	9.7336	

Table B-1-1. Bagging data used to develop the correlation equations

----- Equipment Type=VALVE Service=G -----
 (continued)

Plant Type	Data Origin	Measured Emission Rate (kg/hr)	Screening Value (ppmv)	Natural Log of Emission Rate (kg/hr)	Natural Log of Screening Value (ppmv)	Outlier Flag
RE	OLD	0.1109042134	326432.21	-2.1991	12.6960	
RE	OLD	0.1140677949	20836.56	-2.1710	9.9445	

N = 179 (0 outliers)

Table B-1-1. Bagging data used to develop the correlation equations

----- Equipment Type=VALVE Service=LL -----

Plant Type	Data Origin	Measured Emission Rate (kg/hr)	Screening Value (ppmv)	Natural Log of Emission Rate (kg/hr)	Natural Log of Screening Value (ppmv)	Outlier Flag
EO	NEW	0.0000001148	2.00	-15.9798	0.6931	
EO	NEW	0.0000001182	0.40	-15.9509	-0.9163	
EO	NEW	0.0000001490	0.70	-15.7195	-0.3567	
EO	NEW	0.0000001545	7.00	-15.6828	1.9459	
BD	NEW	0.0000001546	2.00	-15.6825	0.6931	
BD	NEW	0.0000001705	2.25	-15.5843	0.8109	
EO	NEW	0.0000001748	13.50	-15.5593	2.6027	
BD	NEW	0.0000001777	1.50	-15.5431	0.4055	
EO	NEW	0.0000002092	0.90	-15.3801	-0.1054	
EO	NEW	0.0000002655	24.25	-15.1418	3.1884	
EO	NEW	0.0000002662	34.00	-15.1392	3.5264	
EO	NEW	0.0000002674	119.00	-15.1344	4.7791	
EO	NEW	0.0000002973	1.00	-15.0285	0.0000	
BD	NEW	0.0000003209	0.25	-14.9523	-1.3863	
BD	NEW	0.0000003246	14.00	-14.9406	2.6391	
BD	NEW	0.0000003272	145.00	-14.9326	4.9767	
BD	NEW	0.0000003761	1.00	-14.7934	0.0000	
EO	NEW	0.0000004160	1.10	-14.6925	0.0953	
BD	NEW	0.0000004269	2.50	-14.6668	0.9163	
EO	NEW	0.0000005550	0.60	-14.4043	-0.5108	
EO	NEW	0.0000006711	2.00	-14.2144	0.6931	
EO	NEW	0.0000006800	1547.50	-14.2011	7.3444	
EO	NEW	0.0000007182	2.80	-14.1465	1.0296	
BD	NEW	0.0000007281	1.30	-14.1328	0.2624	
EO	NEW	0.0000007741	1.85	-14.0715	0.6152	
EO	NEW	0.0000007760	0.45	-14.0691	-0.7985	
BD	NEW	0.0000009403	2.25	-13.8770	0.8109	
BD	NEW	0.0000009766	3.25	-13.8391	1.1787	
BD	NEW	0.0000010750	3.50	-13.7432	1.2528	
BD	NEW	0.0000013768	6.45	-13.4957	1.8641	
EO	NEW	0.0000014189	398.00	-13.4656	5.9865	
BD	NEW	0.0000017270	4.00	-13.2691	1.3863	

Table B-1-1. Bagging data used to develop the correlation equations

----- Equipment Type=VALVE Service=LL -----
 (continued)

Plant Type	Data Origin	Measured Emission Rate (kg/hr)	Screening Value (ppmv)	Natural Log of Emission Rate (kg/hr)	Natural Log of Screening Value (ppmv)	Outlier Flag
BD	NEW	0.0000021600	209.00	-13.0454	5.3423	
EO	NEW	0.0000026370	6.70	-12.8459	1.9021	
BD	NEW	0.0000026381	18.50	-12.8455	2.9178	
EO	NEW	0.0000028522	51.20	-12.7674	3.9357	
EO	NEW	0.0000031653	21.80	-12.6633	3.0819	
RE	OLD	0.0000032615	2740.82	-12.6333	7.9160	
BD	NEW	0.0000034734	13.50	-12.5704	2.6027	
BD	NEW	0.0000034854	486.75	-12.5669	6.1878	
BD	NEW	0.0000036357	1.40	-12.5247	0.3365	
BD	NEW	0.0000036487	3.05	-12.5211	1.1151	
BD	NEW	0.0000038172	0.20	-12.4760	-1.6094	
EO	NEW	0.0000038185	45.00	-12.4756	3.8067	
EO	NEW	0.0000045401	21.50	-12.3026	3.0681	
BD	NEW	0.0000048429	21.50	-12.2380	3.0681	
EO	NEW	0.0000053288	11.40	-12.1424	2.4336	
EO	NEW	0.0000054257	1.00	-12.1244	0.0000	
BD	NEW	0.0000054590	44.90	-12.1182	3.8044	
RE	OLD	0.0000061236	5194.17	-12.0034	8.5553	
EO	NEW	0.0000063620	4.80	-11.9652	1.5686	
EO	NEW	0.0000076923	30.00	-11.7753	3.4012	
BD	NEW	0.0000079625	195.50	-11.7408	5.2756	
BD	NEW	0.0000080291	20.85	-11.7324	3.0374	
BD	NEW	0.0000081895	17.75	-11.7127	2.8764	
BD	NEW	0.0000087183	0.25	-11.6501	-1.3863	
BD	NEW	0.0000090393	7.00	-11.6139	1.9459	
EO	NEW	0.0000096017	0.90	-11.5536	-0.1054	
EO	NEW	0.0000106063	29.00	-11.4541	3.3673	
BD	NEW	0.0000114056	2.40	-11.3814	0.8755	
EO	NEW	0.0000116662	90.00	-11.3588	4.4998	
RE	OLD	0.0000118300	97.72	-11.3449	4.5821	
BD	NEW	0.0000123249	21.90	-11.3039	3.0865	
BD	NEW	0.0000130315	20.00	-11.2481	2.9957	
BD	NEW	0.0000136318	49.80	-11.2031	3.9080	
EO	NEW	0.0000138914	39.40	-11.1842	3.6738	
RE	OLD	0.0000150006	500.63	-11.1074	6.2159	
EO	NEW	0.0000150217	108.00	-11.1060	4.6821	
BD	NEW	0.0000150810	32.50	-11.1021	3.4812	
BD	NEW	0.0000155478	54.50	-11.0716	3.9982	
RE	OLD	0.0000185551	78.10	-10.8948	4.3580	
RE	OLD	0.0000191256	191501.42	-10.8645	12.1627	OUTLIER
RE	OLD	0.0000196624	4878.72	-10.8368	8.4926	
BD	NEW	0.0000200735	250.00	-10.8161	5.5215	
BD	NEW	0.0000212478	67.00	-10.7593	4.2047	
EO	NEW	0.0000226439	44.10	-10.6956	3.7865	

Table B-1-1. Bagging data used to develop the correlation equations

----- Equipment Type=VALVE Service=LL -----
 (continued)

Plant Type	Data Origin	Measured Emission Rate (kg/hr)	Screening Value (ppmv)	Natural Log of Emission Rate (kg/hr)	Natural Log of Screening Value (ppmv)	Outlier Flag
EO	NEW	0.0000228716	74.80	-10.6856	4.3148	
EO	NEW	0.0000242425	2.40	-10.6274	0.8755	
BD	NEW	0.0000244394	35.50	-10.6193	3.5695	
RE	OLD	0.0000269514	5443.31	-10.5215	8.6021	
BD	NEW	0.0000298536	298.90	-10.4192	5.7001	
EO	NEW	0.0000301615	148.00	-10.4089	4.9972	
EO	NEW	0.0000330901	59.25	-10.3163	4.0818	
BD	NEW	0.0000336994	92.50	-10.2980	4.5272	
BD	NEW	0.0000354699	28.50	-10.2468	3.3499	
RE	OLD	0.0000378083	604.46	-10.1830	6.4043	
EO	NEW	0.0000382742	657.80	-10.1707	6.4889	
EO	NEW	0.0000383797	243.60	-10.1680	5.4955	
RE	OLD	0.0000387557	242.12	-10.1582	5.4894	
EO	NEW	0.0000387574	48.90	-10.1582	3.8898	
BD	NEW	0.0000407202	29.00	-10.1088	3.3673	
BD	NEW	0.0000415953	1349.80	-10.0875	7.2077	
RE	OLD	0.0000417925	42609.46	-10.0828	10.6598	
BD	NEW	0.0000429883	248.00	-10.0546	5.5134	
BD	NEW	0.0000443510	99.00	-10.0234	4.5951	
BD	NEW	0.0000462778	1.75	-9.9808	0.5596	
RE	OLD	0.0000470621	906.10	-9.9640	6.8091	
RE	OLD	0.0000482670	10833.21	-9.9388	9.2904	
EO	NEW	0.0000508340	79.00	-9.8869	4.3694	
RE	OLD	0.0000529921	890.55	-9.8454	6.7918	
RE	OLD	0.0000546755	1193.53	-9.8141	7.0847	
EO	NEW	0.0000561055	348.00	-9.7883	5.8522	
EO	NEW	0.0000569507	60.00	-9.7733	4.0943	
EO	NEW	0.0000626293	163.70	-9.6783	5.0980	
RE	OLD	0.0000626636	1985.67	-9.6777	7.5937	
RE	OLD	0.0000654535	318.60	-9.6342	5.7639	
RE	OLD	0.0000660567	5226.31	-9.6250	8.5615	
RE	OLD	0.00006664281	4914.24	-9.6194	8.4999	
EO	NEW	0.0000713497	343.00	-9.5479	5.8377	
RE	OLD	0.0000749810	1458.90	-9.4983	7.2854	
EO	NEW	0.0000778658	148.50	-9.4605	5.0006	
BD	NEW	0.0000893438	350.00	-9.3230	5.8579	
BD	NEW	0.0000936958	199.75	-9.2755	5.2971	
BD	NEW	0.0001029548	872.75	-9.1812	6.7716	
EO	NEW	0.0001063538	148.75	-9.1487	5.0023	
BD	NEW	0.0001147397	499.50	-9.0728	6.2136	
RE	OLD	0.0001266782	1183.21	-8.9739	7.0760	
BD	NEW	0.0001377292	73.00	-8.8902	4.2905	
BD	NEW	0.0001972580	174.75	-8.5310	5.1634	
RE	OLD	0.0002313295	50044.57	-8.3717	10.8207	

Table B-1-1. Bagging data used to develop the correlation equations

----- Equipment Type=VALVE Service=LL -----
 (continued)

Plant Type	Data Origin	Measured Emission Rate (kg/hr)	Screening Value (ppmv)	Natural Log of Emission Rate (kg/hr)	Natural Log of Screening Value (ppmv)	Outlier Flag
BD	NEW	0.0002317965	180.00	-8.3697	5.1930	
RE	OLD	0.0002524777	12405.49	-8.2842	9.4259	
RE	OLD	0.0002580228	44328.29	-8.2625	10.6994	
RE	OLD	0.0002594664	510.60	-8.2569	6.2356	
RE	OLD	0.0002714139	185.88	-8.2119	5.2251	
RE	OLD	0.0002825941	6976.92	-8.1715	8.8504	
RE	OLD	0.0002947841	1516.43	-8.1293	7.3241	
RE	OLD	0.0003011106	44592.42	-8.1080	10.7053	
RE	OLD	0.0003056054	181.92	-8.0932	5.2036	
RE	OLD	0.0003367527	88.38	-7.9962	4.4816	
RE	OLD	0.0003494725	1041.01	-7.9591	6.9479	
RE	OLD	0.0003655199	17367.57	-7.9142	9.7624	
RE	OLD	0.0003726697	856.19	-7.8948	6.7525	
RE	OLD	0.0003738730	8088.28	-7.8916	8.9982	
RE	OLD	0.0003743390	1959.19	-7.8903	7.5803	
RE	OLD	0.0003964414	4048.28	-7.8330	8.3060	
RE	OLD	0.0004653107	35414.65	-7.6728	10.4749	
BD	NEW	0.0004698821	1543.75	-7.6630	7.3420	
RE	OLD	0.0004809845	4284.78	-7.6397	8.3628	
RE	OLD	0.0004922594	104088.32	-7.6165	11.5530	
BD	NEW	0.0005246367	2645.50	-7.5528	7.8806	
RE	OLD	0.0005251847	1151.37	-7.5518	7.0487	
RE	OLD	0.0005308943	14765.02	-7.5409	9.6000	
RE	OLD	0.0005614771	97.30	-7.4849	4.5778	
BD	NEW	0.0005705547	358.30	-7.4689	5.8814	
RE	OLD	0.0006267770	1565.55	-7.3749	7.3560	
RE	OLD	0.0006426108	5861.53	-7.3500	8.6762	
RE	OLD	0.0006597100	1793.09	-7.3237	7.4917	
BD	NEW	0.0006830173	94.75	-7.2890	4.5512	
RE	OLD	0.0007019466	8827.10	-7.2617	9.0856	
RE	OLD	0.0007129023	9940.79	-7.2462	9.2044	
RE	OLD	0.0007649183	25559.24	-7.1757	10.1488	
RE	OLD	0.0007702967	14.18	-7.1687	2.6518	
RE	OLD	0.0008350761	1281.36	-7.0880	7.1557	
BD	NEW	0.0008369235	6097.00	-7.0858	8.7156	
RE	OLD	0.0008536995	2810.09	-7.0659	7.9410	
RE	OLD	0.0008577230	6709.07	-7.0612	8.8112	
RE	OLD	0.0009616788	46673.57	-6.9468	10.7509	
RE	OLD	0.0010351161	71798.27	-6.8732	11.1816	
RE	OLD	0.0010736310	3136.03	-6.8367	8.0507	
RE	OLD	0.0012337497	8519.07	-6.6977	9.0501	
RE	OLD	0.0012793343	16658.85	-6.6614	9.7207	
RE	OLD	0.0013448227	962.89	-6.6115	6.8699	
RE	OLD	0.0013933013	1602.40	-6.5761	7.3793	

Table B-1-1. Bagging data used to develop the correlation equations

----- Equipment Type=VALVE Service=LL -----
 (continued)

Plant Type	Data Origin	Measured Emission Rate (kg/hr)	Screening Value (ppmv)	Natural Log of Emission Rate (kg/hr)	Natural Log of Screening Value (ppmv)	Outlier Flag
RE	OLD	0.0014732045	22177.98	-6.5203	10.0069	
RE	OLD	0.0016009142	22172.87	-6.4372	10.0066	
RE	OLD	0.0018373887	1769.15	-6.2994	7.4783	
RE	OLD	0.0018697565	25877.90	-6.2819	10.1611	
RE	OLD	0.0021076721	93629.13	-6.1622	11.4471	
RE	OLD	0.0022196068	4376.80	-6.1104	8.3841	
BD	NEW	0.0023716142	1495.00	-6.0442	7.3099	
RE	OLD	0.0026041383	1313.08	-5.9507	7.1801	
RE	OLD	0.0026564280	52084.68	-5.9308	10.8606	
RE	OLD	0.0030068935	45068.90	-5.8068	10.7159	
RE	OLD	0.0030297587	6771.42	-5.7993	8.8205	
RE	OLD	0.0032025436	9836.80	-5.7438	9.1939	
RE	OLD	0.0032489277	140865.29	-5.7294	11.8556	
RE	OLD	0.0032868739	134149.17	-5.7178	11.8067	
RE	OLD	0.0034814651	284948.25	-5.6603	12.5601	
RE	OLD	0.0034830527	59618.63	-5.6598	10.9957	
RE	OLD	0.0035502018	4839.96	-5.6408	8.4847	
RE	OLD	0.0036059944	5555.74	-5.6252	8.6226	
RE	OLD	0.0037109239	72002.57	-5.5965	11.1845	
RE	OLD	0.0037115648	24755.46	-5.5963	10.1168	
RE	OLD	0.0038957946	9810.65	-5.5479	9.1912	
BD	NEW	0.0038969686	1544.40	-5.5476	7.3424	
RE	OLD	0.0039248950	7476.44	-5.5404	8.9195	
RE	OLD	0.0040089261	13953.59	-5.5192	9.5435	
RE	OLD	0.0042596218	30597.64	-5.4586	10.3287	
RE	OLD	0.0043498677	2026.05	-5.4376	7.6138	
RE	OLD	0.0043951332	4587.13	-5.4273	8.4310	
RE	OLD	0.0046094493	73036.68	-5.3796	11.1987	
RE	OLD	0.0046247477	2875.27	-5.3763	7.9639	
RE	OLD	0.0046555934	3279.62	-5.3697	8.0955	
RE	OLD	0.0047542941	5891.43	-5.3487	8.6813	
RE	OLD	0.0049436538	2135.71	-5.3097	7.6666	
RE	OLD	0.0049687260	9436.54	-5.3046	9.1523	
RE	OLD	0.0055770694	80485.19	-5.1891	11.2958	
RE	OLD	0.0059962681	19368.05	-5.1166	9.8714	
RE	OLD	0.0066867186	28552.82	-5.0076	10.2595	
RE	OLD	0.0073478291	129657.01	-4.9134	11.7726	
RE	OLD	0.0076182294	194.63	-4.8772	5.2711	
RE	OLD	0.0078722531	3118.82	-4.8444	8.0452	
BD	NEW	0.0079621021	9500.00	-4.8331	9.1590	
RE	OLD	0.0095095298	2553.37	-4.6555	7.8452	
RE	OLD	0.0102176741	44254.56	-4.5836	10.6977	
RE	OLD	0.0105761365	20652.95	-4.5492	9.9356	
RE	OLD	0.0126755860	960160.86	-4.3681	13.7749	

Table B-1-1. Bagging data used to develop the correlation equations

----- Equipment Type=VALVE Service=LL -----
 (continued)

Plant Type	Data Origin	Measured Emission Rate (kg/hr)	Screening Value (ppmv)	Natural Log of Emission Rate (kg/hr)	Natural Log of Screening Value (ppmv)	Outlier Flag
RE	OLD	0.0128994159	301945.80	-4.3506	12.6180	
RE	OLD	0.0134752877	28558.21	-4.3069	10.2597	
RE	OLD	0.0137156706	114.30	-4.2892	4.7388	
RE	OLD	0.0190054451	1649.34	-3.9630	7.4081	
RE	OLD	0.0194889771	518201.90	-3.9379	13.1581	
RE	OLD	0.0220373843	213772.09	-3.8150	12.2727	
RE	OLD	0.0220386022	7980.81	-3.8150	8.9848	
RE	OLD	0.0221003955	362645.26	-3.8122	12.8012	
RE	OLD	0.0248459751	9843.83	-3.6951	9.1946	
RE	OLD	0.0254155227	41862.00	-3.6724	10.6421	
RE	OLD	0.0263386824	659517.01	-3.6367	13.3993	
RE	OLD	0.0272779071	1399.25	-3.6017	7.2437	
RE	OLD	0.0283621432	288.41	-3.5627	5.6644	
RE	OLD	0.0283930499	352.85	-3.5616	5.8660	
RE	OLD	0.0293848208	480.98	-3.5273	6.1758	
RE	OLD	0.0303470196	562236.45	-3.4951	13.2397	
RE	OLD	0.0305360632	21853.55	-3.4888	9.9921	
RE	OLD	0.0372725448	122666.22	-3.2895	11.7172	
RE	OLD	0.0410821388	62573.58	-3.1922	11.0441	
RE	OLD	0.0468639667	393961.70	-3.0605	12.8840	
RE	OLD	0.0687821973	49473.43	-2.6768	10.8092	
RE	OLD	0.0713743302	36751.32	-2.6398	10.5119	
RE	OLD	0.0838252864	360547.09	-2.4790	12.7954	
RE	OLD	0.1027415340	53569.80	-2.2755	10.8887	
RE	OLD	0.2448798474	371111.15	-1.4070	12.8243	

N = 233 (1 outliers)

Table B-1-2. Comparison of regression results for the old, new, and combined bagging data sets.

Equipment Type/Service: Connectors/All	
Statistical Parameter	Data Used in Regression
	New
Number of data pairs	107
Regression intercept	-14.815
Regression slope	0.885
Regression R ²	0.525
Regression correlation coefficient	0.725
Regression mean square error	4.355
Regression root mean square error	2.087
Average ln screening value	3.472
Sum of squares of ln screening values	646.821
Scale bias correction factor	8.298
Correlation equation constant	3.05E-6

Equipment Type/Service: Pumps/Light Liquid			
Statistical Parameter	Data Used in Regression		
	Old ^a	New	Combined
Number of data pairs	51	68	117
Regression intercept	-12.827	-12.515	-12.142
Regression slope	0.865	0.907	0.824
Regression R ²	0.613	0.644	0.710
Regression correlation coefficient	0.783	0.803	0.842
Regression mean square error	2.246	3.783	2.591
Regression root mean square error	1.499	1.945	1.610
Average ln screening value	8.582	5.393	6.783
Sum of squares of ln screening values	233.223	548.793	1071.500
Scale bias correction factor	2.941	6.149	3.563
Correlation equation constant	7.91E-6	2.26E-5	1.90E-5

a Indicates that the parameter were derived from the digitized data pairs for the OLD regression.

Table B-1-2. (continued)

Equipment Type/Service: Valves/Gas

Statistical Parameter	Data Used in Regression		
	Old ^a	New	Combined
Number of data pairs	95	84	179
Regression intercept	-12.848	-14.936	-15.033
Regression slope	0.661	0.750	0.873
Regression R ²	0.359	0.516	0.715
Regression correlation coefficient	0.599	0.711	0.846
Regression mean square error	2.767	4.392	3.745
Regression root mean square error	1.663	2.096	1.935
Average ln screening value	8.823	3.691	6.415
Sum of squares of ln screening values	329.550	682.442	2186.020
Scale bias correction factor	3.858	8.311	6.315
Correlation equation constant	1.02E-5	2.71E-6	1.87E-6

^a Indicates that the parameter were derived from the digitized data pairs for the OLD regression.

Equipment Type/Service: Valves/Light Liquid

Statistical Parameter	Data Used in Regression		
	Old ^a	New	Combined
Number of data pairs	126	107	232
Regression intercept	-10.585	-14.137	-13.975
Regression slope	0.452	0.721	0.797
Regression R ²	0.194	0.502	0.677
Regression correlation coefficient	0.441	0.709	0.823
Regression mean square error	4.413	3.115	4.088
Regression root mean square error	2.101	1.765	2.022
Average ln screening value	8.978	3.300	6.345
Sum of squares of ln screening values	644.683	633.647	3110.310
Scale bias correction factor	8.608	4.580	7.520
Correlation equation constant	2.18E-4	3.32E-6	6.41E-6

^a indicates that the parameter were derived from the digitized data pairs for the OLD regression

APPENDIX B: ATTACHMENT 2

This attachment lists the data used to develop the default-zero emission leak rates in table B-2-1. Table B-2-2 lists summary information on the default-zero development.

Table B-2-1. Data used for default zero calculations.

-----Equipment Type=CONNECTORS Service=ALL-----

PLT_TYPE	Screening Value (ppmv)	Mass Emission Rate (kg/hr)	Natural Log of Mass Emission Rate (kg/hr)
EO	0.00	0.0000000475	-16.86331619
EO	0.00	0.0000000608	-16.61499543
EO	0.00	0.0000000613	-16.60715372
EO	0.00	0.0000000790	-16.35377339
EO	0.00	0.0000000988	-16.13056673
EO	0.00	0.0000001027	-16.09179287
BD	0.00	0.0000001033	-16.08517422
BD	0.00	0.0000001037	-16.08139097
EO	0.00	0.0000001065	-16.05508510
EO	0.00	0.0000001079	-16.04208307
EO	0.00	0.0000001085	-16.03689892
EO	0.00	0.0000001089	-16.03320436
EO	0.00	0.0000001112	-16.01231281
EO	0.00	0.0000001113	-16.01113856
EO	0.00	0.0000001115	-16.00911113
EO	0.00	0.0000001120	-16.00437388
EO	0.00	0.0000001125	-16.00075170
EO	0.00	0.0000001133	-15.99300732
EO	0.00	0.0000001146	-15.98221965
EO	0.00	0.0000001146	-15.98146212
EO	0.00	0.0000001150	-15.97834935
EO	0.00	0.0000001166	-15.96444127
EO	0.00	0.0000001176	-15.95559511
EO	0.00	0.0000001177	-15.95545662
EO	0.00	0.0000001178	-15.95391595
EO	0.00	0.0000001181	-15.95192362
EO	0.00	0.0000001189	-15.94478891
EO	0.00	0.0000001213	-15.92488652
EO	0.00	0.0000001234	-15.90745448
EO	0.00	0.0000001240	-15.90308275
EO	0.00	0.0000001296	-15.85882804
EO	0.00	0.0000001320	-15.84081663
BD	0.00	0.0000001349	-15.81855266
EO	0.00	0.0000001376	-15.79862472
EO	0.00	0.0000001390	-15.78899513
BD	0.00	0.0000001412	-15.77318199
EO	0.00	0.0000001413	-15.77244897
BD	0.00	0.0000001440	-15.75326730
BD	0.00	0.0000001446	-15.74929429
BD	0.00	0.0000001448	-15.74817023
BD	0.00	0.0000001454	-15.74382504
BD	0.00	0.0000001455	-15.74329360
BD	0.00	0.0000001485	-15.72271562
BD	0.00	0.0000001490	-15.71949421
BD	0.00	0.0000001497	-15.71483698
BD	0.00	0.0000001505	-15.70909501

Table B-2-1. Data used for default zero calculations.

----- Equipment Type=CONNECTORS Service=ALL -----
 (continued)

PLT_TYPE	Screening Value (ppmv)	Mass Emission Rate (kg/hr)	Natural Log of Mass Emission Rate (kg/hr)
EO	0.00	0.0000001511	-15.70514515
EO	0.00	0.0000001544	-15.68403336
BD	0.00	0.0000001547	-15.68204363
EO	0.00	0.0000001563	-15.67144879
BD	0.00	0.0000001573	-15.66508859
BD	0.00	0.0000001574	-15.66465227
BD	0.00	0.0000001596	-15.65073157
BD	0.00	0.0000001614	-15.63962500
BD	0.00	0.0000001621	-15.63500235
BD	0.00	0.0000001625	-15.63229582
EO	0.00	0.0000001631	-15.62914831
EO	0.00	0.0000001636	-15.62557049
EO	0.00	0.0000001641	-15.62273582
EO	0.00	0.0000001642	-15.62198449
EO	0.00	0.0000001648	-15.61837621
EO	0.00	0.0000001648	-15.61837621
EO	0.00	0.0000001650	-15.61705986
EO	0.00	0.0000001650	-15.61705962
EO	0.00	0.0000001651	-15.61656953
EO	0.00	0.0000001657	-15.61295101
EO	0.00	0.0000001657	-15.61295101
EO	0.00	0.0000001660	-15.61112981
EO	0.00	0.0000001688	-15.59463081
EO	0.00	0.0000001692	-15.59241662
EO	0.00	0.0000001717	-15.57752890
BD	0.00	0.0000001741	-15.56347827
BD	0.00	0.0000001747	-15.56001908
EO	0.00	0.0000001750	-15.55828552
EO	0.00	0.0000001807	-15.52620814
EO	0.00	0.0000001812	-15.52341721
BD	0.00	0.0000001904	-15.47417798
BD	0.00	0.0000001920	-15.46559058
BD	0.00	0.0000001932	-15.45958528
EO	0.00	0.0000001990	-15.43018880
EO	0.00	0.0000002086	-15.38283699
EO	0.00	0.0000002194	-15.33220908
EO	0.00	0.0000002431	-15.22964242
EO	0.00	0.0000002476	-15.21159451
EO	0.00	0.0000002508	-15.19874994
EO	0.00	0.0000002570	-15.17423032
BD	0.00	0.0000002585	-15.16823490
EO	0.00	0.0000002593	-15.16532554
BD	0.00	0.0000002594	-15.16500428
EO	0.00	0.0000002602	-15.16174131
EO	0.00	0.0000002607	-15.15994436

Table B-2-1. Data used for default zero calculations.

----- Equipment Type=CONNECTORS Service=ALL -----
 (continued)

PLT_TYPE	Screening Value (ppmv)	Mass Emission Rate (kg/hr)	Natural Log of Mass Emission Rate (kg/hr)
EO	0.00	0.0000002626	-15.15272411
EO	0.00	0.0000002626	-15.15272411
EO	0.00	0.0000002659	-15.13996186
EO	0.00	0.0000002664	-15.13812531
BD	0.00	0.0000002959	-15.03330632
EO	0.00	0.0000003055	-15.00115460
BD	0.00	0.0000003140	-14.97386313
EO	0.00	0.0000003276	-14.93133352
BD	0.00	0.0000003303	-14.92340849
BD	0.00	0.0000003315	-14.91955531
BD	0.00	0.0000003346	-14.91035517
BD	0.00	0.0000003436	-14.88372774
BD	0.00	0.0000003436	-14.88368692
BD	0.00	0.0000003442	-14.88192105
BD	0.00	0.0000003461	-14.87648133
BD	0.00	0.0000003504	-14.86410580
BD	0.00	0.0000003672	-14.81747447
BD	0.00	0.0000003946	-14.74527193
BD	0.00	0.0000004121	-14.70207785
EO	0.00	0.0000004133	-14.69904106
BD	0.00	0.0000004212	-14.68010001
EO	0.00	0.0000004468	-14.62113094
BD	0.00	0.0000004720	-14.56621062
EO	0.00	0.0000005089	-14.49108397
EO	0.00	0.0000005180	-14.47320006
EO	0.00	0.0000005187	-14.47197698
EO	0.00	0.0000005908	-14.34186784
EO	0.00	0.0000006166	-14.29899587
BD	0.00	0.0000006960	-14.17794549
EO	0.00	0.0000007110	-14.15652787
EO	0.00	0.0000007192	-14.14510177
EO	0.00	0.0000008267	-14.00581175
EO	0.00	0.0000009572	-13.85929011
EO	0.00	0.0000010002	-13.81535039
BD	0.00	0.0000010065	-13.80901606
EO	0.00	0.0000010071	-13.80841513
EO	0.00	0.0000011795	-13.65045667
EO	0.00	0.0000011927	-13.63931593
EO	0.00	0.0000021315	-13.05868377
BD	0.00	0.0000023492	-12.96141917
EO	0.00	0.0000024557	-12.91711588
BD	0.00	0.0000024895	-12.90342759
BD	0.00	0.0000025620	-12.87473675
BD	0.00	0.0000030901	-12.68731235
BD	0.00	0.0000033269	-12.61346713

Table B-2-1. Data used for default zero calculations.

----- Equipment Type=CONNECTORS Service=ALL -----
 (continued)

PLT_TYPE	Screening Value (ppmv)	Mass Emission Rate (kg/hr)	Natural Log of Mass Emission Rate (kg/hr)
BD	0.00	0.0000037589	-12.49138454
BD	0.00	0.0000040185	-12.42460572
BD	0.00	0.0000042414	-12.37062573
BD	0.00	0.0000044626	-12.31978282
BD	0.00	0.0000066833	-11.91589131
BD	0.00	0.0000075709	-11.79119727
BD	0.00	0.0000105577	-11.45865639
BD	0.00	0.0000144776	-11.14290744
BD	0.00	0.0000154005	-11.08111125
BD	0.00	0.0000165494	-11.00916328

N = 146

----- Equipment Type=PUMP Service=LL -----

PLT_TYPE	Screening Value (ppmv)	Mass Emission Rate (kg/hr)	Natural Log of Mass Emission Rate (kg/hr)
EO	0.00	0.0000002532	-15.18920187
EO	0.00	0.0000002674	-15.13444207
BD	0.00	0.0000003397	-14.89520337
BD	0.00	0.0000006493	-14.24738145
BD	0.00	0.0000013801	-13.49334976
BD	0.00	0.0000031715	-12.66130995
EO	0.00	0.0000061497	-11.99910617
BD	0.00	0.0000978267	-9.232313175

N = 8

Table B-2-1. Data used for default zero calculations.

----- Equipment Type=VALVE Service=G -----

PLT_TYPE	Screening Value (ppmv)	Mass Emission Rate (kg/hr)	Natural Log of Mass Emission Rate (kg/hr)
EO	0.00	0.0000000591	-16.64400086
EO	0.00	0.0000000722	-16.44327301
EO	0.00	0.0000000737	-16.42283692
EO	0.00	0.0000000786	-16.35920326
EO	0.00	0.0000000790	-16.35376554
EO	0.00	0.0000000796	-16.34647953
EO	0.00	0.0000001079	-16.04237697
EO	0.00	0.0000001081	-16.04053084
EO	0.00	0.0000001083	-16.03863245
EO	0.00	0.0000001312	-15.84631356
EO	0.00	0.0000001321	-15.83996505
EO	0.00	0.0000001325	-15.83639998
BD	0.00	0.0000001382	-15.79429751
BD	0.00	0.0000001436	-15.75651804
EO	0.00	0.0000001446	-15.74956966
BD	0.00	0.0000001516	-15.70207714
EO	0.00	0.0000001581	-15.65972752
BD	0.00	0.0000001595	-15.65122577
BD	0.00	0.0000001602	-15.64710329
EO	0.00	0.0000001750	-15.55828552
EO	0.00	0.0000002350	-15.26347692
BD	0.00	0.0000002539	-15.18638489
EO	0.00	0.0000002612	-15.15814418
BD	0.00	0.0000002633	-15.14979281
EO	0.00	0.0000002674	-15.13444207
BD	0.00	0.0000003272	-14.93266093
BD	0.00	0.0000003339	-14.91228255
EO	0.00	0.0000003878	-14.76283680
EO	0.00	0.0000004091	-14.70928502
BD	0.00	0.0000004607	-14.59056027
EO	0.00	0.0000006457	-14.25286952
BD	0.00	0.0000007014	-14.17014032
EO	0.00	0.0000009932	-13.82235860
BD	0.00	0.0000009955	-13.81999480
BD	0.00	0.0000022122	-13.02153380
BD	0.00	0.0000022562	-13.00184573
BD	0.00	0.0000025712	-12.87114036
BD	0.00	0.0000033699	-12.60062417
BD	0.00	0.0000044219	-12.32894306
BD	0.00	0.0000106176	-11.45299698

N = 40

Table B-2-1. Data used for default zero calculations.

----- Equipment Type=VALVE Service=LL -----

PLT_TYPE	Screening Value (ppmv)	Mass Emission Rate (kg/hr)	Natural Log of Mass Emission Rate (kg/hr)
EO	0.00	0.0000001121	-16.00352165
EO	0.00	0.0000001173	-15.95857877
EO	0.00	0.0000001211	-15.92634574
EO	0.00	0.0000001229	-15.91229458
EO	0.00	0.0000001337	-15.82756192
BD	0.00	0.0000001440	-15.75311308
BD	0.00	0.0000001461	-15.73913742
BD	0.00	0.0000001498	-15.71376221
BD	0.00	0.0000001503	-15.71042334
BD	0.00	0.0000001513	-15.70424314
EO	0.00	0.0000001642	-15.62246991
EO	0.00	0.0000001644	-15.62066973
EO	0.00	0.0000001644	-15.62066973
EO	0.00	0.0000001645	-15.62017964
EO	0.00	0.0000001648	-15.61837621
EO	0.00	0.0000001654	-15.61475957
EO	0.00	0.0000001656	-15.61343643
EO	0.00	0.0000001657	-15.61294634
EO	0.00	0.0000001660	-15.61112981
EO	0.00	0.0000001663	-15.60930997
BD	0.00	0.0000001669	-15.60596798
EO	0.00	0.0000001758	-15.55382679
EO	0.00	0.0000001758	-15.55382679
BD	0.00	0.0000001780	-15.54144504
BD	0.00	0.0000001804	-15.52802656
EO	0.00	0.0000001827	-15.51543605
BD	0.00	0.0000001853	-15.50155175
EO	0.00	0.0000002507	-15.19885548
EO	0.00	0.0000002568	-15.17511567
EO	0.00	0.0000002623	-15.15362868
EO	0.00	0.0000002645	-15.14545135
EO	0.00	0.0000002654	-15.14208066
EO	0.00	0.0000002657	-15.14094135
EO	0.00	0.0000002664	-15.13812531
EO	0.00	0.0000002750	-15.10635430
BD	0.00	0.0000002786	-15.09348218
BD	0.00	0.0000002807	-15.08603323
BD	0.00	0.0000002831	-15.07737541
BD	0.00	0.0000003292	-14.92670035
BD	0.00	0.0000003296	-14.92525863
BD	0.00	0.0000003327	-14.91592554
EO	0.00	0.0000003803	-14.78222371
EO	0.00	0.0000003997	-14.73266021
EO	0.00	0.0000004350	-14.64784669
EO	0.00	0.0000004933	-14.52205744
BD	0.00	0.0000005121	-14.48467228

Table B-2-1. Data used for default zero calculations.

----- Equipment Type=VALVE Service=LL -----
 (continued)

PLT_TYPE	Screening Value (ppmv)	Mass Emission Rate (kg/hr)	Natural Log of Mass Emission Rate (kg/hr)
EO	0.00	0.0000007099	-14.15820731
BD	0.00	0.0000011219	-13.70046348
BD	0.00	0.0000022380	-13.00992148
EO	0.00	0.0000028444	-12.77016392
BD	0.00	0.0000041389	-12.39507152
BD	0.00	0.0000053490	-12.13860411
EO	0.00	0.0000121637	-11.31705756

N = 53

Table B-2-2. Comparison of Default Zero Mass Emission Rates from the Original EPA Protocol and from the CMA/EPA EO/BD Study

Equipment Type	Service	Old Default Zero Emission Rate (kg/hr)	Results from CMA/EPA EO/BD Bagging Data Study					
			Number of Observations	Scale Bias Correction Factor	Revised Default Zero Emission Rate (kg/hr)	Lower 95% Confidence Limit	Default Zero Upper 95% Confidence Limit	Screening Value ^a (ppmv)
CONNEC	ALL	9.34E-5	146	2.06	6.12E-7	5.02E-7	7.45E-7	0.163
PUMP	LL	3.91E-5	8	4.73	7.49E-6	1.36E-6	4.11E-5	0.323
VALVE	G	3.31E-5	40	2.19	6.56E-7	4.35E-7	9.87E-7	0.301
VALVE	LL	4.52E-4	53	1.65	4.85E-7	3.67E-7	6.42E-7	0.039

^a The "default zero" screening value is the screening value that would result in emissions equal to the default zero mass emission rate when entered into the applicable correlation. The revised SOCOMI correlations were used to estimate the "default zero" screening values.

APPENDIX B: ATTACHMENT 3

This attachment summarizes information on each of the screening data sets. Table B-3-1 summarizes data used to revise the SOCFI emission factors. Figures B-3-1 through B-3-4 plot the screening value distributions for each data set.

Connectors

% of Sources

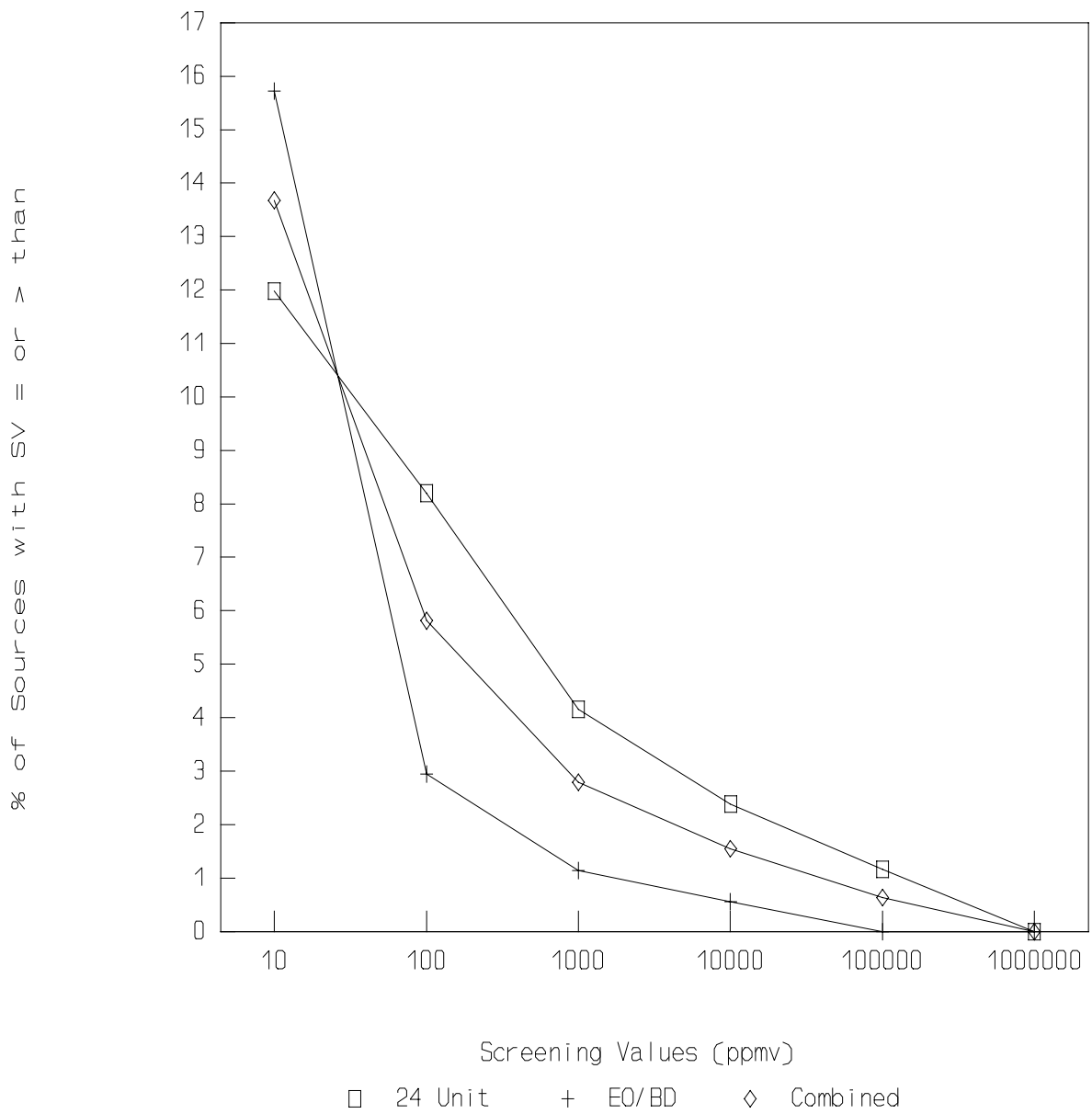

Figure B-3-1. Distribution of Connectors Screening Values for SOCMI

Light Liquid Pumps

% of Sources

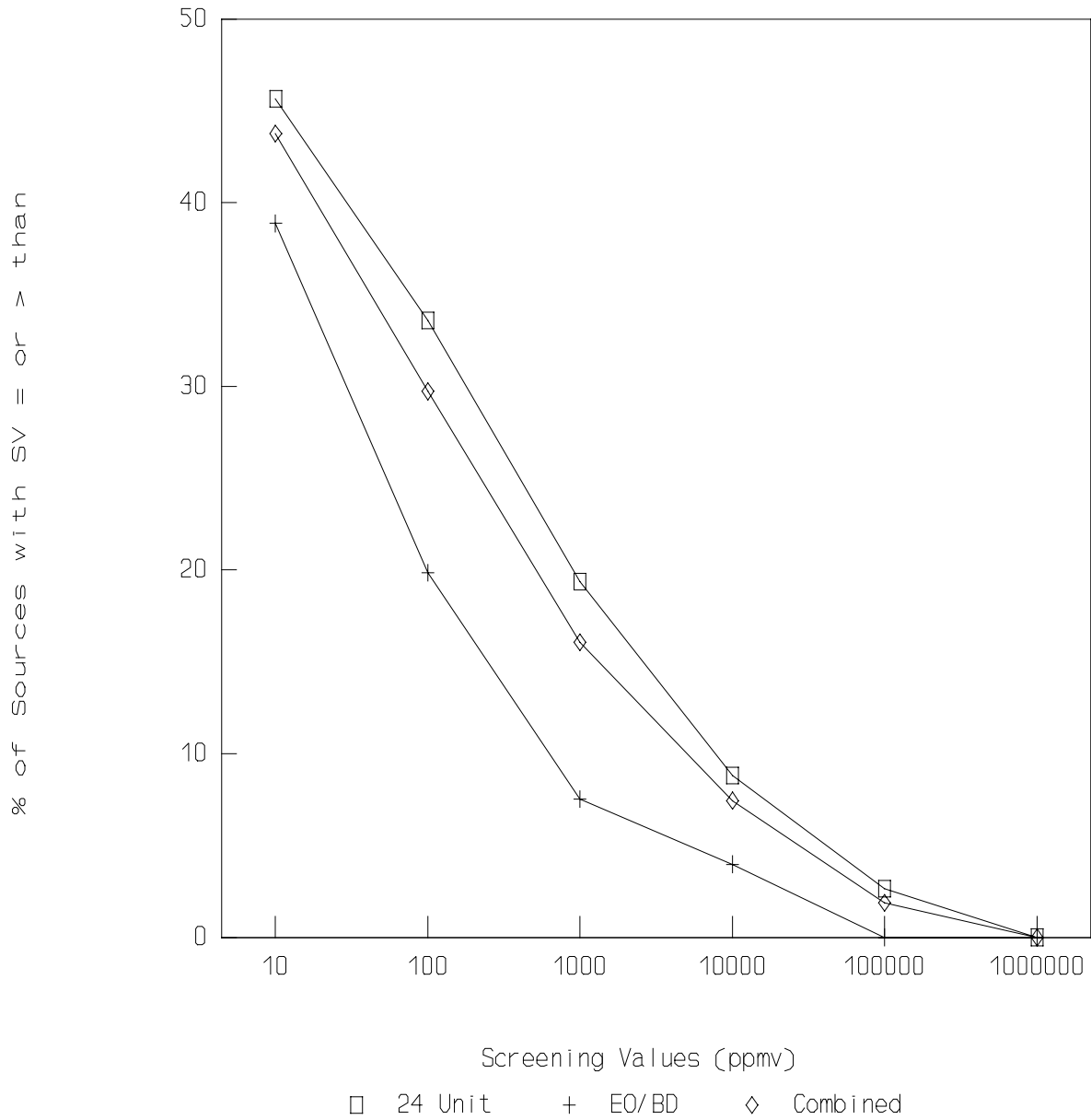

Figure B-3-2. Distribution of Light Liquid Pumps Screening Values for SOCMI

Gas Valves

% of Sources

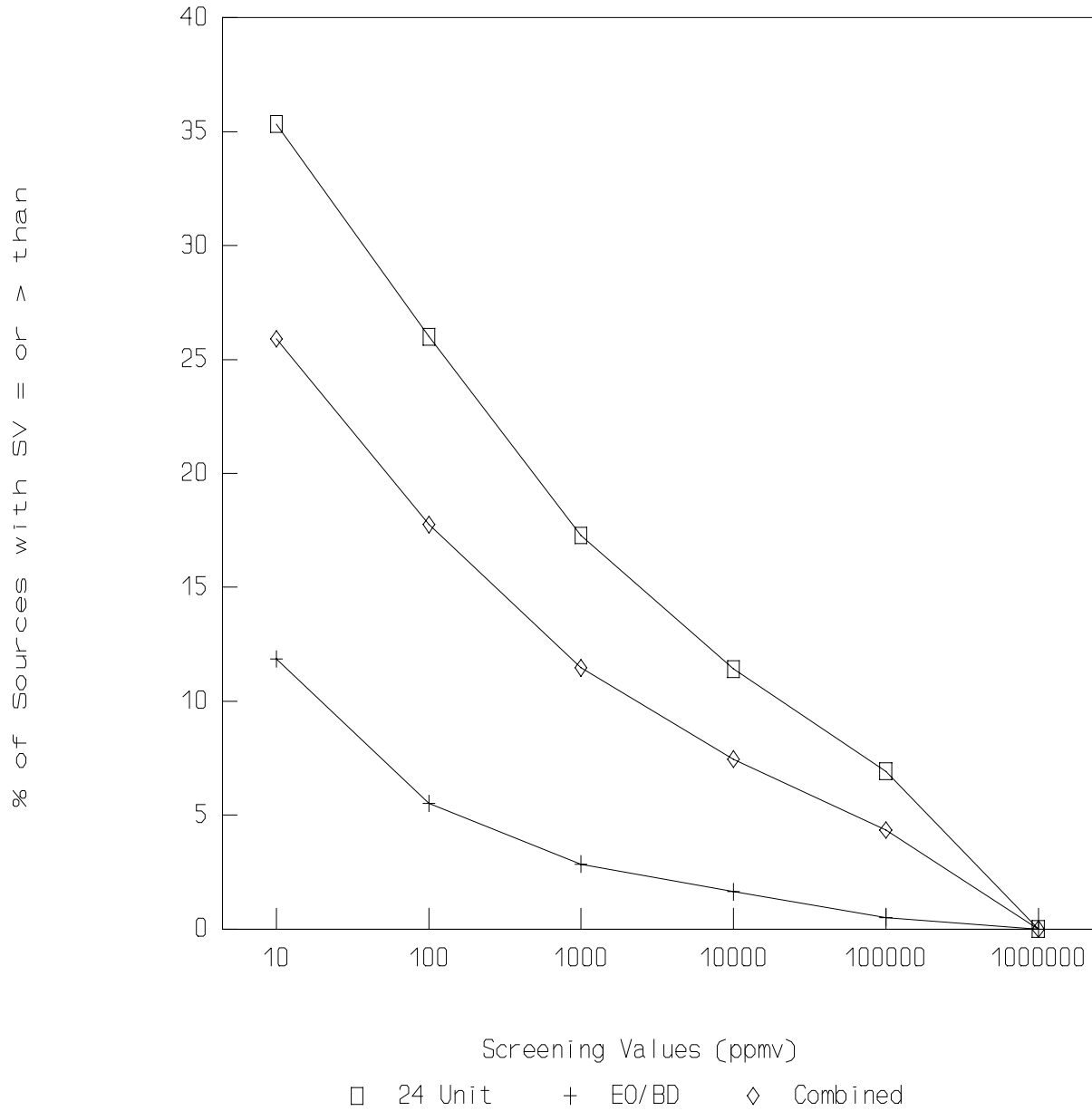

Figure B-3-3. Distributio of Gas Valves Screening Values for SOCM

Light Liquid Valves

% of Sources

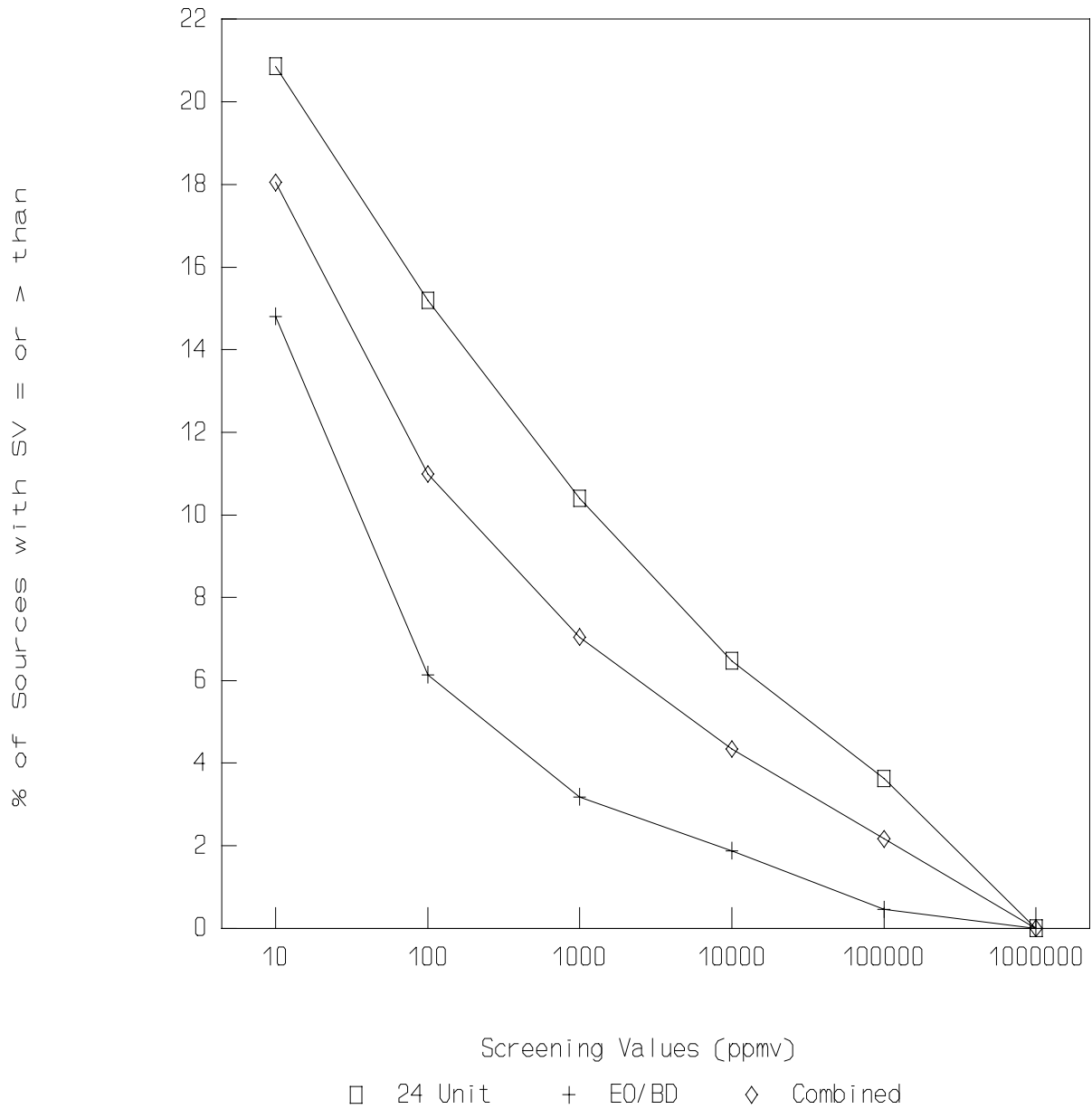

Figure B-3-4. Distribution of Light Liquid Valves Screening Values for SOCMI

Table B-3-1. Emission Factors Calculated From Revised SOCM I Correlation Equations.

Screening data set	Equipment type	Phase	Old emission factor (kg/hr)	Total number of screening values	Average nonzero emission rate (kg/hr)	Number of zero screening values	Default zero emission rate (kg/hr)	Average emission factor (kg/hr)
24 UNIT	CONNEC	ALL	8.30E-04	4,283	2.50E-02	3,740	6.12E-07	3.16E-03
24 UNIT	PUMP	LL	4.94E-02	646	5.36E-02	335	7.45E-06	2.58E-02
24 UNIT	VALVE	G	5.60E-03	9,669	2.47E-02	5,962	6.56E-07	9.45E-03
24 UNIT	VALVE	LL	7.10E-03	18,300	2.99E-02	14,292	4.85E-07	6.55E-03
EO/BD	CONNEC	ALL	8.30E-04	3,562	3.76E-04	1,381	6.12E-07	2.30E-04
EO/BD	PUMP	LL	4.94E-02	252	7.12E-03	85	7.45E-06	4.72E-03
EO/BD	VALVE	G	5.60E-03	6,507	2.83E-03	4,685	6.56E-07	7.92E-04
EO/BD	VALVE	LL	7.10E-03	15,810	3.26E-03	10,429	4.85E-07	1.11E-03
COMBINED	CONNEC	ALL	8.30E-04	7,845	5.28E-03	5,121	6.12E-07	1.83E-03 ^a
COMBINED	PUMP	LL	4.94E-02	898	3.73E-02	420	7.45E-06	1.99E-02 ^a
COMBINED	VALVE	G	5.60E-03	16,176	1.75E-02	10,647	6.56E-07	5.97E-03 ^a
COMBINED	VALVE	LL	7.10E-03	34,110	1.46E-02	24,721	4.85E-07	4.03E-03 ^a

^a These average emission factors are the revised SOCM I average emission factors.

APPENDIX C:

Revision of Petroleum Industry Correlations and Emission Factors

APPENDIX C

The purpose of this appendix is to provide background information on the data collection and analysis performed to revise the petroleum industry (refineries, marketing terminals, and oil and gas production operations) correlations and to develop marketing terminal and oil and gas production operation average emission factors. Section C.1 addresses the following:

- Comparison of old (1980) and new (1993) refinery data;
- Development of revised petroleum industry correlation equations, default zero emission rates, and pegged emission rates;
- Summary of petroleum industry correlation parameters; and
- Development of marketing terminal and oil and gas production operation average emission factors.

The figures for this section appear at the end of section C.1.

Several attachments that list all of the data are also included for this appendix. Attachment 1 lists the bagging data used to develop the correlation equations, attachment 2 lists the bagging data used to develop pegged emission rates, attachment 3 lists the bagging data used to develop default zero emission rates, and attachment 4 summarizes the screening data for average emission factors.

C.1 DEVELOPMENT OF REVISED PETROLEUM INDUSTRY CORRELATIONS AND FACTORS

During the early-1990's, new petroleum industry equipment leak data were collected and analyzed. The Western States Petroleum Association (WSPA) and the American Petroleum Institute (API) jointly commissioned the 1994 refinery equipment leak report¹ to evaluate fugitive emissions at petroleum refineries. The API also commissioned the 1993 marketing terminal equipment leak report,² and, along with the Gas Research Institute (GRI), jointly commissioned the 1993 oil and gas production operations reports.^{3,4} These data are referred to in this discussion as the 1993 petroleum industry data. In contrast to the data collected during the late-1970's for the 1980 refinery report⁵ (these are referred to in this discussion as the 1980 refinery data) which came from uncontrolled facilities and were used to develop correlations and emission factors that appear in previous

versions of this protocol, the 1993 petroleum industry data came from controlled facilities and were collected using current procedures that are considered state of the art for the 1990's.

The purpose of this section is to explain how and why the 1993 data were used to update the petroleum industry correlations and to present the data that were used in this update. The conclusions presented in this section were based on a combination of engineering judgement and quantitative statistical analysis of the available emission data. Judgments were made based on an understanding of possible mechanisms of equipment leak emissions and qualitative assessment of the data. A more detailed explanation of the analyses highlighted in this section appear in a technical memorandum⁶ that is available on EPA's electronic bulletin board.⁷

C.1.1 Overview of Data Analysis

Based on guidelines presented in chapter 4 of this document, the quality control/quality assurance (QC/QA) procedures for data collection and laboratory analysis of the 1993 petroleum industry data were evaluated and found to be of sufficient quality for the development of correlations. However, a few data pairs were excluded from correlation development due to large background concentrations or high screening value variability. Several options were considered for using the 1993 petroleum industry equipment leak data, including:

- Combine the 1980 refinery data and the 1993 refinery data to develop revised refinery correlations and, based on 1993 data, provide separate new correlations for marketing terminals and oil and gas production operations.
- Combine the 1980 refinery data with the 1993 refinery, marketing terminal, and oil and gas production data to develop new petroleum industry correlations that apply to all three industry segments.
- Drop the 1980 data and correlations from further use. Combine the 1993 refinery, marketing terminal, and oil and gas production operations data to develop a single correlation that applies to all three industry segments or keep the three industry segment correlations separate.

Judgments based upon an understanding of equipment leak emission mechanisms and a qualitative assessment of the data were used in conjunction with the following visual comparisons and statistical tests, that quantitatively evaluate the similarities or differences between the data being compared, to assess the options listed above:

- Visual comparison of the plotted data, regression lines, and 95 percent confidence intervals for the regression lines, to identify general characteristics of the data and to put the results of statistical tests into perspective.
- F-test for the mean square error (MSE) differences between the regression equations, to compare the variability of the errors of the predictions.
- T-tests for intercept (b_0) and slope (b_1) differences between the regression equations, to determine whether the regressions were statistically different. If the t-test for the intercepts indicated similarities, but the t-test for the slopes indicated differences or vice versa, the regressions were considered statistically different. However, when both the intercept and slope t-tests indicated similarities, the regressions were considered statistically the same.
- Mass verification analysis. Because of the statistical requirement for normality of the data distributions for the above tests to be valid, the visual and statistical tests were evaluated in log-log space (i.e., the mathematical space that results when regressing the natural logarithm of the mass emission rate against the natural logarithm of the screening value). The mass verification analysis was conducted to assess the impact of the correlations on the nontransformed data. The total measured mass was compared to the total mass predicted from each of the industry segment correlations and from the combined correlations. Mass ratios (the ratio of the total predicted mass to the total measured mass) formed the basis for evaluating the results. The mass verification was considered good when mass ratio was close to 1.0, indicating that the predicted mass was close to the measured mass (a mass ratio of 1.0 indicates a perfect prediction because the predicted mass equals the measured mass).

C.1.2 Comparison of the 1993 Refinery Data with the 1980 Refinery Data

The 1980 refinery data were collected and analyzed in the laboratory using procedures that were not as stringent as the current procedures. Thus, the 1993 refinery data are of better quality than the 1980 data, as evaluated by today's standards.

Also, the 1980 data were screened with a TLV calibrated with hexane and the 1993 refinery data were screened with an OVA calibrated with methane. Thus, any comparisons between the two datasets must be made on a common basis. The conversion from TLV to OVA is not totally clear or understood. Multiple conversion equations exist and the TLV/OVA relationship changes at different screening levels. Also, the TLV and OVA use different methods to obtain measurements that give different results for the same data. This difficulty was overcome sufficiently to perform a crude comparison; however no adjustments could be made to compare both datasets on a common basis with regards to data quality. The following relationship (taken from Figure C3-18a)⁸ was used to approximate an OVA-methane screening value from a TLV-hexane screening value:

$$SV_{\text{OVA-methane}} = 10^C \quad (\text{C-1})$$

where:

$SV_{\text{OVA-methane}}$ = screening value taken with OVA-methane

$$C = \frac{[\log_{10}(SV_{\text{TLV-hexane}}) + 0.193]}{0.952}$$

$SV_{\text{TLV-hexane}}$ = screening value taken with TLV-hexane.

However, this transformation was achieved in the 1993 refinery report¹ using another conversion equation (from the 1979 valve screening report⁹) that gave results that were different from those obtained using Equation C-1 above, thereby emphasizing the uncertainty that exists for any of the transformations from TLV to OVA.

Additionally, pegged data were identified in the 1980 dataset and removed prior to comparisons with the 1993 refinery

data, because separate emission rates are now calculated for pegged readings. Thus, the 1980 correlations were adjusted for screening instrument (TLV) and pegged data. Using available screening data from 17 marketing terminals as an example, the adjusted 1980 correlations gave estimations of total facility emissions that ranged between 42% to 116% of the total facility emissions obtained from the published 1980 correlations. The adjusted 1980 correlations gave an estimation of the total emissions from all 17 marketing terminals that were 61% of the total emissions estimated from the published 1980 correlations.

The comparisons between the 1980 refinery data and the 1993 refinery data were made for matching equipment types/services. The following four equipment types/services were compared: all connectors, light liquid pumps, gas valves, and light liquid valves. Plots that compare the raw data, the regression lines, and the 95 percent confidence intervals of the regression lines for the 1980 and 1993 refinery data were constructed for the four equipment types/services. The plot for all connector data, which illustrates the largest visual differences, is shown in Figure C-1 and the plot for gas valve data, which illustrates the smallest visual differences, is shown in figure c-2. All of the plots revealed a general separation of data pairs and 95 percent confidence intervals of the regression lines, thereby suggesting that there were differences between the 1980 and 1993 refinery data.

The results of the statistical tests (not shown) for differences between the 1980 and 1993 refinery regressions indicated that the regression lines were different because statistically significant differences between the 1980 refinery data and the 1993 refinery data existed for both the slope and intercept for all equipment types/services. Figure C-3 shows the ratios of predicted to measured mass that were calculated from the 1980 refinery data, the 1993 refinery data, and the combined 1980/1993 refinery data (a predicted to measured mass ratio of 1.0 would indicate a perfect prediction). In all cases, either the combined correlation or the 1993 refinery correlation did a

better job of predicting the total mass of the 1980 refinery data than did the 1980 correlation, and the 1993 refinery correlation always gave the best mass ratios for the 1993 refinery data. The ratios of predicted to measured mass using the combined 1980/1993 refinery correlations were further from 1.0 than those obtained individually with either the 1980 or 1993 refinery correlations for the respective datasets, and thus, a rather poor verification of the combined correlation was indicated.

Based on the above results, the 1980 refinery data were not used to develop the revised correlations that are presented in this revised version of the protocol.

C.1.3 Comparison of the 1993 Refinery Data, the 1993 Marketing Terminal Data, and the 1993 Oil and Gas Production Operations Data

An underlying concern with all of the comparisons discussed in this section was the relatively small sample size for most of the equipment types/services. This problem was also encountered in the 1980 refinery report.⁵ Table C-1 shows the sample size for each equipment type/service for the 1993 refinery data, the 1993 marketing terminal data, and the 1993 oil and gas production operations data that were deemed suitable for correlation development. (For comparative purposes, the corresponding sample sizes from the 1980 refinery analysis⁵ are footnoted in Table C-1.) The sample size was 30 or larger for only 9 of the 46 equipment types/services for which data were collected. It is recommended in chapter 2 that the sample size should be 30 or larger for the development of correlations. In addition, the sample size was 10 or less for 23 of the 46 equipment types/services. Sample sizes that are this small may produce results of only limited usefulness and meaning.

Two-way statistical comparisons were made between the 1993 refinery, marketing terminal, and oil and gas production operations data for equipment types/services where data were collected. All comparisons were service-specific. The following equipment types/services were compared: light liquid connectors, light liquid flanges, light liquid open-ended lines, light liquid

TABLE C-1. SUMMARY OF THE SAMPLE SIZE FOR EACH EQUIPMENT TYPE/SERVICE FOR THE 1993 REFINERY DATA, THE 1993 MARKETING TERMINAL DATA, AND THE 1993 OIL AND GAS PRODUCTION OPERATIONS DATA

Equipment Type	Stream Service	Sample Size			Total
		1993 Refinery Data	1993 Marketing Terminal Data	1993 Oil & Gas Production Operations Data	
Connector	Gas	8	2	24	34
	Heavy Liquid	2	0	1	3
	Light Liquid	18	21	42	81
Flange	Gas	4	1	9	14
	Heavy Liquid	1	0	1	2
	Light Liquid	15	12	13	40
Instrument ^a	Gas	0	0	2	2
	Light Liquid	0	0	1	1
Loading Arm ^a	Gas	0	7	0	7
	Light Liquid	0	16	0	16
Open-Ended Line	Gas	7	0	48	55
	Heavy Liquid	3	0	13	16
	Light Liquid	15	16	39	70
Other ^a	Gas	0	1	0	1
	Light Liquid	0	3	0	1
Pressure Relief Valve ^a	Gas	1	0	6	7
	Light Liquid	1	0	3	4
Pump	Heavy Liquid	11	0	0	11
	Light Liquid	30	11	1	42
Stuffing Box ^a	Heavy Liquid	0	0	11	11
	Light Liquid	0	0	12	12
Valve	Gas	50	2	84	136
	Heavy Liquid	22	0	1	23
	Light Liquid	82	45	51	178
Vent ^a	Gas	0	0	3	3
	Light Liquid	0	0	3	3
1993 Petroleum Industry Total		270	137	368	775
1980 Refinery Total ^b					678

^a Components with small sample sizes will be grouped together to form an "OTHERS" category.

^b For comparative purposes, sample sizes from the 1980 refinery report are: all flanges-52; light liquid pumps-259, gas valves-79; light liquid valves-119; valves and compressors in hydrogen service-47; all drains-61; and heavy liquid pumps-61.

pumps, gas valves, and light liquid valves.

Plots that compare the 1993 refinery, marketing terminal, and oil and gas production operations raw data, regression lines, and 95 percent confidence intervals for the regression lines were constructed for all equipment types/services listed above. The plot for light liquid flange data, which illustrates the largest visual differences, is shown in Figure C-4 and the plot for light liquid valve data, which illustrates the smallest visual differences, is shown in Figure C-5. In general, all of the data plots revealed a general intermingling of data pairs from the three petroleum industry segments and an overlapping of 95 percent confidence intervals of the regression lines. No clear separation of petroleum industry segments was evident in most of the data plots.

The results of the statistical tests (not shown) for two-way differences between regressions for the petroleum industry segment datasets indicated statistically significant differences for all of the equipment types/services; however, the visual plots indicated that these differences may be too small to really be relevant, especially when compared to the magnitude of the differences between the 1980 and 1993 refinery data.

Figure C-6 presents the ratios of predicted to measured mass that were calculated from the 1993 refinery, marketing terminal, and oil and gas production operations data. The mass ratios from facility type-specific correlations for the predictions that were closest to 1.0 for a given facility type dataset were usually from the correlation based on another facility type. For example, for light liquid valves, the marketing terminal correlation gave a mass ratio of 1.06 for the refinery data, whereas the refinery correlation gave a mass ratio of 1.50 for the refinery data.

In several cases, the combined petroleum industry correlation gave an even closer ratio of predicted to measured mass than any of the individual facility type-specific correlations. For example, for light liquid flanges, the combined correlation gave a mass ratio of 0.94 for the marketing

terminal data, which is better than the 1.34 obtained when using the marketing terminal correlation. Overall, the combined 1993 petroleum industry correlations gave mass ratios ranging between 0.10 and 2.85 for facility type-specific datasets. The mass ratios using the combined correlations to predict the total mass of the combined dataset ranged between 0.28 and 1.42 for all equipment types/services. Thus, the ratios of predicted to measured mass obtained from the combined 1993 petroleum industry correlations were closer to 1.0 than those obtained individually with facility type-specific correlations, thus supporting the combination of data from the three petroleum industry segments.

It is not surprising that the visual and statistical results showed similarities between the petroleum industry segment datasets because the three industry segments produce similar products of similar molecular weights, viscosities, and densities. Therefore the leak mechanisms and screening instrument response rates are not expected to be different between the industry segments. Although some small differences were identified, there is not compelling evidence to believe that these differences were large enough to be real or meaningful.

C.1.4 Development of the Combined Refinery/Marketing Terminal/Oil and Gas Production Operations Correlations, Default Zero Emission Rates, and Pegged Emission Rates

Based on the results presented in the above section, the 1993 refinery, marketing terminal data, and oil and gas production operations data were combined to develop petroleum industry correlations using the procedures outlined in chapter 2 and appendix B. Due to the small sample size for some equipment types, an "others" category was developed to provide a correlation for cases not otherwise covered. The equipment types flagged in Table C-1 (instruments, loading arms, other, pressure relief valves, stuffing boxes, and vents, compressors, and dump lever arms) were combined to form this "other" equipment type.

The visual and statistical tests for differences between regression equations were applied to the combined dataset to aid in the decision of what equipment type(s)/service(s), if any, to

combine for developing the correlations. Visual inspection of the data plots (not shown) revealed that the gas, light liquid, and heavy liquid service data were generally well intermingled. The p-values from the t-tests for b_0 and b_1 differences indicated that the services were statistically similar only for gas/heavy liquid open-ended lines and for gas/light liquid open-ended lines. However, most of the statistically significant differences appeared too small in the visual plots to really be relevant. As with the comparisons between the refinery, marketing terminal, and oil and gas production operations data, the mass verification analysis for the services showed that when differences were identified for the service comparisons, they were small, thereby lending support towards combining the data. Other factors that support combining services include:

- The leak mechanism is the same regardless of service. However, screening value distributions, which affect total emissions (not correlations), may be different for each service.
- When services were segregated, sample sizes for nearly all equipment types were less than 30, the sample size recommended in chapter 2 for developing correlations, even after combining all of the petroleum industry segment data. Combination of data from all services increased the sample size to above 30 for nearly all equipment types.
- The importance of the component service was investigated in the 1994 refinery report,¹ using additional statistical tests. The analyses of variance that were presented in the refinery report showed that services should be combined because there were no statistically significant differences between the correlations for different services for a given equipment type.

The visual analysis that was conducted to compare the regression equations for the different equipment types revealed that the raw data for the different equipment types were well intermingled for some equipment types and separated for other types. However, a stacking of regression lines and confidence intervals was evident, such that some equations overlapped (connectors and open-ended lines), but there were rather large differences between other equations (pumps versus connectors). Thus, in contrast to other comparisons, where the differences

were either consistently large (1980 versus 1993 refinery data) or small (1993 petroleum industry segment data), differences between the equipment types varied. Based on the visual results, it was felt that further analysis outside the objectives of this study was necessary to determine which equipment types to combine. Therefore, the equipment types remained segregated.

Correlations, default zero emission rates, and pegged emission rates were developed from the combined 1993 refinery, marketing terminal, and oil and gas production operations data for combined services for connectors, flanges, open-ended lines, pumps, valves, and "other" equipment types. Table C-2 shows the regression statistics for correlations. The R^2 values ranged from 0.32 for "others" to 0.54 for valves, thereby indicating that the equations were capable of predicting about half of the variability of the mass emission rates. These R^2 values corresponded to correlation coefficients (r , the square root of R^2) ranging from 0.57 to 0.73. Although these R^2 values were sometimes less than those obtained for individual facility/service types, they were more consistent across equipment types than the R^2 values for the individual facility/service types which ranged from 0.04 to 0.75. These R^2 values revealed the inherent limits of this tool for predicting mass emission rates (an inability to account for 25% to 50% of the mass emission variance) and were not substantially different from those shown in other reports.^{1,2,3,5} Table C-3 shows the petroleum industry correlations, default zero emission rates, and pegged emission rates for each equipment type as calculated from the combined 1993 refinery, marketing terminal, and oil and gas production operations data.

Emission estimates from the revised correlations depend on the distribution of equipment types and screening values at a given facility. Comparisons of the results obtained from the 1993 correlations and previously published correlations can vary greatly from facility-to-facility. For screening data that contained a large number of low screening values from 17 marketing terminals, the 1993 correlations gave estimations of

TABLE C-2. REGRESSION STATISTICS FOR THE COMBINED 1993 REFINERY, MARKETING TERMINAL, AND OIL AND GAS PRODUCTION OPERATIONS DATA

Equipment Type/ Service	Number of Data Pairs	Intercept (b ₀)	Slope (b ₁)	Coefficient of Simple Determinati on (R ²)	Standard Error of Estimate	Mean ln Screening Value ^a	Sum of Squared Differences ^b	Scale Bias Correction Factor (SBCF)	Half-Width of the 95% Confidence Interval ^c
Valve/All	337	-14.169	0.746	0.54	1.544	6.477	1705.07	3.27	0.17
Connector/All	118	-14.893	0.735	0.47	1.754	6.214	592.09	4.51	0.32
Pump/All	53	-11.546	0.610	0.46	1.856	5.816	409.21	5.15	0.51
Other ^d /All	70	-12.838	0.589	0.32	1.843	5.437	316.36	5.14	0.44
Flange/All	56	-13.788	0.703	0.37	1.771	5.767	204.71	4.48	0.47
Open-Ended Line/All	141	-14.658	0.704	0.44	1.823	6.166	745.97	5.11	0.30

^aThe mean ln screening value is the average of all of the ln screening values:

$$\bar{X} = (1/n) \times \sum(X_i)$$

^bThe sum of squared differences refers to the difference between the individual ln screening values and the average ln screening value: $\sum(X_i - \bar{X})^2$. (The mean ln screening value and the sum of squared differences are used to calculate confidence intervals.)

^cThe half-width of the 95 percent confidence interval is calculated using the mean ln screening value as the X-value being evaluated in the confidence interval calculation.

^dThe "other" equipment type includes instruments, loading arms, pressure relief valves, stuffing boxes, vents, compressors, and dump lever arms.

TABLE C-3. CORRELATION EQUATIONS, DEFAULT ZERO EMISSION RATES, AND PEGGED EMISSION RATES FOR PREDICTING TOTAL ORGANIC COMPOUND EMISSIONS FROM THE COMBINED 1993 REFINERY, MARKETING TERMINAL, AND OIL AND GAS PRODUCTION OPERATIONS DATA^a

Equipment Type/Service	Default Zero Emission Rate (kg/hr/source) ^b	Pegged Emission Rates (kg/hr/source) ^c		Correlation Equation ^d (kg/hr/source)
		10,000 ppmv	100,000 ppmv	
Valve/All	7.8E-06	0.064	0.140	LEAK = 2.29E-06×(SV) ^{0.746}
Pump/All	2.4E-05	0.074	0.160 ^e	LEAK = 5.03E-05×(SV) ^{0.610}
Other ^f /All	4.0E-06	0.073	0.110	LEAK = 1.36E-05×(SV) ^{0.589}
Connector/All	7.5E-06	0.028	0.030	LEAK = 1.53E-06×(SV) ^{0.735}
Flange/All	3.1E-07	0.085	0.084	LEAK = 4.61E-06×(SV) ^{0.703}
Open-Ended Line/All	2.0E-06	0.030	0.079	LEAK = 2.20E-06×(SV) ^{0.704}

^aTo estimate emissions: use the default zero emission rates only when the screening value (adjusted for background) equals 0.0 ppmv; otherwise use the correlation equations. If the monitoring device registers a pegged value, use the appropriate pegged emission rate.

^bDefault zero emission rates were based on the combined 1993 refinery and marketing terminal data only (default zero data were not collected from oil and gas production facilities).

^cThe 10,000 ppmv pegged emission rate was based on components screened at greater than 10,000 ppmv; however, in some cases, most of the data could have come from components screened at greater than 100,000 ppmv, thereby resulting in similar pegged emission rates for both the 10,000 and 100,000 ppmv levels (e.g., connector and flanges).

^dLEAK is the predicted mass emission rate (kg/hr) and SV is the screening value (ppmv) measured by the monitoring device.

^eOnly 2 data points were available for the pump 100,000 ppmv pegged emission rate; therefore the ratio of the pump 10,000 ppmv pegged emission rate to the overall 10,000 ppmv pegged emission rate was multiplied by the overall 100,000 ppmv pegged emission rate to approximate the pump 100,000 ppmv pegged emission rate.

^fThe "other" equipment type was developed from instruments, loading arms, pressure relief devices, stuffing boxes, vents, compressors, dump lever arms, diaphragms, drains, hatches, meters, and polished rods. This "other" equipment type could be applied to any equipment other than connectors, flanges, open-ended lines, pumps or valves.

the total facility emissions that ranged from less than 10% to over 800% of the total facility emissions obtained from the adjusted 1980 correlations presented in this paper. When the total emissions from all 17 marketing terminals were evaluated, the 1993 correlations gave an estimate that was 40% of the total estimated by the adjusted 1980 correlations. Though the 17 marketing terminals do not represent the entire petroleum industry, these results illustrate the differences encountered when comparing emission estimates for individual facilities versus evaluating all facilities as a single group.

C.1.4 Marketing Terminal and Oil and Gas Production Operation Screening Data for Development of Average Emission Factors

Screening data from 17 marketing terminals¹⁰ and from 24 oil and gas production operation facilities^{11,12} were available to EPA for the development of average emission factors using the same procedures as discussed in appendix B.2.3 for the revision of SOCFI average factors. Attachment 4 to appendix C summarizes the screening data used to develop the emission factors.

Little documentation is available for the marketing terminal data because the data were collected and delivered directly to EPA with no formal report being written. The marketing terminal emission factors (shown in Tables 2-3 and 2-7) represent emissions from uncontrolled facilities.

The following five facility types were represented in the oil and gas production operations screening dataset:

- light crude facilities,
- heavy crude facilities,
- gas plants,
- gas production facilities, and
- offshore facilities.

The 24 oil and gas production operations facilities generally represent uncontrolled facilities, however, a couple of gas plants have agency-mandated inspection and maintenance programs. Anecdotal data were available regarding the control level at other facilities. A statistical analysis revealed that there were no significant differences between emission factors for those groups of sites with some form of inspection and

maintenance program versus those sites with no such programs¹³. Thus, the oil and gas production operations emission factors (shown in Tables 2-4 and 2-8) represent emissions from uncontrolled facilities.

REFERENCES

1. 1993 Study of Refinery Fugitive Emissions from Equipment Leaks, Volumes I, II, and III, Radian DCN No. 93-209-081-02, Radian Corporation, Prepared for Western States Petroleum Association, Glendale, CA, and American Petroleum Institute, Washington, D.C., 1994.
2. Development of Fugitive Emission Factors and Emission Profiles for Petroleum Marketing Terminals, Volumes I and II, API 4588, Radian Corporation, Prepared for American Petroleum Institute, 1993.
3. Fugitive Hydrocarbon Emissions from Oil and Gas Production Operations, API 4589, Star Environmental, Prepared for American Petroleum Institute, 1993.
4. Emission Factors for Oil and Gas Production Operations, API 4615, Star Environmental, Prepared for American Petroleum Institute, 1995.
5. Assessment of Atmospheric Emissions from Petroleum Refining, EPA-600/2-80-075., U.S. Environmental Protection Agency, Research Triangle Park, NC, 1980.
6. Petroleum Industry Equipment Leaks: Revised Correlations, Default Zero Emission Rates, and Pegged Emission Rates for Estimating VOC Emissions, Developed from 1993 Data from Refineries, Marketing Terminals, and Oil and Gas Production Operations, technical memorandum from David Epperson, Radian Corporation/Research Triangle Park, to David Markwordt, US EPA/OAQPS, January 27, 1995.
7. Technology Transfer Network (Electronic Bulletin Boards), Office of Air Quality Planning and Standards, U.S. Environmental Protection Agency, Research Triangle Park, NC, help desk phone number: (919) 541-5384, 1-5 pm EST.
8. Assessment of Atmospheric Emissions from Petroleum Refining: Volume 4, Appendix C, EPA-600/2-80-075d, U.S. Environmental Protection Agency, Research Triangle Park, NC, 1980.
9. Valve Screening Study at Six San Francisco Bay Area Petroleum Refineries, Radian DCN No. 79-219-370-05. Radian Corporation, Prepared for the United States Environmental Protection Agency, Research Triangle Park, NC, 1979.
10. Letter from Robert Strieter, API, to David Markwordt, U.S. EPA, regarding the submittal of gasoline distribution facility fugitive equipment screening data. April 26, 1994.
11. Fugitive Hydrocarbon Emissions from Oil and Gas Production Operations, API 4589, Star Environmental, Prepared for American Petroleum Institute, 1993.

12. Emission Factors for Oil and Gas Production Operations, API 4615, Star Environmental, Prepared for American Petroleum Institute, 1995.

13. Fax to Eric Peterson, Santa Barbara APCD, Santa Barbara, CA from G.E. Harris, Radian/Austin, August 31, 1995.

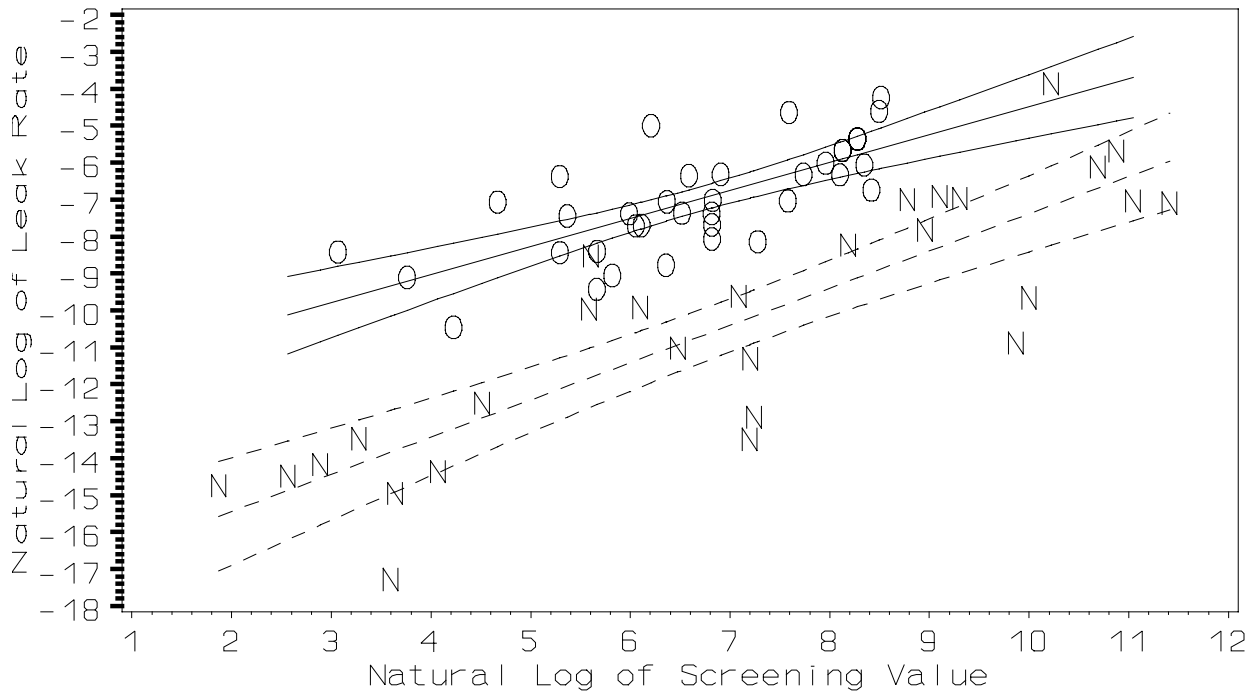

Figure C-1. Plot of data and regression lines with 95 percent confidence intervals for the all connector data from the 1980 (solid lines for regression equations and confidence bounds; O for individual data points) and 1993 (dashed lines for regression equations and confidence bounds; N for individual data points) refinery reports (screening values are in ppmv and leak rates in kg/hr).

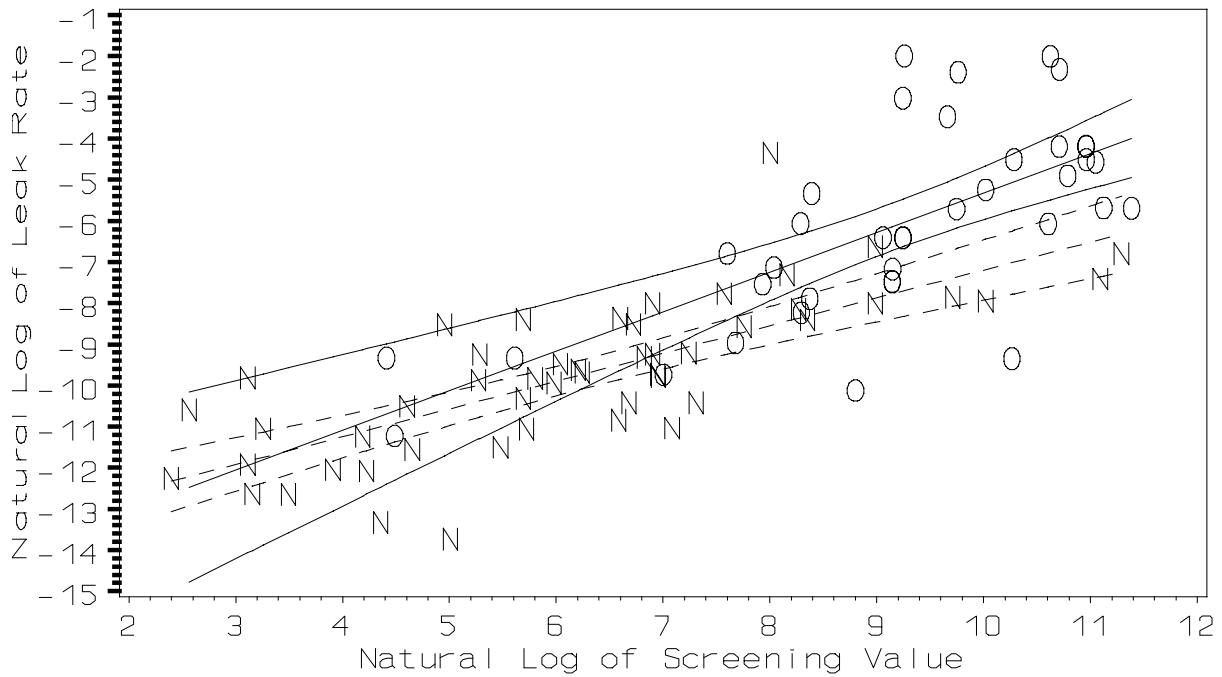

Figure C-2. Plot of data and regression lines with 95 percent confidence intervals for the gas valve data from the 1980 (solid lines for regression equations and confidence bounds; O for individual data points) and 1993 (dashed lines for regression equations and confidence bounds; N for individual data points) refinery reports (screening values are in ppmv and leak rates in kg/hr).

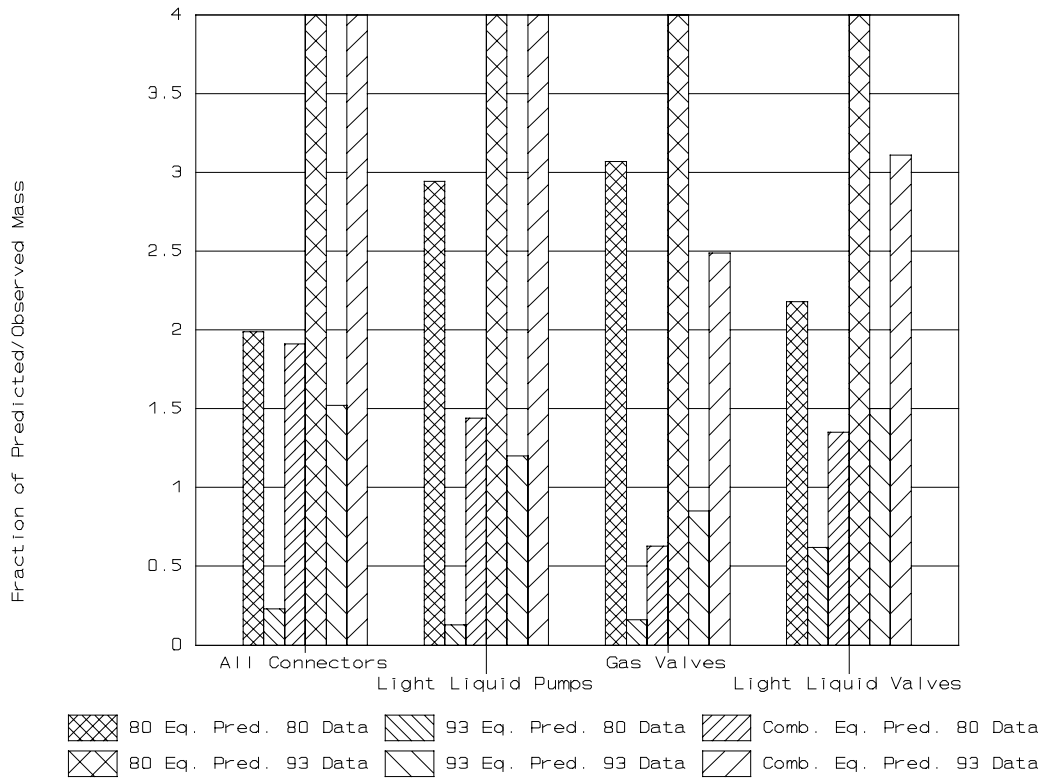

Figure C-3. Comparison of ratios of predicted to measured mass for the 1980 refinery, the 1993 refinery, and the combined 1980/1993 refinery data (a predicted-to-measured mass ratio of 1.0 indicates a perfect prediction). Bars that reach 4.0 on the chart actually extend beyond 4.0.

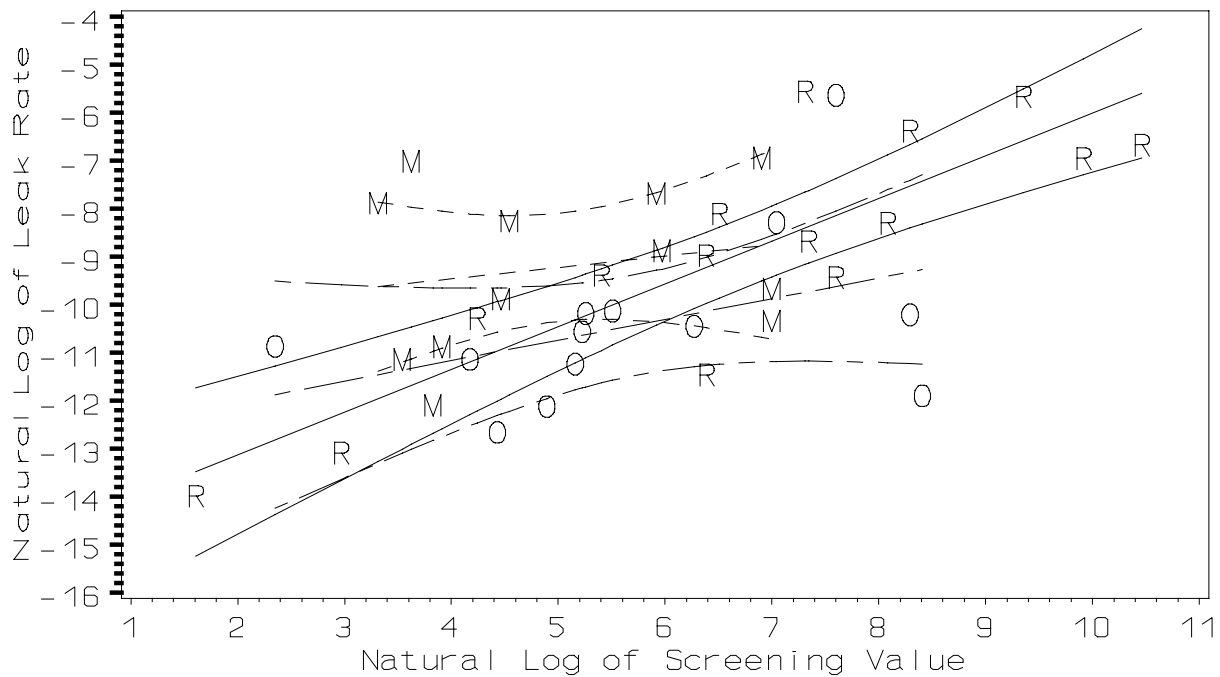

Figure C-4. Plot of data and regression lines with 95 percent confidence intervals for the light liquid flange data from the 1993 refinery (solid lines for regression equations and confidence bounds; R for individual data points), the 1993 marketing terminal (short dashed lines for regression equations and confidence bounds; M for individual data points), and the 1993 oil and gas production operations (alternating short and long dashed lines for regression equations and confidence bounds; M for individual data points) reports (screening values are in ppmv and leak rates in kg/hr).

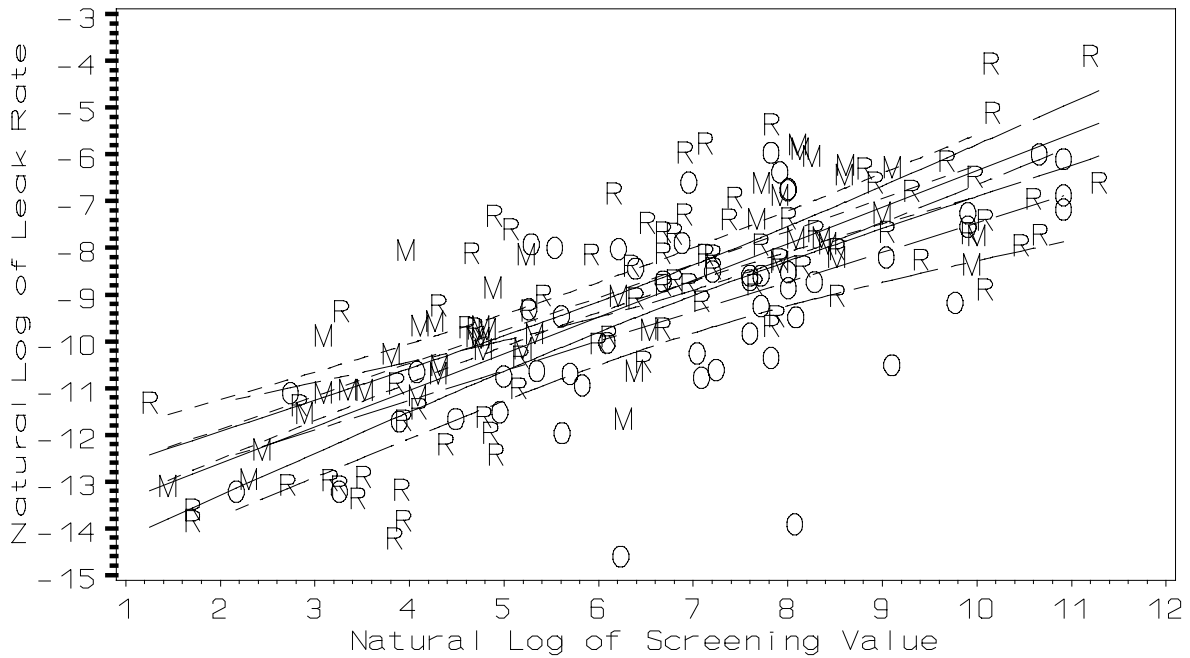

Figure C-5. Plot of data and regression lines with 95 percent confidence intervals for the light liquid valve data from the 1993 refinery (solid lines for regression equations and confidence bounds; R for individual data points), the 1993 marketing terminal (short dashed lines for regression equations and confidence bounds; M for individual data points), and the 1993 oil and gas production operations (alternating short and long dashed lines for regression equations and confidence bounds; M for individual data points) reports (screening values are in ppmv and leak rates in kg/hr).

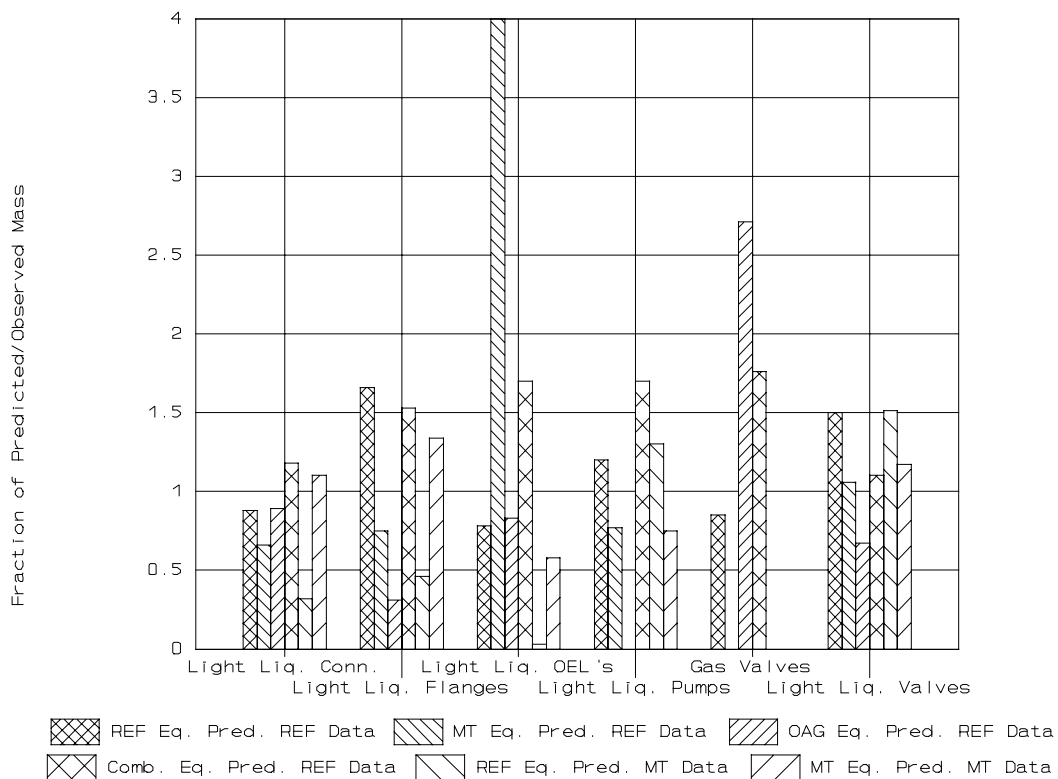

Figure C-6. Comparison of the ratios of predicted to observed mass from the 1993 refinery, marketing terminal, oil and gas production operations, and the combined refinery/marketing terminal/oil and gas production operations data (a predicted-to-measured mass ratio of 1.0 indicates a perfect prediction). Bars that reach 4.0 on the chart actually extend beyond 4.0.

APPENDIX C: ATTACHMENT 1

This attachment lists the bagging data used to develop the correlation equations for each of the equipment types in table C-1-1. Also included is a summary table (table C-1-2) of the regression statistics for the 1993 refinery, marketing terminal and oil and gas production operations data individually. Note that the regression statistics presented in table C-1-2 are based on the development of the regression lines using natural logarithms of the leak rates and screening values. Table C-1-3 lists the bagging data for the 1980 refinery data while table C-1-4 presents regression statistics for the 1980 and 1993 refinery data sets.

TABLE C-1-1. BAGGING DATA USED TO DEVELOP CORRELATION EQUATIONS

----- Equipment Type=CONNECTOR SERVICE=G -----

Plant Type	Measured Emission Rate(kg/hr)	Screening Value (ppmv)	Natural Log of Emission Rate (kg/hr)	Natural Log of Screening Value (ppmv)
ONOFF	0.00000045360	8.00	-14.606	2.079
REF	0.00000050826	13.00	-14.492	2.565
ONOFF	0.00000181439	1.75	-13.220	0.560
ONOFF	0.00000272158	106.00	-12.814	4.663
ONOFF	0.00000272158	145.00	-12.814	4.977
ONOFF	0.00000453597	70.00	-12.303	4.248
ONOFF	0.00000498957	98.00	-12.208	4.585
ONOFF	0.00000498957	1,045.00	-12.208	6.952
ONOFF	0.00000680396	1,450.00	-11.898	7.279
ONOFF	0.00000725755	440.00	-11.833	6.087
ONOFF	0.00001043273	195.00	-11.471	5.273
ONOFF	0.00001360791	6,240.00	-11.205	8.739
ONOFF	0.00001632949	4,982.00	-11.023	8.514
MT	0.00001732831	30.00	-10.963	3.401
ONOFF	0.00001995827	93.00	-10.822	4.533
ONOFF	0.00002313345	43.00	-10.674	3.761
ONOFF	0.00002903021	890.00	-10.447	6.791
ONOFF	0.00002993740	549.00	-10.416	6.308
ONOFF	0.00003084460	130.50	-10.387	4.871
REF	0.00004677946	267.00	-9.970	5.587
REF	0.00004909734	446.00	-9.922	6.100
REF	0.00006622970	1,196.50	-9.622	7.087
ONOFF	0.00010659530	2,742.00	-9.146	7.916
ONOFF	0.00013245033	1,999.00	-8.929	7.600
ONOFF	0.00014061508	1,985.00	-8.869	7.593
REF	0.00019757326	271.00	-8.529	5.602
MT	0.00027662615	30.00	-8.193	3.401
ONOFF	0.00033566180	790.00	-7.999	6.672
REF	0.00039860292	7,745.00	-7.828	8.955
ONOFF	0.00046040098	3,996.00	-7.683	8.293
ONOFF	0.00049850313	5,498.00	-7.604	8.612
REF	0.00094198494	10,995.00	-6.968	9.305
ONOFF	0.00105688107	8,995.00	-6.852	9.104
REF	0.00220312075	43,995.00	-6.118	10.692

N = 34

TABLE C-1-1. BAGGING DATA USED TO DEVELOP CORRELATION EQUATIONS
(CONTINUED)

Table C-1-1. Bagging Data Used to Develop Correlation Equations

----- Equipment Type=CONNECTOR SERVICE=HL -----

Plant Type	Measured Emission Rate(kg/hr)	Screening Value (ppmv)	Natural Log of Emission Rate (kg/hr)	Natural Log of Screening Value (ppmv)
REF	0.00000057407	58.50	-14.371	4.069
ONOFF	0.00001360791	19.50	-11.205	2.970
REF	0.00098339835	8,994.00	-6.924	9.104

N = 3

----- Equipment Type=CONNECTOR SERVICE=LL -----

Plant Type	Measured Emission Rate(kg/hr)	Screening Value (ppmv)	Natural Log of Emission Rate (kg/hr)	Natural Log of Screening Value (ppmv)
REF	0.00000003124	36.50	-17.282	3.597
REF	0.00000032133	38.00	-14.951	3.638
REF	0.00000039502	6.50	-14.744	1.872
ONOFF	0.00000045360	13.50	-14.606	2.603
REF	0.00000069890	18.00	-14.174	2.890
REF	0.00000138429	1,335.00	-13.490	7.197
REF	0.00000140733	26.50	-13.474	3.277
ONOFF	0.00000226799	1,547.00	-12.997	7.344
REF	0.00000252558	1,393.00	-12.889	7.239
ONOFF	0.00000272158	20.00	-12.814	2.996
ONOFF	0.00000272158	41.00	-12.814	3.714
ONOFF	0.00000272158	155.00	-12.814	5.043
ONOFF	0.00000272158	498.00	-12.814	6.211
ONOFF	0.00000362878	75.00	-12.527	4.317
REF	0.00000366230	91.00	-12.517	4.511
ONOFF	0.00000408237	56.00	-12.409	4.025
ONOFF	0.00000408237	96.00	-12.409	4.564
MT	0.00000418117	35.00	-12.385	3.555
ONOFF	0.00000544316	157.50	-12.121	5.059
ONOFF	0.00000589676	200.00	-12.041	5.298
ONOFF	0.00000635036	290.00	-11.967	5.670
ONOFF	0.00000680396	39.00	-11.898	3.664
ONOFF	0.00000816475	4,400.00	-11.716	8.389
MT	0.00001033612	317.00	-11.480	5.759
ONOFF	0.00001133993	294.00	-11.387	5.684
ONOFF	0.00001133993	1,240.00	-11.387	7.123
REF	0.00001226163	1,345.50	-11.309	7.205
ONOFF	0.00001270072	123.00	-11.274	4.812
MT	0.00001529121	23.00	-11.088	3.135
ONOFF	0.00001542230	322.00	-11.080	5.775

TABLE C-1-1. BAGGING DATA USED TO DEVELOP CORRELATION EQUATIONS
(CONTINUED)

Table C-1-1. Bagging Data Used to Develop Correlation Equations

----- Equipment Type=CONNECTOR SERVICE=LL -----
(continued)

Plant Type	Measured Emission Rate (kg/hr)	Screening Value (ppmv)	Natural Log of Emission Rate (kg/hr)	Natural Log of Screening Value (ppmv)
ONOFF	0.00001542230	395.00	-11.080	5.979
MT	0.00001610768	23.00	-11.036	3.135
REF	0.00001628413	649.00	-11.025	6.475
ONOFF	0.00001814388	56.00	-10.917	4.025
REF	0.00001880613	19,304.00	-10.881	9.868
ONOFF	0.00002222625	945.00	-10.714	6.851
ONOFF	0.00002267985	825.00	-10.694	6.715
ONOFF	0.00002313345	5,900.00	-10.674	8.683
ONOFF	0.00002585503	172.00	-10.563	5.147
MT	0.00002609816	45.00	-10.554	3.807
MT	0.00002844053	321.00	-10.468	5.771
ONOFF	0.00002993740	121.00	-10.416	4.796
ONOFF	0.00003356618	450.00	-10.302	6.109
MT	0.00003923025	42.50	-10.146	3.750
MT	0.00004271251	670.00	-10.061	6.507
MT	0.00004451148	446.50	-10.020	6.101
MT	0.00004481675	542.00	-10.013	6.295
ONOFF	0.00005080287	6,930.00	-9.888	8.844
ONOFF	0.00005216366	1,996.00	-9.861	7.599
MT	0.00005430464	112.00	-9.821	4.718
MT	0.00005460855	96.00	-9.815	4.564
ONOFF	0.00006304999	3,248.00	-9.672	8.086
REF	0.00006329946	21,996.00	-9.668	9.999
MT	0.00006931416	141.50	-9.577	4.952
MT	0.00008792071	511.00	-9.339	6.236
ONOFF	0.00009570897	8,450.00	-9.254	9.042
ONOFF	0.00010886329	1,245.00	-9.125	7.127
ONOFF	0.00011612084	3,495.00	-9.061	8.159
ONOFF	0.00012247120	1,900.00	-9.008	7.550
ONOFF	0.00013381112	6,998.00	-8.919	8.853
MT	0.00013952191	420.00	-8.877	6.040
ONOFF	0.00018461399	2,992.00	-8.597	8.004
MT	0.00021457407	621.50	-8.447	6.432
ONOFF	0.00021863377	5,990.00	-8.428	8.698
MT	0.00025722126	41.00	-8.266	3.714
ONOFF	0.00026263268	1,249.00	-8.245	7.130
REF	0.00026441985	3,595.50	-8.238	8.187
MT	0.00030734827	270.00	-8.088	5.598
MT	0.00031839790	171.50	-8.052	5.145
ONOFF	0.00032341468	1,993.00	-8.037	7.597
ONOFF	0.00033475460	2,240.00	-8.002	7.714
ONOFF	0.00041640207	290.00	-7.784	5.670
MT	0.00071681938	6,996.00	-7.241	8.853
MT	0.00075932142	940.00	-7.183	6.846

TABLE C-1-1. BAGGING DATA USED TO DEVELOP CORRELATION EQUATIONS
(CONTINUED)

Table C-1-1. Bagging Data Used to Develop Correlation Equations

----- Equipment Type=CONNECTOR SERVICE=LL -----
(continued)

Plant Type	Measured Emission Rate(kg/hr)	Screening Value (ppmv)	Natural Log of Emission Rate (kg/hr)	Natural Log of Screening Value (ppmv)
REF	0.00082713417	89,996.50	-7.098	11.408
REF	0.00087190420	62,482.50	-7.045	11.043
REF	0.00090365599	6,492.50	-7.009	8.778
ONOFF	0.00152363240	2,490.00	-6.487	7.820
REF	0.00337970607	52,843.00	-5.690	10.875
REF	0.02082463939	27,493.00	-3.872	10.222
ONOFF	0.15713462760	44,990.00	-1.851	10.714

N = 81

----- Equipment Type=FLANGE SERVICE=G -----

Plant Type	Measured Emission Rate(kg/hr)	Screening Value (ppmv)	Natural Log of Emission Rate (kg/hr)	Natural Log of Screening Value (ppmv)
REF	0.00000133929	344.50	-13.523	5.842
ONOFF	0.00000272158	46.00	-12.814	3.829
REF	0.00000347791	97.00	-12.569	4.575
MT	0.00000944344	37.50	-11.570	3.624
ONOFF	0.00000952554	122.00	-11.562	4.804
ONOFF	0.00001133993	398.00	-11.387	5.986
ONOFF	0.00003220539	597.00	-10.343	6.392
REF	0.00003784088	81.00	-10.182	4.394
ONOFF	0.00003810215	39.00	-10.175	3.664
ONOFF	0.00005533884	197.00	-9.802	5.283
ONOFF	0.00007076114	1,996.00	-9.556	7.599
ONOFF	0.00054068765	424.00	-7.523	6.050
REF	0.00268479543	4,996.00	-5.920	8.516
ONOFF	0.00444751882	999.00	-5.415	6.907

N = 14

TABLE C-1-1. BAGGING DATA USED TO DEVELOP CORRELATION EQUATIONS
(CONTINUED)

Table C-1-1. Bagging Data Used to Develop Correlation Equations

----- Equipment Type=FLANGE SERVICE=HL -----

Plant Type	Measured Emission Rate(kg/hr)	Screening Value (ppmv)	Natural Log of Emission Rate (kg/hr)	Natural Log of Screening Value (ppmv)
REF	0.00000585594	22.50	-12.048	3.114
ONOFF	0.00000907194	345.00	-11.610	5.844

N = 2

TABLE C-1-1. BAGGING DATA USED TO DEVELOP CORRELATION EQUATIONS
(CONTINUED)

Table C-1-1. Bagging Data Used to Develop Correlation Equations

----- Equipment Type=FLANGE SERVICE=LL -----

Plant Type	Measured Emission Rate(kg/hr)	Screening Value (ppmv)	Natural Log of Emission Rate (kg/hr)	Natural Log of Screening Value (ppmv)
REF	0.00000084061	5.00	-13.989	1.609
REF	0.00000206056	19.50	-13.093	2.970
ONOFF	0.00000317518	84.00	-12.660	4.431
ONOFF	0.00000544316	133.50	-12.121	4.894
MT	0.00000558151	46.00	-12.096	3.829
ONOFF	0.00000680396	4,480.00	-11.898	8.407
REF	0.00001045859	595.50	-11.468	6.389
ONOFF	0.00001315431	174.00	-11.239	5.159
MT	0.00001445342	34.50	-11.145	3.541
ONOFF	0.00001451510	65.00	-11.140	4.174
MT	0.00001889096	50.00	-10.877	3.912
ONOFF	0.00001905108	10.50	-10.868	2.351
ONOFF	0.00002585503	186.00	-10.563	5.226
ONOFF	0.00002903021	530.00	-10.447	6.273
MT	0.00003226209	1,096.50	-10.342	7.000
REF	0.00003390230	69.50	-10.292	4.241
ONOFF	0.00003674136	3,997.00	-10.212	8.293
ONOFF	0.00003764855	192.00	-10.187	5.257
ONOFF	0.00003991654	247.00	-10.129	5.509
MT	0.00005107956	87.00	-9.882	4.466
MT	0.00006298648	1,096.50	-9.673	7.000
REF	0.00007970607	1,996.00	-9.437	7.599
REF	0.00008327588	222.50	-9.393	5.405
REF	0.00012617255	593.00	-8.978	6.385
MT	0.00013896398	392.00	-8.881	5.971
REF	0.00016897850	1,548.00	-8.686	7.345
REF	0.00024779098	3,244.50	-8.303	8.085
ONOFF	0.00025129275	1,145.00	-8.289	7.043
MT	0.00025963440	94.00	-8.256	4.543
REF	0.00030001361	671.00	-8.112	6.509
MT	0.00037563277	27.50	-7.887	3.314
MT	0.00046017418	372.50	-7.684	5.920
MT	0.00090079833	37.50	-7.012	3.624
REF	0.00095309807	20,246.00	-6.956	9.916
MT	0.00096566271	997.00	-6.943	6.905
REF	0.00125641840	34,995.50	-6.679	10.463
REF	0.00169028395	3,997.50	-6.383	8.293
REF	0.00344683843	11,547.00	-5.670	9.354
ONOFF	0.00355030391	1,998.00	-5.641	7.600
REF	0.00382985576	1,495.00	-5.565	7.310

N = 40

TABLE C-1-1. BAGGING DATA USED TO DEVELOP CORRELATION EQUATIONS
(CONTINUED)

Table C-1-1. Bagging Data Used to Develop Correlation Equations

----- Equipment Type=INSTRUMENT SERVICE=G -----

Plant Type	Measured Emission Rate(kg/hr)	Screening Value (ppmv)	Natural Log of Emission Rate (kg/hr)	Natural Log of Screening Value (ppmv)
ONOFF	0.00007302912	1,992.00	-9.525	7.597
ONOFF	0.00028259095	29,998.00	-8.172	10.309

N = 2

----- Equipment Type=INSTRUMENT SERVICE=LL -----

Plant Type	Measured Emission Rate(kg/hr)	Screening Value (ppmv)	Natural Log of Emission Rate (kg/hr)	Natural Log of Screening Value (ppmv)
ONOFF	0.00000272158	2,743.00	-12.814	7.917

N = 1

----- Equipment Type=LOADARM SERVICE=G -----

Plant Type	Measured Emission Rate(kg/hr)	Screening Value (ppmv)	Natural Log of Emission Rate (kg/hr)	Natural Log of Screening Value (ppmv)
MT	0.00000641205	18.00	-11.957	2.890
MT	0.00002664338	45.00	-10.533	3.807
MT	0.00007439445	70.00	-9.506	4.248
MT	0.00036316339	19.50	-7.921	2.970
MT	0.00134378118	2,498.50	-6.612	7.823
MT	0.00294180350	387.00	-5.829	5.958
MT	0.00397654903	1,096.00	-5.527	6.999

N = 7

TABLE C-1-1. BAGGING DATA USED TO DEVELOP CORRELATION EQUATIONS
(CONTINUED)

Table C-1-1. Bagging Data Used to Develop Correlation Equations

----- Equipment Type=LOADARM SERVICE=LL -----

Plant Type	Measured Emission Rate(kg/hr)	Screening Value (ppmv)	Natural Log of Emission Rate (kg/hr)	Natural Log of Screening Value (ppmv)
MT	0.00000263449	3.00	-12.847	1.099
MT	0.00000483852	75.00	-12.239	4.317
MT	0.00000647374	76.00	-11.948	4.331
MT	0.00001007893	6.00	-11.505	1.792
MT	0.00001144289	4.50	-11.378	1.504
MT	0.00001305906	5.50	-11.246	1.705
MT	0.00001802640	33.00	-10.924	3.497
MT	0.00001825229	6.00	-10.911	1.792
MT	0.00002585775	79.00	-10.563	4.369
MT	0.00002943210	26.50	-10.433	3.277
MT	0.00004225755	46.50	-10.072	3.839
MT	0.00005778372	15.00	-9.759	2.708
MT	0.00007896671	70.00	-9.446	4.248
MT	0.00010795156	96.00	-9.134	4.564
MT	0.00012671233	10.50	-8.974	2.351
MT	0.00021594394	145.50	-8.440	4.980

N = 16

TABLE C-1-1. BAGGING DATA USED TO DEVELOP CORRELATION EQUATIONS
(CONTINUED)

Table C-1-1. Bagging Data Used to Develop Correlation Equations

----- Equipment Type=OEL SERVICE=G -----

Plant Type	Measured Emission Rate(kg/hr)	Screening Value (ppmv)	Natural Log of Emission Rate (kg/hr)	Natural Log of Screening Value (ppmv)
REF	0.00000077642	20.30	-14.069	3.011
ONOFF	0.00000090719	9.00	-13.913	2.197
ONOFF	0.00000136079	8.00	-13.507	2.079
REF	0.00000177710	60.50	-13.241	4.103
ONOFF	0.00000181439	20.50	-13.220	3.020
ONOFF	0.00000181439	26.50	-13.220	3.277
ONOFF	0.00000181439	30.50	-13.220	3.418
ONOFF	0.00000226799	84.00	-12.997	4.431
ONOFF	0.00000272158	48.00	-12.814	3.871
ONOFF	0.00000272158	195.00	-12.814	5.273
ONOFF	0.00000272158	63.00	-12.814	4.143
ONOFF	0.00000272158	113.50	-12.814	4.732
ONOFF	0.00000362878	440.00	-12.527	6.087
ONOFF	0.00000362878	499.00	-12.527	6.213
REF	0.00000391912	16.50	-12.450	2.803
ONOFF	0.00000408237	546.00	-12.409	6.303
ONOFF	0.00000453597	377.00	-12.303	5.932
ONOFF	0.00000498957	59.00	-12.208	4.078
ONOFF	0.00000544316	24.00	-12.121	3.178
ONOFF	0.00000544316	930.00	-12.121	6.835
ONOFF	0.00000589676	755.00	-12.041	6.627
ONOFF	0.00000771115	65.00	-11.773	4.174
ONOFF	0.00000861834	740.00	-11.662	6.607
ONOFF	0.00000907194	383.00	-11.610	5.948
ONOFF	0.00001043273	600.00	-11.471	6.397
ONOFF	0.00001088633	4,430.00	-11.428	8.396
ONOFF	0.00001133993	250.00	-11.387	5.521
REF	0.00001313209	893.00	-11.240	6.795
ONOFF	0.00001587590	349.00	-11.051	5.855
ONOFF	0.00001859748	2,725.00	-10.892	7.910
ONOFF	0.00002177266	1,745.00	-10.735	7.465
ONOFF	0.00002812302	1,747.00	-10.479	7.466
ONOFF	0.00002857661	1,143.00	-10.463	7.041
ONOFF	0.00003039100	1,400.00	-10.401	7.244
REF	0.00003324186	1,295.00	-10.312	7.166
ONOFF	0.00003447337	1,845.00	-10.275	7.520
REF	0.00004146875	15,068.00	-10.091	9.620
ONOFF	0.00004853488	17,499.00	-9.933	9.770
ONOFF	0.00007166833	820.00	-9.543	6.709
ONOFF	0.00008845142	483.50	-9.333	6.181
ONOFF	0.00010024494	170.00	-9.208	5.136
ONOFF	0.00012065681	1,043.00	-9.023	6.950
ONOFF	0.00013743990	3,400.00	-8.892	8.132
ONOFF	0.00016057335	999.00	-8.737	6.907
ONOFF	0.00016737730	80.00	-8.695	4.382

TABLE C-1-1. BAGGING DATA USED TO DEVELOP CORRELATION EQUATIONS
(CONTINUED)

Table C-1-1. Bagging Data Used to Develop Correlation Equations

----- Equipment Type=OEL SERVICE=G -----
(continued)

Plant Type	Measured Emission Rate(kg/hr)	Screening Value (ppmv)	Natural Log of Emission Rate (kg/hr)	Natural Log of Screening Value (ppmv)
ONOFF	0.00020729384	3,746.00	-8.481	8.228
ONOFF	0.00025991109	849.00	-8.255	6.744
ONOFF	0.00029257008	13,497.00	-8.137	9.510
ONOFF	0.00043046358	1,980.00	-7.751	7.591
ONOFF	0.00057652182	27,497.00	-7.458	10.222
ONOFF	0.00084278327	5,998.00	-7.079	8.699
REF	0.00087367323	44,998.00	-7.043	10.714
ONOFF	0.00107184977	5,998.00	-6.838	8.699
ONOFF	0.00229792253	14,999.00	-6.076	9.616
ONOFF	0.04543499955	1,800.00	-3.091	7.496

N = 55

----- Equipment Type=OEL SERVICE=HL -----

Plant Type	Measured Emission Rate(kg/hr)	Screening Value (ppmv)	Natural Log of Emission Rate (kg/hr)	Natural Log of Screening Value (ppmv)
REF	0.00000137984	195.00	-13.494	5.273
ONOFF	0.00000453597	107.50	-12.303	4.677
ONOFF	0.00000498957	33.50	-12.208	3.512
ONOFF	0.00000544316	75.00	-12.121	4.317
ONOFF	0.00000544316	170.00	-12.121	5.136
ONOFF	0.00000635036	85.50	-11.967	4.449
ONOFF	0.00001224712	75.00	-11.310	4.317
ONOFF	0.00002948381	95.00	-10.432	4.554
ONOFF	0.00005533884	142.00	-9.802	4.956
ONOFF	0.00005715323	58.00	-9.770	4.060
ONOFF	0.00006304999	329.50	-9.672	5.798
ONOFF	0.00008074027	2,994.00	-9.424	8.004
REF	0.00011177991	1,097.50	-9.099	7.001
REF	0.00018571169	15,496.50	-8.591	9.648
ONOFF	0.00045904019	1,194.00	-7.686	7.085
ONOFF	0.00109226163	4,990.00	-6.820	8.515

N = 16

TABLE C-1-1. BAGGING DATA USED TO DEVELOP CORRELATION EQUATIONS
(CONTINUED)

Table C-1-1. Bagging Data Used to Develop Correlation Equations

----- Equipment Type=OEL SERVICE=LL -----

Plant Type	Measured Emission Rate(kg/hr)	Screening Value (ppmv)	Natural Log of Emission Rate (kg/hr)	Natural Log of Screening Value (ppmv)
ONOFF	0.00000045360	698.00	-14.606	6.548
REF	0.00000079071	100.00	-14.050	4.605
ONOFF	0.00000090719	293.00	-13.913	5.680
MT	0.00000109340	1.00	-13.726	0.000
ONOFF	0.00000136079	122.00	-13.507	4.804
MT	0.00000179606	2.00	-13.230	0.693
ONOFF	0.00000181439	3.75	-13.220	1.322
REF	0.00000269491	14.50	-12.824	2.674
ONOFF	0.00000272158	96.00	-12.814	4.564
ONOFF	0.00000272158	75.00	-12.814	4.317
ONOFF	0.00000272158	110.00	-12.814	4.700
REF	0.00000272462	1,448.00	-12.813	7.278
MT	0.00000289948	8.00	-12.751	2.079
MT	0.00000312574	1.75	-12.676	0.560
ONOFF	0.00000317518	63.00	-12.660	4.143
ONOFF	0.00000317518	547.00	-12.660	6.304
REF	0.00000396675	488.00	-12.438	6.190
ONOFF	0.00000453597	1,004.00	-12.303	6.912
ONOFF	0.00000725755	180.00	-11.833	5.193
ONOFF	0.00000725755	1,148.00	-11.833	7.046
ONOFF	0.00000771115	148.00	-11.773	4.997
ONOFF	0.00000771115	1,000.50	-11.773	6.908
REF	0.00000810124	247.00	-11.723	5.509
ONOFF	0.00000861834	535.00	-11.662	6.282
MT	0.00001089767	175.50	-11.427	5.168
ONOFF	0.00001224712	3.00	-11.310	1.099
MT	0.00001287898	545.50	-11.260	6.302
ONOFF	0.00001360791	996.00	-11.205	6.904
REF	0.00001366144	522.50	-11.201	6.259
ONOFF	0.00001496870	2.50	-11.110	0.916
ONOFF	0.00002131906	44.00	-10.756	3.784
ONOFF	0.00002585503	1,498.00	-10.563	7.312
ONOFF	0.00002721582	99.00	-10.512	4.595
REF	0.00003169282	1,493.00	-10.359	7.309
REF	0.00003332713	66.50	-10.309	4.197
MT	0.00003502223	296.00	-10.260	5.690
ONOFF	0.00004127733	2,144.00	-10.095	7.670
ONOFF	0.00004399891	1,492.00	-10.031	7.308
MT	0.00004551393	51.00	-9.997	3.932
ONOFF	0.00007529711	849.00	-9.494	6.744
REF	0.00007992833	3,243.00	-9.434	8.084
REF	0.00009666606	14,846.00	-9.244	9.605
ONOFF	0.00010659530	1,748.00	-9.146	7.466
ONOFF	0.00010704890	6,985.00	-9.142	8.852
ONOFF	0.00011067767	796.00	-9.109	6.680

TABLE C-1-1. BAGGING DATA USED TO DEVELOP CORRELATION EQUATIONS
(CONTINUED)

Table C-1-1. Bagging Data Used to Develop Correlation Equations

----- Equipment Type=OEL SERVICE=LL -----
(continued)

Plant Type	Measured Emission Rate(kg/hr)	Screening Value (ppmv)	Natural Log of Emission Rate (kg/hr)	Natural Log of Screening Value (ppmv)
ONOFF	0.00012428558	2,200.00	-8.993	7.696
ONOFF	0.00013063594	34,996.00	-8.943	10.463
REF	0.00013571623	535.00	-8.905	6.282
ONOFF	0.00020956183	2,097.00	-8.470	7.648
ONOFF	0.00023541686	2,248.00	-8.354	7.718
MT	0.00028113490	142.00	-8.177	4.956
ONOFF	0.00029483807	1,744.00	-8.129	7.464
REF	0.00035645469	1,996.00	-7.939	7.599
ONOFF	0.00035970244	1,190.00	-7.930	7.082
ONOFF	0.00038510387	4,489.00	-7.862	8.409
MT	0.00053411050	495.00	-7.535	6.205
REF	0.00056373038	12,493.50	-7.481	9.433
MT	0.00056382110	93.00	-7.481	4.533
MT	0.00076480994	1,186.00	-7.176	7.078
MT	0.00082414043	210.00	-7.101	5.347
MT	0.00086428377	1,039.00	-7.054	6.946
REF	0.00092007620	12,990.00	-6.991	9.472
ONOFF	0.00120112492	37,492.00	-6.724	10.532
MT	0.00175405969	990.00	-6.346	6.898
ONOFF	0.00219268802	19,992.00	-6.123	9.903
ONOFF	0.00361471469	42,493.00	-5.623	10.657
ONOFF	0.00594257462	69,994.00	-5.126	11.156
ONOFF	0.00753968974	347.00	-4.888	5.849
REF	0.00883470924	26,795.00	-4.729	10.196
MT	0.05022226254	7,992.00	-2.991	8.986

N = 70

----- Equipment Type=OTHER SERVICE=G -----

Plant Type	Measured Emission Rate(kg/hr)	Screening Value (ppmv)	Natural Log of Emission Rate (kg/hr)	Natural Log of Screening Value (ppmv)
MT	0.00001317427	970.00	-11.237	6.877

N = 1

TABLE C-1-1. BAGGING DATA USED TO DEVELOP CORRELATION EQUATIONS
(CONTINUED)

Table C-1-1. Bagging Data Used to Develop Correlation Equations

----- Equipment Type=OTHER SERVICE=LL -----

Plant Type	Measured Emission Rate(kg/hr)	Screening Value (ppmv)	Natural Log of Emission Rate (kg/hr)	Natural Log of Screening Value (ppmv)
MT	0.00000408142	73.00	-12.409	4.290
MT	0.00001337113	3,995.00	-11.222	8.293
MT	0.00003222716	2,991.00	-10.343	8.003

N = 3

----- Equipment Type=PRV SERVICE=G -----

Plant Type	Measured Emission Rate(kg/hr)	Screening Value (ppmv)	Natural Log of Emission Rate (kg/hr)	Natural Log of Screening Value (ppmv)
REF	0.00000184074	2,595.00	-13.205	7.861
ONOFF	0.00000408237	19.00	-12.409	2.944
ONOFF	0.00001451510	81.00	-11.140	4.394
ONOFF	0.00007393631	149.00	-9.512	5.004
ONOFF	0.00010387372	578.50	-9.172	6.360
ONOFF	0.00014651184	1,345.00	-8.828	7.204
ONOFF	0.00029166289	1,741.00	-8.140	7.462

N = 7

----- Equipment Type=PRV SERVICE=LL -----

Plant Type	Measured Emission Rate(kg/hr)	Screening Value (ppmv)	Natural Log of Emission Rate (kg/hr)	Natural Log of Screening Value (ppmv)
REF	0.00000105779	3.80	-13.759	1.335
ONOFF	0.00001496870	297.00	-11.110	5.694
ONOFF	0.00002812302	997.00	-10.479	6.905
ONOFF	0.00024312801	5,491.00	-8.322	8.611

N = 4

TABLE C-1-1. BAGGING DATA USED TO DEVELOP CORRELATION EQUATIONS
(CONTINUED)

Table C-1-1. Bagging Data Used to Develop Correlation Equations

----- Equipment Type=PUMP SERVICE=HL -----

Plant Type	Measured Emission Rate(kg/hr)	Screening Value (ppmv)	Natural Log of Emission Rate (kg/hr)	Natural Log of Screening Value (ppmv)
REF	0.00000090434	281.00	-13.916	5.638
REF	0.00000241563	10.00	-12.934	2.303
REF	0.00000450227	6.80	-12.311	1.917
REF	0.00001091808	19.00	-11.425	2.944
REF	0.00002612447	18.00	-10.553	2.890
REF	0.00006783543	9.50	-9.598	2.251
REF	0.00032885331	45.50	-8.020	3.818
REF	0.00082590946	323.00	-7.099	5.778
REF	0.00089771387	1,145.50	-7.016	7.044
REF	0.00290669509	277.00	-5.841	5.624
REF	0.01268710877	9,496.50	-4.367	9.159

N = 11

TABLE C-1-1. BAGGING DATA USED TO DEVELOP CORRELATION EQUATIONS
(CONTINUED)

Table C-1-1. Bagging Data Used to Develop Correlation Equations

----- Equipment Type=PUMP SERVICE=LL -----

Plant Type	Measured Emission Rate(kg/hr)	Screening Value (ppmv)	Natural Log of Emission Rate (kg/hr)	Natural Log of Screening Value (ppmv)
MT	0.0000569400	24.50	-12.076	3.199
REF	0.00002452599	107.00	-10.616	4.673
MT	0.00002501950	2.00	-10.596	0.693
MT	0.00002550576	20.00	-10.577	2.996
MT	0.00003079742	95.00	-10.388	4.554
REF	0.00003737186	7,999.00	-10.195	8.987
MT	0.00003825274	45.50	-10.171	3.818
REF	0.00004112537	126.00	-10.099	4.836
REF	0.00004198993	192.00	-10.078	5.257
REF	0.00005151955	66.50	-9.874	4.197
REF	0.00006067767	4.50	-9.710	1.504
MT	0.00006509571	5.00	-9.640	1.609
MT	0.00006677855	7.50	-9.614	2.015
REF	0.00014387644	22.00	-8.847	3.091
REF	0.00018934954	21.50	-8.572	3.068
REF	0.00028473646	7,999.00	-8.164	8.987
REF	0.00034099156	136.00	-7.984	4.913
MT	0.00034670235	8,945.50	-7.967	9.099
REF	0.00048530346	127.00	-7.631	4.844
REF	0.00052476640	15.50	-7.553	2.741
REF	0.00059974599	1,780.00	-7.419	7.484
REF	0.00062650821	66.00	-7.375	4.190
MT	0.00066574435	43.00	-7.315	3.761
REF	0.00082055702	27,996.00	-7.106	10.240
REF	0.00086514560	33,744.50	-7.053	10.427
MT	0.00092406786	6,868.00	-6.987	8.835
REF	0.00095527533	5,970.00	-6.954	8.695
REF	0.00119445704	22,995.00	-6.730	10.043
REF	0.00121223805	1,394.00	-6.715	7.240
REF	0.00122534700	621.00	-6.705	6.431
REF	0.00153538057	183.50	-6.479	5.212
REF	0.00179438447	1,697.00	-6.323	7.437
REF	0.00220076204	947.00	-6.119	6.853
REF	0.00301020593	996.00	-5.806	6.904
REF	0.00489884786	395.00	-5.319	5.979
REF	0.00679034746	5,745.50	-4.992	8.656
REF	0.00757234873	4,997.00	-4.883	8.517
REF	0.00958087635	41,995.00	-4.648	10.645
REF	0.00968248208	13,995.00	-4.637	9.546
MT	0.01317699356	4,488.00	-4.329	8.409
REF	0.03439081920	17,694.50	-3.370	9.781
ONOFF	0.07243808401	4,992.00	-2.625	8.516

N = 42

TABLE C-1-1. BAGGING DATA USED TO DEVELOP CORRELATION EQUATIONS
(CONTINUED)

Table C-1-1. Bagging Data Used to Develop Correlation Equations

----- Equipment Type=STUFFING BOX SERVICE=HL -----

Plant Type	Measured Emission Rate(kg/hr)	Screening Value (ppmv)	Natural Log of Emission Rate (kg/hr)	Natural Log of Screening Value (ppmv)
ONOFF	0.00000317518	26.00	-12.660	3.258
ONOFF	0.00000317518	46.00	-12.660	3.829
ONOFF	0.00000317518	47.50	-12.660	3.861
ONOFF	0.00000544316	75.00	-12.121	4.317
ONOFF	0.00000589676	162.00	-12.041	5.088
ONOFF	0.00001043273	145.00	-11.471	4.977
ONOFF	0.00001451510	145.00	-11.140	4.977
ONOFF	0.00004127733	127.00	-10.095	4.844
ONOFF	0.00007076114	294.00	-9.556	5.684
ONOFF	0.00089630772	795.00	-7.017	6.678
ONOFF	0.00129592670	1,095.00	-6.649	6.999

N = 11

----- Equipment Type=STUFFING BOX SERVICE=LL -----

Plant Type	Measured Emission Rate(kg/hr)	Screening Value (ppmv)	Natural Log of Emission Rate (kg/hr)	Natural Log of Screening Value (ppmv)
ONOFF	0.00014197587	293.00	-8.860	5.680
ONOFF	0.00032114669	842.00	-8.044	6.736
ONOFF	0.00046266896	630.00	-7.678	6.446
ONOFF	0.00052390456	71.00	-7.554	4.263
ONOFF	0.00059421210	647.00	-7.428	6.472
ONOFF	0.00107321056	4,498.00	-6.837	8.411
ONOFF	0.00114442529	1,246.00	-6.773	7.128
ONOFF	0.00120611449	992.00	-6.720	6.900
ONOFF	0.00142293387	748.00	-6.555	6.617
ONOFF	0.00371586682	3,994.00	-5.595	8.293
ONOFF	0.00399664338	4,498.00	-5.522	8.411
ONOFF	0.00602331489	3,496.00	-5.112	8.159

N = 12

TABLE C-1-1. BAGGING DATA USED TO DEVELOP CORRELATION EQUATIONS
(CONTINUED)

Table C-1-1. Bagging Data Used to Develop Correlation Equations

----- Equipment Type=VALVE SERVICE=G -----

Plant Type	Measured Emission Rate(kg/hr)	Screening Value (ppmv)	Natural Log of Emission Rate (kg/hr)	Natural Log of Screening Value (ppmv)
ONOFF	0.00000045360	1.25	-14.606	0.223
ONOFF	0.00000045360	9.00	-14.606	2.197
ONOFF	0.00000045360	52.50	-14.606	3.961
ONOFF	0.00000045360	1,997.00	-14.606	7.599
ONOFF	0.00000090719	122.00	-13.913	4.804
REF	0.00000108460	150.00	-13.734	5.011
ONOFF	0.00000136079	142.00	-13.507	4.956
REF	0.00000162324	78.00	-13.331	4.357
MT	0.00000211567	295.50	-13.066	5.689
MT	0.00000226853	1.00	-12.996	0.000
ONOFF	0.00000272158	46.50	-12.814	3.839
ONOFF	0.00000272158	227.50	-12.814	5.427
ONOFF	0.00000317518	31.50	-12.660	3.450
ONOFF	0.00000317518	42.00	-12.660	3.738
REF	0.00000322045	33.00	-12.646	3.497
REF	0.00000323338	23.50	-12.642	3.157
ONOFF	0.00000453597	180.00	-12.303	5.193
REF	0.00000474236	11.00	-12.259	2.398
ONOFF	0.00000498957	1,497.00	-12.208	7.311
ONOFF	0.00000498957	1,780.00	-12.208	7.484
REF	0.00000566633	68.50	-12.081	4.227
REF	0.00000584324	50.00	-12.050	3.912
ONOFF	0.00000635036	749.00	-11.967	6.619
REF	0.00000662796	22.50	-11.924	3.114
ONOFF	0.00000725755	1,620.00	-11.833	7.390
ONOFF	0.00000907194	648.00	-11.610	6.474
ONOFF	0.00000952554	299.00	-11.562	5.700
REF	0.00000959040	105.00	-11.555	4.654
ONOFF	0.00000997913	3.50	-11.515	1.253
ONOFF	0.00000997913	3.50	-11.515	1.253
REF	0.00001004944	240.00	-11.508	5.481
REF	0.00001313209	66.00	-11.240	4.190
REF	0.00001568266	306.00	-11.063	5.724
REF	0.00001582872	26.00	-11.054	3.258
REF	0.00001608773	1,194.50	-11.037	7.085
ONOFF	0.00001905108	1,300.00	-10.868	7.170
REF	0.00001952236	724.00	-10.844	6.585
ONOFF	0.00002177266	96.00	-10.735	4.564
ONOFF	0.00002404064	236.50	-10.636	5.466
REF	0.00002500272	13.00	-10.597	2.565
ONOFF	0.00002721582	115.00	-10.512	4.745
REF	0.00002723941	100.00	-10.511	4.605
REF	0.00002964075	1,495.00	-10.426	7.310
REF	0.00002977456	798.50	-10.422	6.683
ONOFF	0.00002993740	71.00	-10.416	4.263

TABLE C-1-1. BAGGING DATA USED TO DEVELOP CORRELATION EQUATIONS
(CONTINUED)

Table C-1-1. Bagging Data Used to Develop Correlation Equations

----- Equipment Type=VALVE SERVICE=G -----
(continued)

Plant Type	Measured Emission Rate (kg/hr)	Screening Value (ppmv)	Natural Log of Emission Rate (kg/hr)	Natural Log of Screening Value (ppmv)
ONOFF	0.00003039100	3,485.00	-10.401	8.156
ONOFF	0.00003129819	1,880.00	-10.372	7.539
REF	0.00003320285	297.00	-10.313	5.694
ONOFF	0.00003538057	870.00	-10.249	6.768
ONOFF	0.00004581330	1,746.00	-9.991	7.465
REF	0.00004823551	396.50	-9.939	5.983
ONOFF	0.00004853488	490.00	-9.933	6.194
REF	0.00005161027	195.50	-9.872	5.276
ONOFF	0.00005171006	1,048.00	-9.870	6.955
REF	0.00005379207	331.50	-9.830	5.804
REF	0.00005465391	22.50	-9.814	3.114
REF	0.00005555656	1,049.00	-9.798	6.956
ONOFF	0.00005760682	918.00	-9.762	6.822
REF	0.00005882700	1,045.00	-9.741	6.952
REF	0.00006236052	515.00	-9.683	6.244
ONOFF	0.00006441078	169.00	-9.650	5.130
REF	0.00006601651	496.50	-9.626	6.208
ONOFF	0.00006713236	795.00	-9.609	6.678
ONOFF	0.00007030754	498.00	-9.563	6.211
ONOFF	0.00007166833	1,497.00	-9.543	7.311
REF	0.00007594121	420.00	-9.486	6.040
ONOFF	0.00008618343	249.00	-9.359	5.517
REF	0.00008973964	922.00	-9.319	6.827
ONOFF	0.00009434818	1,748.00	-9.269	7.466
REF	0.00009616711	197.50	-9.249	5.286
REF	0.00009735099	996.00	-9.237	6.904
REF	0.00010011794	1,397.00	-9.209	7.242
ONOFF	0.00010160573	525.00	-9.194	6.263
ONOFF	0.00010523451	3,993.00	-9.159	8.292
ONOFF	0.00010886329	8,180.00	-9.125	9.009
ONOFF	0.00011158487	1,996.00	-9.101	7.599
ONOFF	0.00011294566	499.00	-9.089	6.213
ONOFF	0.00012564638	749.00	-8.982	6.619
ONOFF	0.00013154314	780.00	-8.936	6.659
ONOFF	0.00013426472	785.00	-8.916	6.666
ONOFF	0.00013426472	8,400.00	-8.916	9.036
ONOFF	0.00014605824	3,999.00	-8.832	8.294
ONOFF	0.00014651184	1,997.00	-8.828	7.599
ONOFF	0.00017327406	1,994.00	-8.661	7.598
ONOFF	0.00018053162	290.00	-8.620	5.670
REF	0.00018855575	2,343.00	-8.576	7.759
REF	0.00019906105	142.00	-8.522	4.956
REF	0.00019947836	830.00	-8.520	6.721
ONOFF	0.00021727297	243.00	-8.434	5.493

TABLE C-1-1. BAGGING DATA USED TO DEVELOP CORRELATION EQUATIONS
(CONTINUED)

Table C-1-1. Bagging Data Used to Develop Correlation Equations

----- Equipment Type=VALVE SERVICE=G -----
(continued)

Plant Type	Measured Emission Rate (kg/hr)	Screening Value (ppmv)	Natural Log of Emission Rate (kg/hr)	Natural Log of Screening Value (ppmv)
ONOFF	0.00021818017	5,725.00	-8.430	8.653
REF	0.00022242130	4,246.00	-8.411	8.354
REF	0.00022387281	297.00	-8.404	5.694
REF	0.00023074027	735.00	-8.374	6.600
ONOFF	0.00023904563	798.00	-8.339	6.682
ONOFF	0.00026898304	999.00	-8.221	6.907
ONOFF	0.00026898304	1,165.00	-8.221	7.060
REF	0.00028817473	3,898.40	-8.152	8.268
ONOFF	0.00029257008	14,995.00	-8.137	9.615
ONOFF	0.00031887871	1,998.00	-8.051	7.600
ONOFF	0.00031978590	1,339.00	-8.048	7.200
ONOFF	0.00032114669	1,339.00	-8.044	7.200
ONOFF	0.00033203302	2,999.00	-8.010	8.006
REF	0.00033339381	7,995.50	-8.006	8.987
REF	0.00033416946	996.00	-8.004	6.904
ONOFF	0.00034972331	7,492.00	-7.958	8.922
REF	0.00035323415	22,495.00	-7.948	10.021
REF	0.00038567541	16,496.00	-7.861	9.711
REF	0.00041993559	1,949.00	-7.775	7.575
ONOFF	0.00043137077	2,997.00	-7.749	8.005
ONOFF	0.00043227796	3,990.00	-7.746	8.292
ONOFF	0.00053070852	3,998.00	-7.541	8.294
REF	0.00060437268	65,699.00	-7.411	11.093
ONOFF	0.00066542683	1,045.00	-7.315	6.952
REF	0.00066864737	3,493.00	-7.310	8.159
ONOFF	0.00069445704	740.00	-7.272	6.607
ONOFF	0.00074027034	699.00	-7.208	6.550
ONOFF	0.00082191781	7,495.00	-7.104	8.922
ONOFF	0.00090220448	69,995.00	-7.011	11.156
ONOFF	0.00094484260	14,999.00	-6.964	9.616
ONOFF	0.00102558287	3,241.00	-6.882	8.084
ONOFF	0.00109815840	44,998.00	-6.814	10.714
REF	0.00111190239	79,998.80	-6.802	11.290
ONOFF	0.00111358069	1,444.00	-6.800	7.275
ONOFF	0.00115621882	4,491.00	-6.763	8.410
ONOFF	0.00124965980	6,000.00	-6.685	8.700
REF	0.00132495691	7,998.00	-6.626	8.987
ONOFF	0.00145377846	2,499.00	-6.534	7.824
ONOFF	0.00155719858	5,235.00	-6.465	8.563
ONOFF	0.00207339200	3,465.00	-6.179	8.150
ONOFF	0.00244851674	2,696.00	-6.012	7.900
ONOFF	0.00269255194	44,995.00	-5.917	10.714
ONOFF	0.00380250386	7,499.00	-5.572	8.923
REF	0.01290846412	2,993.00	-4.350	8.004

TABLE C-1-1. BAGGING DATA USED TO DEVELOP CORRELATION EQUATIONS
(CONTINUED)

Table C-1-1. Bagging Data Used to Develop Correlation Equations

----- Equipment Type=VALVE SERVICE=G -----
(continued)

Plant Type	Measured Emission Rate(kg/hr)	Screening Value (ppmv)	Natural Log of Emission Rate (kg/hr)	Natural Log of Screening Value (ppmv)
ONOFF	0.01376394811	3,498.00	-4.286	8.160
ONOFF	0.01612628141	49,998.00	-4.127	10.820
ONOFF	0.04505624603	64,998.00	-3.100	11.082

N = 136

----- Equipment Type=VALVE SERVICE=HL -----

Plant Type	Measured Emission Rate(kg/hr)	Screening Value (ppmv)	Natural Log of Emission Rate (kg/hr)	Natural Log of Screening Value (ppmv)
REF	0.00000007416	22.00	-16.417	3.091
REF	0.00000024878	31.00	-15.207	3.434
REF	0.00000384555	28.00	-12.469	3.332
REF	0.00000417178	23.50	-12.387	3.157
REF	0.00000515059	30.50	-12.176	3.418
REF	0.00000583507	18.50	-12.052	2.918
ONOFF	0.00001043273	120.00	-11.471	4.787
REF	0.00002810986	121.00	-10.479	4.796
REF	0.00003200898	505.00	-10.349	6.225
REF	0.00003625011	122.50	-10.225	4.808
REF	0.00004638030	42.00	-9.979	3.738
REF	0.00007379116	167.00	-9.514	5.118
REF	0.00012682573	92.00	-8.973	4.522
REF	0.00022685294	183.00	-8.391	5.209
REF	0.00025173728	290.00	-8.287	5.670
REF	0.00028499501	464.00	-8.163	6.140
REF	0.00031120838	540.00	-8.075	6.292
REF	0.00040606459	446.00	-7.809	6.100
REF	0.00042830899	956.50	-7.756	6.863
REF	0.00047713871	2,097.50	-7.648	7.649
REF	0.00049600835	2,993.00	-7.609	8.004
REF	0.00223700445	11,494.00	-6.103	9.350
REF	0.01003356618	1,996.00	-4.602	7.599

N = 23

TABLE C-1-1. BAGGING DATA USED TO DEVELOP CORRELATION EQUATIONS
(CONTINUED)

Table C-1-1. Bagging Data Used to Develop Correlation Equations

----- Equipment Type=VALVE SERVICE=LL -----

Plant Type	Measured Emission Rate(kg/hr)	Screening Value (ppmv)	Natural Log of Emission Rate (kg/hr)	Natural Log of Screening Value (ppmv)
ONOFF	0.00000045360	510.00	-14.606	6.234
REF	0.00000067060	46.50	-14.215	3.839
ONOFF	0.00000090719	3,210.00	-13.913	8.074
REF	0.00000097029	5.50	-13.846	1.705
REF	0.00000097655	51.00	-13.839	3.932
REF	0.00000124345	5.50	-13.598	1.705
REF	0.00000157471	31.50	-13.361	3.450
ONOFF	0.00000181439	8.75	-13.220	2.169
ONOFF	0.00000181439	26.00	-13.220	3.258
REF	0.00000189545	50.00	-13.176	3.912
REF	0.00000203465	26.00	-13.105	3.258
MT	0.00000205103	4.25	-13.097	1.447
REF	0.00000209952	15.00	-13.074	2.708
REF	0.00000232450	23.50	-12.972	3.157
MT	0.00000237776	10.00	-12.949	2.303
REF	0.00000248467	33.50	-12.905	3.512
REF	0.00000401492	136.00	-12.425	4.913
MT	0.00000447800	11.50	-12.316	2.442
REF	0.00000502041	80.00	-12.202	4.382
ONOFF	0.00000635036	274.00	-11.967	5.613
REF	0.00000640298	128.50	-11.959	4.856
ONOFF	0.00000816475	49.00	-11.716	3.892
REF	0.00000834528	51.00	-11.694	3.932
ONOFF	0.00000861834	89.00	-11.662	4.489
MT	0.00000862560	524.00	-11.661	6.261
REF	0.00000895128	119.50	-11.624	4.783
MT	0.00000984079	18.00	-11.529	2.890
ONOFF	0.00000997913	142.00	-11.515	4.956
REF	0.00001072938	60.00	-11.443	4.094
REF	0.00001154767	17.00	-11.369	2.833
REF	0.00001223850	3.50	-11.311	1.253
MT	0.00001432233	59.50	-11.154	4.086
ONOFF	0.00001496870	15.50	-11.110	2.741
MT	0.00001524449	22.00	-11.091	3.091
MT	0.00001602150	34.00	-11.042	3.526
MT	0.00001613626	28.50	-11.034	3.350
REF	0.00001662116	173.00	-11.005	5.153
ONOFF	0.00001769028	339.00	-10.942	5.826
REF	0.00001839744	47.50	-10.903	3.861
ONOFF	0.00002086546	1,197.00	-10.777	7.088
ONOFF	0.00002131906	148.00	-10.756	4.997
ONOFF	0.00002267985	298.00	-10.694	5.697
MT	0.00002288442	74.00	-10.685	4.304
ONOFF	0.00002358705	59.00	-10.655	4.078
ONOFF	0.00002404064	210.00	-10.636	5.347

TABLE C-1-1. BAGGING DATA USED TO DEVELOP CORRELATION EQUATIONS
(CONTINUED)

Table C-1-1. Bagging Data Used to Develop Correlation Equations

----- Equipment Type=VALVE SERVICE=LL -----
(continued)

Plant Type	Measured Emission Rate (kg/hr)	Screening Value (ppmv)	Natural Log of Emission Rate (kg/hr)	Natural Log of Screening Value (ppmv)
MT	0.00002413726	588.00	-10.632	6.377
ONOFF	0.00002449424	1,398.00	-10.617	7.243
MT	0.00002719722	75.00	-10.512	4.317
ONOFF	0.00002721582	8,960.00	-10.512	9.101
REF	0.00002937177	646.00	-10.435	6.471
ONOFF	0.00003175179	2,497.00	-10.358	7.823
REF	0.00003262633	176.00	-10.330	5.170
MT	0.00003474508	45.00	-10.267	3.807
ONOFF	0.00003492697	1,143.00	-10.262	7.041
MT	0.00003817473	119.00	-10.173	4.779
MT	0.00003920348	181.00	-10.147	5.198
REF	0.00004325547	400.50	-10.048	5.993
ONOFF	0.00004399891	441.00	-10.031	6.089
MT	0.00004902930	116.00	-9.923	4.754
MT	0.00005014515	109.00	-9.901	4.691
REF	0.00005050349	447.50	-9.893	6.104
MT	0.00005156491	22.00	-9.873	3.091
ONOFF	0.00005352445	1,998.00	-9.835	7.600
MT	0.00005386918	205.00	-9.829	5.323
MT	0.00005803320	691.00	-9.754	6.538
MT	0.00005873628	124.00	-9.742	4.820
REF	0.00005976594	108.80	-9.725	4.690
REF	0.00005993377	793.00	-9.722	6.676
REF	0.00006152590	100.00	-9.696	4.605
MT	0.00006221537	116.00	-9.685	4.754
REF	0.00006287762	2,496.00	-9.674	7.822
MT	0.00006335843	61.00	-9.667	4.111
MT	0.00006978137	71.50	-9.570	4.270
ONOFF	0.00007575070	3,249.00	-9.488	8.086
ONOFF	0.00007756509	272.00	-9.464	5.606
REF	0.00007775560	2,645.50	-9.462	7.881
REF	0.00008625601	26.50	-9.358	3.277
REF	0.00008785721	192.00	-9.340	5.257
ONOFF	0.00009026581	193.00	-9.313	5.263
ONOFF	0.00009661617	2,246.00	-9.245	7.717
REF	0.00009754604	74.00	-9.235	4.304
ONOFF	0.00010342012	17,499.00	-9.177	9.770
REF	0.00010648644	1,196.00	-9.147	7.087
REF	0.00011324050	595.00	-9.086	6.389
MT	0.00012015785	496.50	-9.027	6.208
REF	0.00012067949	5,000.00	-9.022	8.517
REF	0.00012075660	224.00	-9.022	5.412
REF	0.00013744443	23,996.00	-8.892	10.086
ONOFF	0.00014106867	2,998.00	-8.866	8.006

TABLE C-1-1. BAGGING DATA USED TO DEVELOP CORRELATION EQUATIONS
(CONTINUED)

Table C-1-1. Bagging Data Used to Develop Correlation Equations

----- Equipment Type=VALVE SERVICE=LL -----
(continued)

Plant Type	Measured Emission Rate (kg/hr)	Screening Value (ppmv)	Natural Log of Emission Rate (kg/hr)	Natural Log of Screening Value (ppmv)
MT	0.00014320058	132.00	-8.851	4.883
REF	0.00015138801	796.50	-8.796	6.680
REF	0.00015260365	2,096.50	-8.788	7.648
REF	0.00015486256	1,044.00	-8.773	6.951
ONOFF	0.00016102694	3,950.00	-8.734	8.281
ONOFF	0.00016374853	798.00	-8.717	6.682
REF	0.00016769028	894.00	-8.693	6.796
ONOFF	0.00016783090	1,997.00	-8.693	7.599
ONOFF	0.00018461399	1,995.00	-8.597	7.598
ONOFF	0.00018461399	2,244.00	-8.597	7.716
ONOFF	0.00019867550	2,998.00	-8.524	8.006
ONOFF	0.00020185068	1,344.00	-8.508	7.203
ONOFF	0.00021545859	596.00	-8.443	6.390
REF	0.00021628867	1,348.00	-8.439	7.206
REF	0.00022579153	3,493.00	-8.396	8.159
REF	0.00022907557	568.00	-8.381	6.342
MT	0.00023388370	20,897.00	-8.361	9.947
MT	0.00024798603	2,744.00	-8.302	7.917
REF	0.00025930781	12,145.50	-8.257	9.405
REF	0.00026239681	2,736.00	-8.246	7.914
ONOFF	0.00027306541	8,450.00	-8.206	9.042
MT	0.00027484804	4,996.50	-8.199	8.516
REF	0.00028502676	1,345.00	-8.163	7.204
REF	0.00028960809	1,248.00	-8.147	7.129
REF	0.00029077384	372.50	-8.143	5.920
MT	0.00029242947	187.50	-8.137	5.234
REF	0.00029891137	105.00	-8.115	4.654
REF	0.00029939672	794.00	-8.114	6.677
MT	0.00031903747	52.50	-8.050	3.961
REF	0.00032606822	4,997.50	-8.028	8.517
ONOFF	0.00032704345	498.00	-8.025	6.211
ONOFF	0.00033611540	253.50	-7.998	5.535
REF	0.00035377846	34,996.50	-7.947	10.463
REF	0.00035974780	2,240.00	-7.930	7.714
ONOFF	0.00036106323	198.00	-7.926	5.288
MT	0.00036868820	4,545.00	-7.906	8.422
ONOFF	0.00037240316	975.00	-7.896	6.882
MT	0.00041536787	3,243.00	-7.786	8.084
MT	0.00042058423	4,246.50	-7.774	8.354
MT	0.00043848771	21,994.00	-7.732	9.999
REF	0.00044372675	42,745.50	-7.720	10.663
REF	0.00045395990	893.00	-7.698	6.795
REF	0.00046035562	20,246.50	-7.684	9.916
REF	0.00046933684	796.00	-7.664	6.680

TABLE C-1-1. BAGGING DATA USED TO DEVELOP CORRELATION EQUATIONS
(CONTINUED)

Table C-1-1. Bagging Data Used to Develop Correlation Equations

----- Equipment Type=VALVE SERVICE=LL -----
(continued)

Plant Type	Measured Emission Rate (kg/hr)	Screening Value (ppmv)	Natural Log of Emission Rate (kg/hr)	Natural Log of Screening Value (ppmv)
REF	0.00047251202	8,490.00	-7.657	9.047
REF	0.00047945205	3,996.00	-7.643	8.293
REF	0.00049981856	159.50	-7.601	5.072
ONOFF	0.00052617255	19,998.00	-7.550	9.903
REF	0.00057253016	674.00	-7.465	6.513
REF	0.00060782001	23,994.50	-7.406	10.086
REF	0.00061521364	1,598.00	-7.394	7.377
MT	0.00062442166	2,147.50	-7.379	7.672
REF	0.00063122562	2,992.00	-7.368	8.004
REF	0.00066533612	133.50	-7.315	4.894
REF	0.00068511295	995.00	-7.286	6.903
ONOFF	0.00070443618	19,994.00	-7.258	9.903
MT	0.00071074118	8,091.00	-7.249	8.999
ONOFF	0.00075932142	54,997.00	-7.183	10.915
REF	0.00095572893	39,996.50	-6.953	10.597
REF	0.00098348907	1,695.00	-6.924	7.435
ONOFF	0.00102558287	54,995.00	-6.882	10.915
MT	0.00103914542	2,745.00	-6.869	7.918
REF	0.00107547854	474.00	-6.835	6.161
REF	0.00113353896	10,997.00	-6.782	9.305
ONOFF	0.00114669328	2,982.00	-6.771	8.000
ONOFF	0.00118570262	2,998.00	-6.737	8.006
MT	0.00134518734	2,257.50	-6.611	7.722
REF	0.00134786356	79,997.00	-6.609	11.290
ONOFF	0.00135444071	1,046.00	-6.604	6.953
REF	0.00135698086	7,497.00	-6.602	8.922
REF	0.00153742175	21,495.00	-6.478	9.976
MT	0.00160918080	5,434.00	-6.432	8.600
ONOFF	0.00169010251	2,740.00	-6.383	7.916
REF	0.00183253198	6,690.00	-6.302	8.808
MT	0.00188274517	8,994.00	-6.275	9.104
MT	0.00197233058	5,494.00	-6.229	8.611
REF	0.00213984396	15,998.50	-6.147	9.680
ONOFF	0.00223351175	54,998.00	-6.104	10.915
MT	0.00239059240	3,844.00	-6.036	8.254
ONOFF	0.00247028939	42,492.00	-6.003	10.657
ONOFF	0.00256236959	2,496.00	-5.967	7.822
REF	0.00258328041	1,004.00	-5.959	6.912
MT	0.00279048353	3,389.00	-5.882	8.128
MT	0.00305193686	3,302.00	-5.792	8.102
REF	0.00312115577	1,243.00	-5.770	7.125
REF	0.00471287308	2,498.00	-5.357	7.823
REF	0.00601378935	25,895.50	-5.114	10.162
REF	0.01730744806	25,490.00	-4.057	10.146

TABLE C-1-1. BAGGING DATA USED TO DEVELOP CORRELATION EQUATIONS
(CONTINUED)

Table C-1-1. Bagging Data Used to Develop Correlation Equations

----- Equipment Type=VALVE SERVICE=LL -----
(continued)

Plant Type	Measured Emission Rate(kg/hr)	Screening Value (ppmv)	Natural Log of Emission Rate (kg/hr)	Natural Log of Screening Value (ppmv)
REF	0.02037603193	72,924.00	-3.893	11.197

N = 178

----- Equipment Type=VENT SERVICE=G -----

Plant Type	Measured Emission Rate(kg/hr)	Screening Value (ppmv)	Natural Log of Emission Rate (kg/hr)	Natural Log of Screening Value (ppmv)
ONOFF	0.00000952554	99.00	-11.562	4.595
ONOFF	0.00005261725	1,998.00	-9.852	7.600
ONOFF	0.00033883698	894.00	-7.990	6.796

N = 3

----- Equipment Type=VENT SERVICE=LL -----

Plant Type	Measured Emission Rate(kg/hr)	Screening Value (ppmv)	Natural Log of Emission Rate (kg/hr)	Natural Log of Screening Value (ppmv)
ONOFF	0.00010478091	1,496.00	-9.164	7.311
ONOFF	0.00014877982	396.00	-8.813	5.981
ONOFF	0.00093168829	3,497.00	-6.979	8.160

N = 3

Table C-1-2. REGRESSION STATISTICS FOR THE 1993 REFINERY, MARKETING TERMINAL, AND OIL AND GAS PRODUCTION OPERATIONS DATA

Equipment		Facility Type ^a	Sample Size	Intercept (b ₀)	Slope (b ₁)	Root Mean Square Error (RMSE)	Coefficient of Simple Determination (R ²)	Scale Bias Correction Factor (SBCF)	Mean In Screening Value	Sum of Squared Deviations from the Mean In Screening Value
Type	Service									
Connector	Light Liquid	REF93	18	-18.01355	1.005	1.960	0.7353	5.2595	7.12669	169.2060
		MT93	21	-12.57236	0.560	1.144	0.3456	1.8293	5.28173	41.9152
		OAG93	42	-15.95523	0.860	1.564	0.5223	3.1956	6.40961	144.7306
Flange	Light Liquid	REF93	15	-14.91663	0.891	1.316	0.7503	2.1504	6.79160	85.2498
		MT93	12	-10.41103	0.237	1.748	0.0413	3.5250	5.00211	23.3301
		OAG93	13	-12.88458	0.430	1.715	0.1721	3.4347	5.73992	36.3270
Open-Ended Line	Light Liquid	REF93	15	-16.36068	0.907	1.693	0.5966	3.4293	6.97954	66.9792
		MT93	16	-14.01355	0.995	1.614	0.7372	3.1160	4.71076	103.1866
		OAG93	39	-14.59519	0.668	1.929	0.4218	5.6760	6.50333	225.1838
Pump	Light Liquid	REF93	30	-10.07607	0.419	1.579	0.3281	3.1882	6.71261	194.3916
		MT93	11	-11.40718	0.527	1.617	0.5128	2.2985	4.45340	89.1903
Valve	Gas	REF93	50	-13.94624	0.675	1.245	0.5725	2.1124	6.22836	218.6160
		OAG93	84	-15.20999	0.858	1.708	0.5296	4.1228	6.92689	365.7776
Valve	Light Liquid	REF93	82	-14.17854	0.783	1.453	0.6340	2.7995	6.56265	476.8908
		MT93	45	-13.29112	0.705	1.071	0.7036	1.7392	5.89259	235.3645
		OAG93	51	-13.79570	0.633	1.635	0.3949	3.5907	7.02241	213.3342

^aFacility types are: REF93=1993 refinery data, MT93=1993 marketing terminal data, and OAG93=1993 oil and gas production operations data

Table C-1-3. 1980 Refinery Data

----- Equipment Type=CONNECTOR SERVICE=ALL -----

Measured Emission Rate(kg/hr)	Original TLV Screening Value (ppmv)	OVA Adjusted Screening Value (ppmv)	Natural Log of Emission Rate (kg/hr)	Natural Log of TLV Screening Value (ppmv)	Natural Log of OVA Screening Value (ppmv)
0.00002862	68.49	135.17	-10.461	4.227	4.907
0.00007993	287.96	611.03	-9.434	5.663	6.415
0.00011026	43.00	82.89	-9.113	3.761	4.418
0.00011643	336.64	719.98	-9.058	5.819	6.579
0.00015369	576.42	1,266.67	-8.781	6.357	7.144
0.00021599	199.00	414.48	-8.440	5.293	6.027
0.00021940	21.47	39.96	-8.425	3.066	3.688
0.00022339	289.36	614.14	-8.407	5.668	6.420
0.00029047	1,447.68	3,332.47	-8.144	7.278	8.111
0.00031247	914.91	2,057.90	-8.071	6.819	7.629
0.00044767	425.98	921.92	-7.711	6.054	6.826
0.00045162	451.40	979.81	-7.703	6.112	6.887
0.00045829	914.48	2,056.87	-7.688	6.818	7.629
0.00058280	214.08	447.53	-7.448	5.366	6.104
0.00061930	398.97	860.61	-7.387	5.989	6.758
0.00062396	912.27	2,051.66	-7.379	6.816	7.626
0.00062744	677.13	1,500.12	-7.374	6.518	7.313
0.00084939	106.60	215.14	-7.071	4.669	5.371
0.00085546	582.26	1,280.16	-7.064	6.367	7.155
0.00087692	1,959.67	4,580.42	-7.039	7.581	8.430
0.00089035	921.20	2,072.75	-7.024	6.826	7.637
0.00117035	4,529.79	11,044.58	-6.750	8.418	9.310
0.00170106	198.70	413.81	-6.377	5.292	6.025
0.00173544	726.19	1,614.50	-6.356	6.588	7.387
0.00177404	3,302.89	7,925.90	-6.334	8.103	8.978
0.00179269	2,290.01	5,394.75	-6.324	7.736	8.593
0.00179403	999.45	2,258.09	-6.323	6.907	7.722
0.00231632	4,214.88	10,239.49	-6.068	8.346	9.234
0.00242557	2,860.43	6,814.53	-6.022	7.959	8.827
0.00342813	3,385.21	8,133.54	-5.676	8.127	9.004
0.00342813	3,385.21	8,133.54	-5.676	8.127	9.004
0.00467383	3,933.75	9,523.33	-5.366	8.277	9.161
0.00468673	3,933.74	9,523.31	-5.363	8.277	9.161
0.00468673	3,933.74	9,523.31	-5.363	8.277	9.161
0.00670911	496.56	1,083.02	-5.004	6.208	6.988
0.00956087	1,981.92	4,635.07	-4.650	7.592	8.441
0.00988148	4,890.96	11,971.40	-4.617	8.495	9.390
0.01433650	4,984.13	12,211.05	-4.245	8.514	9.410

N = 38

Table C-1-3. 1980 Refinery Data (Con't.)

----- Equipment Type=DRAIN SERVICE=ALL -----

Measured Emission Rate(kg/hr)	Original TLV Screening Value (ppmv)	OVA Adjusted Screening Value (ppmv)	Natural Log of Emission Rate (kg/hr)	Natural Log of TLV Screening Value (ppmv)	Natural Log of OVA Screening Value (ppmv)
0.00000165	124.56	253.38	-13.318	4.825	5.535
0.00001587	124.20	252.60	-11.051	4.822	5.532
0.00002657	125.41	255.18	-10.536	4.832	5.542
0.00006707	306.36	652.11	-9.610	5.725	6.480
0.00016828	1,084.56	2,460.50	-8.690	6.989	7.808
0.00025242	110.79	224.04	-8.284	4.708	5.412
0.00066593	4.88	8.44	-7.314	1.586	2.133
0.00067665	247.44	521.05	-7.298	5.511	6.256
0.00109637	255.86	539.70	-6.816	5.545	6.291
0.00111300	1,093.11	2,480.86	-6.801	6.997	7.816
0.00163974	9,675.85	24,512.03	-6.413	9.177	10.107
0.00164782	84.27	168.08	-6.408	4.434	5.124
0.00168344	249.76	526.17	-6.387	5.520	6.266
0.00168969	249.75	526.16	-6.383	5.520	6.266
0.00169157	1,095.50	2,486.57	-6.382	6.999	7.819
0.00169595	249.75	526.16	-6.380	5.520	6.266
0.00170673	337.53	721.97	-6.373	5.822	6.582
0.00263438	344.99	738.73	-5.939	5.844	6.605
0.00271318	126.27	257.03	-5.910	4.838	5.549
0.00282061	85.42	170.48	-5.871	4.448	5.139
0.00286144	205.12	427.86	-5.856	5.324	6.059
0.00414221	3,256.12	7,808.06	-5.487	8.088	8.963
0.00414368	1,082.80	2,456.31	-5.486	6.987	7.806
0.00420110	345.22	739.25	-5.472	5.844	6.606
0.00428421	255.41	538.69	-5.453	5.543	6.289
0.00433189	204.22	425.90	-5.442	5.319	6.054
0.00690873	1,213.08	2,767.64	-4.975	7.101	7.926
0.00691392	209.53	437.53	-4.974	5.345	6.081
0.00696835	413.59	893.79	-4.966	6.025	6.795
0.00716594	252.19	531.56	-4.938	5.530	6.276
0.00716625	252.52	532.30	-4.938	5.531	6.277
0.00719254	252.19	531.55	-4.935	5.530	6.276
0.00722439	2,659.82	6,313.44	-4.930	7.886	8.750
0.01088314	672.51	1,489.38	-4.521	6.511	7.306
0.01097489	254.74	537.20	-4.512	5.540	6.286
0.01097489	254.74	537.20	-4.512	5.540	6.286
0.01117409	610.07	1,344.46	-4.494	6.414	7.204
0.01119616	414.95	896.86	-4.492	6.028	6.799
0.01147153	2,922.21	6,969.21	-4.468	7.980	8.849
0.01147253	2,929.91	6,988.51	-4.468	7.983	8.852
0.01673968	254.28	536.20	-4.090	5.538	6.285
0.01673968	254.28	536.20	-4.090	5.538	6.285
0.01748345	600.96	1,323.40	-4.047	6.399	7.188
0.01761340	600.95	1,323.36	-4.039	6.399	7.188
0.01778718	414.14	895.03	-4.029	6.026	6.797

Table C-1-3. 1980 Refinery Data (Con't.)

----- Equipment Type=DRAIN SERVICE=ALL -----

Measured Emission Rate(kg/hr)	Original TLV Screening Value (ppmv)	OVA Adjusted Screening Value (ppmv)	Natural Log of Emission Rate (kg/hr)	Natural Log of TLV Screening Value (ppmv)	Natural Log of OVA Screening Value (ppmv)
0.01794441	9,705.86	24,591.90	-4.020	9.180	10.110
0.02777731	9,675.31	24,510.60	-3.584	9.177	10.107
0.02864463	2,945.66	7,027.99	-3.553	7.988	8.858
0.04440422	2,195.64	5,161.48	-3.114	7.694	8.549
0.04565131	1,658.94	3,845.08	-3.087	7.414	8.255
0.11170747	2,216.10	5,212.02	-2.192	7.704	8.559
0.11520974	9,757.82	24,730.22	-2.161	9.186	10.116
0.28962977	9,643.68	24,426.45	-1.239	9.174	10.103
0.28962977	9,643.68	24,426.45	-1.239	9.174	10.103
0.28965511	9,669.08	24,494.01	-1.239	9.177	10.106
0.43111208	2,966.41	7,079.99	-0.841	7.995	8.865
0.43111208	2,966.41	7,079.99	-0.841	7.995	8.865
1.12802623	9,741.28	24,686.17	0.120	9.184	10.114
1.14068097	9,753.65	24,719.09	0.132	9.185	10.115
1.77893548	9,735.45	24,670.65	0.576	9.184	10.113
1.78553430	9,735.29	24,670.24	0.580	9.184	10.113

N = 61

Table C-1-3. 1980 Refinery Data (Con't.)

----- Equipment Type=PUMP SERVICE=HL -----

Measured Emission Rate(kg/hr)	Original TLV Screening Value (ppmv)	OVA Adjusted Screening Value (ppmv)	Natural Log of Emission Rate (kg/hr)	Natural Log of TLV Screening Value (ppmv)	Natural Log of OVA Screening Value (ppmv)
0.00002962	8.11	14.37	-10.427	2.093	2.665
0.00003944	90.04	180.18	-10.141	4.500	5.194
0.00015933	330.36	705.88	-8.745	5.800	6.559
0.00030611	115.55	234.17	-8.092	4.750	5.456
0.00043153	181.88	377.09	-7.748	5.203	5.932
0.00043691	711.47	1,580.13	-7.736	6.567	7.365
0.00044418	712.29	1,582.04	-7.719	6.568	7.366
0.00044597	198.46	413.29	-7.715	5.291	6.024
0.00089174	257.29	542.85	-7.022	5.550	6.297
0.00121225	713.23	1,584.25	-6.715	6.570	7.368
0.00121225	713.23	1,584.25	-6.715	6.570	7.368
0.00121559	714.87	1,588.07	-6.713	6.572	7.370
0.00121579	607.33	1,338.12	-6.712	6.409	7.199
0.00125953	913.98	2,055.71	-6.677	6.818	7.628
0.00168810	3,960.24	9,590.69	-6.384	8.284	9.169
0.00178173	710.83	1,578.63	-6.330	6.566	7.364
0.00180113	846.36	1,896.25	-6.319	6.741	7.548
0.00183552	1,188.93	2,709.80	-6.300	7.081	7.905
0.00242435	789.16	1,761.85	-6.022	6.671	7.474
0.00244487	661.26	1,463.22	-6.014	6.494	7.288
0.00245776	844.47	1,891.79	-6.009	6.739	7.545
0.00250471	1,176.77	2,680.70	-5.990	7.071	7.894
0.00251852	1,179.48	2,687.17	-5.984	7.073	7.896
0.00345651	916.25	2,061.05	-5.667	6.820	7.631
0.00479664	10,438.79	26,546.18	-5.340	9.253	10.187
0.00481697	2,376.33	5,608.57	-5.336	7.773	8.632
0.00483651	648.56	1,433.70	-5.332	6.475	7.268
0.00697471	504.98	1,102.31	-4.965	6.225	7.005
0.00962437	425.60	921.06	-4.643	6.053	6.826
0.00978532	392.28	845.47	-4.627	5.972	6.740
0.00986119	10,464.10	26,613.82	-4.619	9.256	10.189
0.00986121	10,440.11	26,549.72	-4.619	9.253	10.187
0.00995942	1,982.33	4,636.09	-4.609	7.592	8.442
0.00996275	1,422.56	3,271.75	-4.609	7.260	8.093
0.01438591	4,733.39	11,566.60	-4.242	8.462	9.356
0.01931711	3,127.43	7,484.21	-3.947	8.048	8.921
0.01950717	10,513.52	26,745.84	-3.937	9.260	10.194
0.01966882	10,513.54	26,745.91	-3.929	9.260	10.194
0.01970286	1,861.25	4,339.10	-3.927	7.529	8.375
0.02633481	506.84	1,106.58	-3.637	6.228	7.009
0.02731456	3,677.22	8,872.08	-3.600	8.210	9.091
0.02754090	3,681.46	8,882.81	-3.592	8.211	9.092
0.02775928	5,249.27	12,894.31	-3.584	8.566	9.465
0.02815822	199.52	415.60	-3.570	5.296	6.030
0.02818559	1,184.04	2,698.10	-3.569	7.077	7.900

Table C-1-3. 1980 Refinery Data (Con't.)

Measured Emission Rate(kg/hr)	Original TLV Screening Value (ppmv)	OVA Adjusted Screening Value (ppmv)	Natural Log of Emission Rate (kg/hr)	Natural Log of TLV Screening Value (ppmv)	Natural Log of OVA Screening Value (ppmv)
0.02842387	1,003.61	2,267.96	-3.561	6.911	7.727
0.02850212	1,003.61	2,267.96	-3.558	6.911	7.727
0.02850212	1,004.76	2,270.70	-3.558	6.913	7.728
0.02859211	10,538.38	26,812.30	-3.555	9.263	10.197
0.02859211	10,538.38	26,812.30	-3.555	9.263	10.197
0.03691188	1,018.75	2,303.91	-3.299	6.926	7.742
0.03917114	3,092.10	7,395.43	-3.240	8.037	8.909
0.03955608	10,526.89	26,781.58	-3.230	9.262	10.195
0.05258516	2,621.03	6,216.74	-2.945	7.871	8.735
0.05616945	2,837.15	6,756.30	-2.879	7.951	8.818
0.07550022	10,588.68	26,946.74	-2.584	9.268	10.202
0.11098012	9,451.61	23,915.68	-2.198	9.154	10.082
0.11374890	10,589.44	26,948.76	-2.174	9.268	10.202
0.15479117	10,565.72	26,885.35	-1.866	9.265	10.199
0.30036837	10,506.45	26,726.96	-1.203	9.260	10.193
0.30369119	10,518.53	26,759.24	-1.192	9.261	10.195

N = 61

Table C-1-3. 1980 Refinery Data (Con't.)

----- Equipment Type=P_CS_PRV SERVICE=LL_G_TPS -----					
Measured Emission Rate(kg/hr)	Original TLV Screening Value (ppmv)	OVA Adjusted Screening Value (ppmv)	Natural Log of Emission Rate (kg/hr)	Natural Log of TLV Screening Value (ppmv)	Natural Log of OVA Screening Value (ppmv)
0.00004237	3,392.48	8,151.87	-10.069	8.129	9.006
0.00006298	136.58	279.12	-9.673	4.917	5.632
0.00006364	1,886.21	4,400.25	-9.662	7.542	8.389
0.00006397	1,534.24	3,542.06	-9.657	7.336	8.172
0.00010622	170.88	353.17	-9.150	5.141	5.867
0.00016673	3,408.70	8,192.83	-8.699	8.134	9.011
0.00017201	594.94	1,309.46	-8.668	6.388	7.177
0.00041408	374.65	805.59	-7.789	5.926	6.692
0.00041408	374.65	805.59	-7.789	5.926	6.692
0.00042163	1,089.97	2,473.39	-7.771	6.994	7.813
0.00043552	35.08	66.94	-7.739	3.558	4.204
0.00068080	268.97	568.78	-7.292	5.595	6.343
0.00068243	193.58	402.61	-7.290	5.266	5.998
0.00104082	3,463.88	8,332.20	-6.868	8.150	9.028
0.00105002	1,716.27	3,984.79	-6.859	7.448	8.290
0.00105273	1,205.32	2,749.04	-6.856	7.094	7.919
0.00105947	3,814.46	9,220.20	-6.850	8.247	9.129
0.00106711	24.55	46.02	-6.843	3.201	3.829
0.00107106	24.55	46.02	-6.839	3.201	3.829
0.00108841	431.13	933.64	-6.823	6.066	6.839
0.00108885	245.52	516.81	-6.823	5.503	6.248
0.00167903	970.51	2,189.47	-6.390	6.878	7.691
0.00170760	1,207.89	2,755.21	-6.373	7.097	7.921
0.00173961	431.38	934.21	-6.354	6.067	6.840
0.00254547	685.07	1,518.60	-5.973	6.530	7.326
0.00259400	4,915.33	12,034.08	-5.955	8.500	9.395
0.00259443	1,742.04	4,047.66	-5.954	7.463	8.306
0.00263011	15,437.18	40,039.38	-5.941	9.645	10.598
0.00264161	3,073.11	7,347.73	-5.936	8.030	8.902
0.00268912	1,216.00	2,774.64	-5.919	7.103	7.928
0.00271908	1,216.01	2,774.68	-5.907	7.103	7.928
0.00272186	383.07	824.63	-5.906	5.948	6.715
0.00399588	13,479.04	34,722.28	-5.522	9.509	10.455
0.00405129	1,224.09	2,794.03	-5.509	7.110	7.935
0.00406909	3,070.07	7,340.09	-5.504	8.029	8.901
0.00416407	34,171.65	92,254.02	-5.481	10.439	11.432
0.00423609	1,952.06	4,561.75	-5.464	7.577	8.425
0.00423609	1,952.06	4,561.75	-5.464	7.577	8.425
0.00641761	549.40	1,204.39	-5.049	6.309	7.094
0.00646354	11,933.39	30,552.46	-5.042	9.387	10.327
0.00655481	1,738.73	4,039.58	-5.028	7.461	8.304
0.00656223	2,472.04	5,846.08	-5.026	7.813	8.674
0.00656741	6,115.18	15,137.41	-5.026	8.719	9.625
0.00658649	6,816.89	16,967.08	-5.023	8.827	9.739
0.00665525	34,348.91	92,756.76	-5.012	10.444	11.438

Table C-1-3. 1980 Refinery Data (Con't.)

----- Equipment Type=P_CS_PRV SERVICE=LL_G_TPS -----
 (continued)

Measured Emission Rate(kg/hr)	Original TLV Screening Value (ppmv)	OVA Adjusted Screening Value (ppmv)	Natural Log of Emission Rate (kg/hr)	Natural Log of TLV Screening Value (ppmv)	Natural Log of OVA Screening Value (ppmv)
0.00672364	3,057.93	7,309.60	-5.002	8.025	8.897
0.00673458	18,598.42	48,693.93	-5.001	9.831	10.793
0.00679853	3,057.97	7,309.71	-4.991	8.026	8.897
0.00684900	3,053.32	7,298.03	-4.984	8.024	8.895
0.00690833	1,550.34	3,581.13	-4.975	7.346	8.183
0.01031255	158.23	325.77	-4.574	5.064	5.786
0.01036867	11,977.05	30,669.89	-4.569	9.391	10.331
0.01058991	3,017.82	7,208.93	-4.548	8.012	8.883
0.01085059	17,055.40	44,459.47	-4.524	9.744	10.702
0.01088011	1,544.12	3,566.03	-4.521	7.342	8.179
0.01088011	1,544.12	3,566.03	-4.521	7.342	8.179
0.01580135	18,934.25	49,617.93	-4.148	9.849	10.812
0.01593600	776.04	1,731.11	-4.139	6.654	7.457
0.01650647	34,388.01	92,867.66	-4.104	10.445	11.439
0.01656751	34,388.09	92,867.88	-4.100	10.445	11.439
0.01689730	3,810.16	9,209.28	-4.081	8.245	9.128
0.01692011	24,077.03	63,863.87	-4.079	10.089	11.065
0.01719892	1,535.57	3,545.31	-4.063	7.337	8.173
0.01719892	1,535.57	3,545.31	-4.063	7.337	8.173
0.02585373	3,477.82	8,367.42	-3.655	8.154	9.032
0.02593482	17,205.09	44,869.44	-3.652	9.753	10.712
0.02608028	60,696.69	168,680.19	-3.647	11.014	12.036
0.02608058	60,603.82	168,409.10	-3.647	11.012	12.034
0.02627388	60,604.52	168,411.13	-3.639	11.012	12.034
0.02639205	1,560.08	3,604.77	-3.635	7.352	8.190
0.02646313	4,937.17	12,090.24	-3.632	8.505	9.400
0.02686162	1,747.13	4,060.09	-3.617	7.466	8.309
0.02686725	21,446.53	56,555.63	-3.617	9.973	10.943
0.02690520	305.39	649.94	-3.615	5.722	6.477
0.02699393	2,453.79	5,800.75	-3.612	7.805	8.666
0.02749516	6,829.08	16,998.96	-3.594	8.829	9.741
0.02757885	34,200.07	92,334.61	-3.591	10.440	11.433
0.02757885	34,200.07	92,334.61	-3.591	10.440	11.433
0.02768154	34,095.81	92,038.95	-3.587	10.437	11.430
0.02778396	34,095.89	92,039.17	-3.583	10.437	11.430
0.02780143	6,829.17	16,999.20	-3.583	8.829	9.741
0.02813742	6,005.66	14,852.78	-3.571	8.700	9.606
0.02824146	6,005.69	14,852.85	-3.567	8.700	9.606
0.03877057	30,226.79	81,100.81	-3.250	10.316	11.303
0.03927627	8,464.05	21,297.97	-3.237	9.044	9.966
0.03996025	6,008.29	14,859.61	-3.220	8.701	9.606
0.03999937	690.59	1,531.47	-3.219	6.538	7.334
0.04005716	54,394.88	150,333.83	-3.217	10.904	11.921
0.04060862	38,084.57	103,381.36	-3.204	10.548	11.546

Table C-1-3. 1980 Refinery Data (Con't.)

----- Equipment Type=P_CS_PRV SERVICE=LL_G_TPS -----
 (continued)

Measured Emission Rate(kg/hr)	Original TLV Screening Value (ppmv)	OVA Adjusted Screening Value (ppmv)	Natural Log of Emission Rate (kg/hr)	Natural Log of TLV Screening Value (ppmv)	Natural Log of OVA Screening Value (ppmv)
0.04060908	38,026.29	103,215.21	-3.204	10.546	11.545
0.04187031	11,943.02	30,578.34	-3.173	9.388	10.328
0.04256917	9,349.99	23,645.64	-3.157	9.143	10.071
0.04256917	9,349.99	23,645.64	-3.157	9.143	10.071
0.04283001	2,432.76	5,748.56	-3.151	7.797	8.657
0.04283051	2,429.05	5,739.33	-3.151	7.795	8.655
0.06487572	24,414.57	64,804.64	-2.735	10.103	11.079
0.06532933	42,937.13	117,260.65	-2.728	10.667	11.672
0.06538471	38,223.99	103,778.94	-2.727	10.551	11.550
0.06581353	42,937.52	117,261.79	-2.721	10.668	11.672
0.06772129	3,881.55	9,390.62	-2.692	8.264	9.147
0.06798752	494.31	1,077.85	-2.688	6.203	6.983
0.06842301	4,313.78	10,492.02	-2.682	8.370	9.258
0.06849158	494.31	1,077.86	-2.681	6.203	6.983
0.06997327	2,509.90	5,940.16	-2.660	7.828	8.689
0.06997569	2,498.40	5,911.58	-2.660	7.823	8.685
0.09915559	42,959.58	117,325.05	-2.311	10.668	11.673
0.10025896	43,025.90	117,515.33	-2.300	10.670	11.674
0.10120459	4,296.13	10,446.92	-2.291	8.365	9.254
0.10206861	77,307.92	217,480.42	-2.282	11.256	12.290
0.10232039	1,581.97	3,657.91	-2.280	7.366	8.205
0.10262666	60,707.73	168,712.42	-2.277	11.014	12.036
0.10331044	1,930.11	4,507.88	-2.270	7.565	8.414
0.10338849	60,615.54	168,443.32	-2.269	11.012	12.034
0.10383965	12,085.32	30,961.16	-2.265	9.400	10.340
0.10462156	54,460.17	150,523.39	-2.257	10.905	11.922
0.10462397	54,293.77	150,040.32	-2.257	10.902	11.919
0.10699986	6,851.16	17,056.70	-2.235	8.832	9.744
0.10931033	7,637.50	19,118.82	-2.214	8.941	9.858
0.15847552	43,182.52	117,964.71	-1.842	10.673	11.678
0.15898465	76,643.97	215,518.87	-1.839	11.247	12.281
0.16951073	3,042.23	7,270.20	-1.775	8.020	8.892
0.25840755	7,645.71	19,140.43	-1.353	8.942	9.860
0.26302874	3,067.28	7,333.09	-1.335	8.029	8.900
0.26527004	12,081.00	30,949.56	-1.327	9.399	10.340
0.42981364	3,073.86	7,349.62	-0.844	8.031	8.902
1.10801132	30,774.57	82,645.36	0.103	10.334	11.322
1.10801132	30,774.57	82,645.36	0.103	10.334	11.322
1.12449932	30,775.07	82,646.76	0.117	10.334	11.322

N = 128

Table C-1-3. 1980 Refinery Data (Con't.)

----- Equipment Type=VALVE SERVICE=G -----

Measured Emission Rate(kg/hr)	Original TLV Screening Value (ppmv)	OVA Adjusted Screening Value (ppmv)	Natural Log of Emission Rate (kg/hr)	Natural Log of TLV Screening Value (ppmv)	Natural Log of OVA Screening Value (ppmv)
0.00001331	88.91	177.82	-11.227	4.488	5.181
0.00004011	6,639.19	16,502.81	-10.124	8.801	9.711
0.00005873	1,100.81	2,499.23	-9.743	7.004	7.824
0.00008684	28,723.41	76,869.15	-9.351	10.265	11.250
0.00008847	273.72	579.32	-9.333	5.612	6.362
0.00008852	82.39	164.13	-9.332	4.411	5.101
0.00012745	2,159.55	5,072.40	-8.968	7.678	8.532
0.00026556	4,000.01	9,691.89	-8.234	8.294	9.179
0.00037361	4,327.05	10,525.93	-7.892	8.373	9.262
0.00053159	2,786.15	6,628.77	-7.540	7.932	8.799
0.00056183	9,364.08	23,683.07	-7.484	9.145	10.073
0.00056516	9,364.16	23,683.30	-7.478	9.145	10.073
0.00077033	9,401.02	23,781.23	-7.169	9.149	10.077
0.00079547	3,094.87	7,402.39	-7.137	8.038	8.910
0.00111849	2,001.89	4,684.16	-6.796	7.602	8.452
0.00163767	10,341.06	26,285.19	-6.414	9.244	10.177
0.00164080	8,596.21	21,647.44	-6.413	9.059	9.983
0.00164247	10,364.87	26,348.78	-6.412	9.246	10.179
0.00230073	40,320.51	109,766.16	-6.075	10.605	11.606
0.00230829	3,972.31	9,621.40	-6.071	8.287	9.172
0.00329738	17,115.36	44,623.65	-5.715	9.748	10.706
0.00335895	87,956.92	249,053.14	-5.696	11.385	12.425
0.00339793	67,782.41	189,423.49	-5.685	11.124	12.152
0.00479241	4,409.66	10,737.12	-5.341	8.392	9.281
0.00525603	22,456.91	59,357.68	-5.248	10.019	10.991
0.00740749	48,426.60	133,057.03	-4.905	10.788	11.799
0.01034094	62,802.08	174,831.53	-4.572	11.048	12.072
0.01097916	57,627.00	159,730.80	-4.512	10.962	11.981
0.01099118	29,275.75	78,422.59	-4.511	10.285	11.270
0.01504923	44,686.05	122,282.85	-4.196	10.707	11.714
0.01514346	57,523.86	159,430.51	-4.190	10.960	11.979
0.01518837	57,458.07	159,238.97	-4.187	10.959	11.978
0.03115510	15,704.60	40,768.29	-3.469	9.662	10.616
0.04884917	10,348.47	26,304.97	-3.019	9.245	10.178
0.09161977	17,363.25	45,302.80	-2.390	9.762	10.721
0.09853946	44,817.44	122,660.53	-2.317	10.710	11.717
0.13483362	41,140.73	112,112.87	-2.004	10.625	11.627
0.13594593	10,484.70	26,668.84	-1.995	9.258	10.191

N = 38

Table C-1-3. 1980 Refinery Data (Con't.)

----- Equipment Type=VALVE SERVICE=LL_TPS -----					
Measured Emission Rate(kg/hr)	Original TLV Screening Value (ppmv)	OVA Adjusted Screening Value (ppmv)	Natural Log of Emission Rate (kg/hr)	Natural Log of TLV Screening Value (ppmv)	Natural Log of OVA Screening Value (ppmv)
0.00000225	4.59	7.91	-13.007	1.525	2.068
0.00001410	44.59	86.11	-11.170	3.797	4.456
0.00005956	62.56	122.91	-9.729	4.136	4.811
0.00008638	156.77	322.62	-9.357	5.055	5.776
0.00012792	21.47	39.97	-8.964	3.067	3.688
0.00012930	209.02	436.41	-8.953	5.342	6.079
0.00013197	305.66	650.53	-8.933	5.722	6.478
0.00018238	620.52	1,368.68	-8.609	6.431	7.222
0.00018238	620.52	1,368.68	-8.609	6.431	7.222
0.00018799	22.13	41.25	-8.579	3.097	3.720
0.00019149	84.34	168.23	-8.561	4.435	5.125
0.00026364	64.62	127.17	-8.241	4.169	4.846
0.00027025	976.13	2,202.77	-8.216	6.884	7.697
0.00027125	5,330.54	13,104.08	-8.212	8.581	9.481
0.00039603	484.14	1,054.57	-7.834	6.182	6.961
0.00056453	1,162.25	2,645.96	-7.480	7.058	7.881
0.00060409	9,829.56	24,921.22	-7.412	9.193	10.123
0.00075854	8,440.85	21,236.66	-7.184	9.041	9.963
0.00082319	10.05	18.01	-7.102	2.308	2.891
0.00083585	984.52	2,222.66	-7.087	6.892	7.706
0.00085249	3,206.69	7,683.59	-7.067	8.073	8.947
0.00113007	1,153.61	2,625.30	-6.785	7.051	7.873
0.00118193	10.03	17.96	-6.741	2.305	2.888
0.00120220	3,324.54	7,980.47	-6.724	8.109	8.985
0.00123419	9,979.00	25,319.36	-6.697	9.208	10.139
0.00163290	4,540.59	11,072.23	-6.417	8.421	9.312
0.00168838	1,363.36	3,128.89	-6.384	7.218	8.048
0.00170950	1,796.41	4,180.46	-6.372	7.494	8.338
0.00179606	3,953.18	9,572.75	-6.322	8.282	9.167
0.00241099	5,398.93	13,280.75	-6.028	8.594	9.494
0.00241192	860.44	1,929.39	-6.027	6.757	7.565
0.00243467	3,361.20	8,072.96	-6.018	8.120	8.996
0.00247077	3,354.55	8,056.16	-6.003	8.118	8.994
0.00247366	8,515.22	21,433.26	-6.002	9.050	9.973
0.00248176	3,998.89	9,689.06	-5.999	8.294	9.179
0.00249558	8,515.54	21,434.09	-5.993	9.050	9.973
0.00255458	1,013.43	2,291.28	-5.970	6.921	7.737
0.00341580	39,058.18	106,159.28	-5.679	10.573	11.573
0.00348074	33,787.34	91,164.47	-5.661	10.428	11.420
0.00349794	54,274.02	149,982.99	-5.656	10.902	11.918
0.00353072	8,527.25	21,465.06	-5.646	9.051	9.974
0.00353574	30,014.01	80,501.23	-5.645	10.309	11.296
0.00355244	1,381.43	3,172.46	-5.640	7.231	8.062
0.00357339	1,381.46	3,172.54	-5.634	7.231	8.062
0.00357551	15,739.47	40,863.36	-5.634	9.664	10.618

Table C-1-3. 1980 Refinery Data (Con't.)

----- Equipment Type=VALVE SERVICE=LL_TPS -----
 (continued)

Measured Emission Rate(kg/hr)	Original TLV Screening Value (ppmv)	OVA Adjusted Screening Value (ppmv)	Natural Log of Emission Rate (kg/hr)	Natural Log of TLV Screening Value (ppmv)	Natural Log of OVA Screening Value (ppmv)
0.00485006	8,625.65	21,725.33	-5.329	9.062	9.986
0.00491615	3,398.24	8,166.42	-5.315	8.131	9.008
0.00491615	3,398.24	8,166.42	-5.315	8.131	9.008
0.00493071	3,391.35	8,149.01	-5.312	8.129	9.006
0.00495259	1,383.25	3,176.85	-5.308	7.232	8.064
0.00516794	9,994.91	25,361.77	-5.265	9.210	10.141
0.00729950	8,551.85	21,530.11	-4.920	9.054	9.977
0.00736431	8,534.69	21,484.75	-4.911	9.052	9.975
0.00739766	1,176.57	2,680.21	-4.907	7.070	7.894
0.00755167	86,029.82	243,324.55	-4.886	11.362	12.402
0.00758374	2,932.48	6,994.95	-4.882	7.984	8.853
0.00758440	24,845.17	66,005.77	-4.882	10.120	11.097
0.00759940	13,655.17	35,199.01	-4.880	9.522	10.469
0.00772423	5,502.03	13,547.27	-4.863	8.613	9.514
0.01046618	86,317.33	244,178.82	-4.560	11.366	12.406
0.01047971	73,754.07	206,991.10	-4.558	11.208	12.240
0.01060438	8,547.05	21,517.41	-4.546	9.053	9.977
0.01066692	8,547.24	21,517.93	-4.541	9.053	9.977
0.01079315	8,547.64	21,518.97	-4.529	9.053	9.977
0.01127245	6,475.35	16,075.28	-4.485	8.776	9.685
0.01166120	5,355.65	13,168.93	-4.451	8.586	9.486
0.01474084	8,540.75	21,500.76	-4.217	9.053	9.976
0.01570609	29,161.44	78,100.99	-4.154	10.281	11.266
0.01605400	24,817.50	65,928.55	-4.132	10.119	11.096
0.02334577	7,507.70	18,777.67	-3.757	8.924	9.840
0.02368390	5,459.20	13,436.52	-3.743	8.605	9.506
0.02368390	5,459.20	13,436.52	-3.743	8.605	9.506
0.03207526	21,746.78	57,387.63	-3.440	9.987	10.958
0.04684899	47,238.27	129,629.48	-3.061	10.763	11.772
0.06870371	62,845.47	174,958.43	-2.678	11.048	12.072
0.10218383	62,944.53	175,248.12	-2.281	11.050	12.074
0.13512360	62,501.44	173,952.50	-2.002	11.043	12.067

N = 77

Table C-1-3. 1980 Refinery Data (Con't.)

----- Equipment Type=V_CS SERVICE=HYDRO -----

Measured Emission Rate(kg/hr)	Original TLV Screening Value (ppmv)	OVA Adjusted Screening Value (ppmv)	Natural Log of Emission Rate (kg/hr)	Natural Log of TLV Screening Value (ppmv)	Natural Log of OVA Screening Value (ppmv)
0.00000026	499.50	1,089.76	-15.164	6.214	6.994
0.00001464	33,440.21	90,180.89	-11.132	10.418	11.410
0.00002100	354.70	760.60	-10.771	5.871	6.634
0.00002104	1,197.44	2,730.17	-10.769	7.088	7.912
0.00002118	1,974.09	4,615.83	-10.762	7.588	8.437
0.00002933	33,494.85	90,335.66	-10.437	10.419	11.411
0.00003021	7,191.76	17,948.51	-10.407	8.881	9.795
0.00004536	253.47	534.39	-10.001	5.535	6.281
0.00012180	28,416.27	76,005.97	-9.013	10.255	11.239
0.00012180	28,416.27	76,005.97	-9.013	10.255	11.239
0.00012252	28,416.66	76,007.07	-9.007	10.255	11.239
0.00018123	95,583.08	271,783.91	-8.616	11.468	12.513
0.00025613	95,116.75	270,391.26	-8.270	11.463	12.508
0.00026043	4,052.53	9,825.60	-8.253	8.307	9.193
0.00041109	141.22	289.09	-7.797	4.950	5.667
0.00054874	95,287.08	270,899.89	-7.508	11.465	12.510
0.00056055	3,638.51	8,773.98	-7.487	8.199	9.080
0.00110337	28,727.31	76,880.12	-6.809	10.266	11.250
0.00110661	28,727.51	76,880.68	-6.806	10.266	11.250
0.00111311	28,727.91	76,881.80	-6.801	10.266	11.250
0.00118994	1,204.72	2,747.61	-6.734	7.094	7.918
0.00170959	10,318.68	26,225.43	-6.371	9.242	10.174
0.00235967	8,602.88	21,665.09	-6.049	9.060	9.983
0.00509039	94,269.02	267,860.46	-5.280	11.454	12.498
0.00706640	95,751.81	272,287.91	-4.952	11.470	12.515
0.00710793	95,753.13	272,291.86	-4.947	11.470	12.515
0.00712880	95,753.80	272,293.84	-4.944	11.470	12.515
0.01037369	95,729.11	272,220.09	-4.568	11.469	12.514
0.01040414	95,729.77	272,222.06	-4.566	11.469	12.514
0.01046548	95,621.82	271,899.63	-4.560	11.468	12.513
0.01049601	95,731.75	272,227.99	-4.557	11.469	12.514
0.01559018	95,711.47	272,167.42	-4.161	11.469	12.514
0.02089894	95,777.39	272,364.32	-3.868	11.470	12.515
0.02102181	95,778.71	272,368.27	-3.862	11.470	12.515
0.02114537	95,780.04	272,372.22	-3.856	11.470	12.515
0.02120783	95,671.37	272,047.64	-3.853	11.469	12.514
0.02133247	95,672.91	272,052.24	-3.848	11.469	12.514
0.03262723	95,877.79	272,664.22	-3.423	11.471	12.516
0.03337807	10,367.31	26,355.28	-3.400	9.246	10.179
0.04530855	95,188.17	270,604.54	-3.094	11.464	12.508
0.04570873	95,190.15	270,610.43	-3.085	11.464	12.508
0.04584365	95,082.37	270,288.60	-3.083	11.462	12.507
0.06482435	29,370.14	78,688.21	-2.736	10.288	11.273
0.06483958	74,453.14	209,052.45	-2.736	11.218	12.250
0.06535400	95,270.18	270,849.44	-2.728	11.464	12.509

Table C-1-3. 1980 Refinery Data (Con't.)

----- Equipment Type=V_CS SERVICE=HYDRO -----
 (continued)

Measured Emission Rate(kg/hr)	Original TLV Screening Value (ppmv)	OVA Adjusted Screening Value (ppmv)	Natural Log of Emission Rate (kg/hr)	Natural Log of TLV Screening Value (ppmv)	Natural Log of OVA Screening Value (ppmv)
0.06612569	95,164.29	270,533.21	-2.716	11.463	12.508
0.06612569	95,164.29	270,533.21	-2.716	11.463	12.508

N = 47

Table C-1-4. REGRESSION STATISTICS FOR THE 1980 AND 1993 REFINERY DATA

Equipment		Facility Type ^a	Sample Size	Intercept (b ₀)	Slope (b ₁)	Root Mean Square Error (RMSE)	Coefficient of Simple Determination (R ²)	Scale Bias Correction Factor (SBCF)	Mean In Screening Value	Sum of Squared Deviations from the Mean In Screening Value
Type	Service									
Connector	All	REF80	38	-12.07497	0.759	1.011	0.5333	1.6334	6.69239	72.8674
		REF93	28	-17.45599	1.007	1.851	0.7233	4.7774	7.04812	229.6503
Pump	Light Liquid ^b	REF80	128	-10.02998	0.676	1.726	0.3371	4.3133	8.36906	417.3760
		REF93	30	-10.07607	0.419	1.579	0.3281	3.1882	6.71261	194.3916
Valve	Gas	REF80	38	-14.93176	0.960	1.751	0.4788	4.2109	9.15822	109.8584
		REF93	50	-13.94624	0.675	1.245	0.5725	2.1124	6.22836	218.6160
Valve	Light Liquid ^c	REF80	77	-11.46481	0.678	1.230	0.6145	2.0935	7.98760	393.2046
		REF93	82	-14.17854	0.783	1.453	0.6340	2.7995	6.56265	476.8908

^aFacility types are: REF80=1980 refinery data and REF93=1993 refinery data

^bFor light liquid pumps, the 1980 refinery data include two-phase stream pumps, gas compressors, gas pressure relief valves, and light liquid pumps.

^cFor light liquid valves, the 1980 refinery data include two-phase stream valves and light liquid valves.

APPENDIX C: ATTACHMENT 2

This attachment lists the bagging data used to develop the pegged emission rates for the combined 1993 petroleum industry data in table C-2-1. Table C-2-2 lists summary statistics for the 10,000 ppmv pegged emission rates and Table C-2-3 lists summary statistics for the 100,000 ppmv pegged emission rates.

TABLE C-2-1. BAGGING DATA USED TO DEVELOP PEGGED EMISSION RATES

Plant Type	Initial Screening Value (ppmv)	Final Screening Value (ppmv)	Measured Emission Rate (kg/hr)	Natural Log of Emission Rate (kg/hr)
----- Equipment Type=COMPRESSOR SERVICE=G -----				
ONOFF	100000	100000	0.02448289939	-3.710
ONOFF	100000	100000	0.03493150685	-3.354
N = 2				
----- Equipment Type=COMPRESSOR SERVICE=LL -----				
ONOFF	100000	100000	0.00101197496	-6.896
N = 1				
----- Equipment Type=CONNECTOR SERVICE=G -----				
ONOFF	5000	10000	0.00001270072	-11.274
ONOFF	70000	70000	0.00009344099	-9.278
ONOFF	10000	10000	0.00015104781	-8.798
REF	100000	100000	0.00019804046	-8.527
ONOFF	100000	100000	0.00031933231	-8.049
MT	100000	100000	0.00035811031	-7.935
ONOFF	100000	100000	0.00045858659	-7.687
ONOFF	100000	100000	0.00081556745	-7.112
REF	11000	11000	0.00094198494	-6.968
REF	91000	91000	0.00125365146	-6.682
REF	100000	100000	0.00199886601	-6.215
REF	48000	40000	0.00220312075	-6.118
MT	100000	100000	0.00277519731	-5.887
ONOFF	10000	10000	0.00287262996	-5.853
ONOFF	10000	10000	0.00291935045	-5.836
ONOFF	100000	45000	0.00297922526	-5.816
ONOFF	100000	100000	0.00371632042	-5.595
ONOFF	10000	100000	0.00515513018	-5.268
ONOFF	10000	10000	0.00559920167	-5.185
ONOFF	100000	100000	0.00675269890	-4.998
ONOFF	100000	100000	0.00760364692	-4.879
ONOFF	100000	100000	0.00877029847	-4.736
ONOFF	100000	100000	0.01064229339	-4.543
ONOFF	100000	100000	0.01651047809	-4.104
REF	100000	100000	0.02005624603	-3.909
ONOFF	10000	10000	0.03374716502	-3.389
REF	100000	100000	0.03482899392	-3.357
REF	12500	29000	0.03548852400	-3.339
REF	55000	55000	0.05391454232	-2.920

Table C-2-1. BAGGING DATA USED TO DEVELOP PEGGED EMISSION RATES
(CONTINUED)

Plant Type	Initial Screening Value (ppmv)	Final Screening Value (ppmv)	Measured Emission Rate (kg/hr)	Natural Log of Emission Rate (kg/hr)
ONOFF	100000	100000	0.06664383562	-2.708
ONOFF	100000	100000	0.10322462125	-2.271
N = 31				
----- Equipment Type=CONNECTOR SERVICE=HL -----				
REF	76650	21900	0.01362968339	-4.296
REF	1700	1200	0.03207475279	-3.440
N = 2				
----- Equipment Type=CONNECTOR SERVICE=LL -----				
ONOFF	100000	100000	0.00000408237	-12.409
ONOFF	10000	5000	0.00001859748	-10.892
REF	21060	17550	0.00001880613	-10.881
ONOFF	10000	10000	0.00002494784	-10.599
REF	16500	27500	0.00006329946	-9.668
ONOFF	10000	10000	0.00006441078	-9.650
ONOFF	100000	100000	0.00010977048	-9.117
ONOFF	10000	10000	0.00027215821	-8.209
ONOFF	100000	100000	0.00038328949	-7.867
ONOFF	100000	100000	0.00040143337	-7.820
REF	48000	100000	0.00062002177	-7.386
ONOFF	10000	10000	0.00063594303	-7.360
REF	90000	90000	0.00082713417	-7.098
ONOFF	100000	100000	0.00088768938	-7.027
ONOFF	10000	10000	0.00092760591	-6.983
REF	72000	80000	0.00117463485	-6.747
REF	117000	117000	0.00119817654	-6.727
ONOFF	4000	10000	0.00153451873	-6.480
ONOFF	10000	10000	0.00185475823	-6.290
ONOFF	100000	100000	0.00198267259	-6.223
ONOFF	10000	10000	0.00259548217	-5.954
REF	100000	100000	0.00275909462	-5.893
REF	47000	47000	0.00283806586	-5.865
REF	117000	117000	0.00303991654	-5.796
REF	49700	56000	0.00337970607	-5.690
ONOFF	10000	10000	0.00383470924	-5.564
ONOFF	5000	10000	0.00396035562	-5.531
ONOFF	100000	50000	0.00445613717	-5.413
ONOFF	100000	100000	0.00489748707	-5.319
ONOFF	100000	100000	0.00597387281	-5.120
REF	90000	90000	0.00711648372	-4.945
ONOFF	10000	10000	0.01034019777	-4.572
ONOFF	100000	100000	0.01055701715	-4.551

Table C-2-1. BAGGING DATA USED TO DEVELOP PEGGED EMISSION RATES
(CONTINUED)

Plant Type	Initial Screening Value (ppmv)	Final Screening Value (ppmv)	Measured Emission Rate (kg/hr)	Natural Log of Emission Rate (kg/hr)
ONOFF	10000	10000	0.01699718770	-4.075
REF	20000	35000	0.02082463939	-3.872
ONOFF	100000	100000	0.02084550485	-3.871
ONOFF	100000	100000	0.02378708156	-3.739
REF	66000	66000	0.02872992833	-3.550
ONOFF	100000	100000	0.05975551120	-2.817
ONOFF	100000	100000	0.07526807584	-2.587
ONOFF	40000	50000	0.15713462760	-1.851
N = 41				
----- Equipment Type=DUMP LEVER ARM SERVICE=G -----				
ONOFF	100000	100000	0.39765218180	-0.922
N = 1				
----- Equipment Type=FLANGE SERVICE=G -----				
ONOFF	10000	10000	0.00000544316	-12.121
REF	86000	86000	0.00007830899	-9.455
ONOFF	10000	8000	0.00030254922	-8.103
ONOFF	4000	10000	0.00045722580	-7.690
ONOFF	100000	100000	0.00241857933	-6.025
ONOFF	10000	9000	0.00292252563	-5.835
REF	86000	86000	0.00374639390	-5.587
ONOFF	100000	90000	0.00613217817	-5.094
ONOFF	100000	100000	0.01279370407	-4.359
ONOFF	100000	100000	0.01363467296	-4.295
ONOFF	100000	100000	0.01780277601	-4.028
ONOFF	100000	100000	0.01851673773	-3.989
REF	100000	100000	0.02487798240	-3.694
ONOFF	100000	100000	0.03357615894	-3.394
ONOFF	100000	20000	0.04434137712	-3.116
ONOFF	100000	100000	0.06712600925	-2.701
ONOFF	100000	100000	0.09028894130	-2.405
ONOFF	100000	100000	0.10636124467	-2.241
N = 18				
----- Equipment Type=FLANGE SERVICE=LL -----				
ONOFF	100000	100000	0.00015603738	-8.765
REF	18000	22500	0.00095309807	-6.956
REF	30000	40000	0.00125641840	-6.679
REF	13200	9900	0.00344683843	-5.670

Table C-2-1. BAGGING DATA USED TO DEVELOP PEGGED EMISSION RATES
(CONTINUED)

Plant Type	Initial Screening Value (ppmv)	Final Screening Value (ppmv)	Measured Emission Rate (kg/hr)	Natural Log of Emission Rate (kg/hr)
ONOFF	100000	60000	0.02859657081	-3.554
ONOFF	100000	100000	0.17639481085	-1.735
N = 6				
----- Equipment Type=INSTRUMENT SERVICE=G -----				
ONOFF	30000	30000	0.00028259095	-8.172
ONOFF	100000	100000	0.01809307811	-4.012
N = 2				
----- Equipment Type=INSTRUMENT SERVICE=LL -----				
ONOFF	100000	100000	0.00345005897	-5.669
N = 1				
----- Equipment Type=LOADARM SERVICE=G -----				
MT	100000	100000	0.00021052799	-8.466
MT	400000	400000	0.04320148780	-3.142
MT	310000	310000	0.04397804590	-3.124
MT	7200	24000	0.04716501860	-3.054
N = 4				
----- Equipment Type=OEL SERVICE=G -----				
ONOFF	100000	100000	0.00000272158	-12.814
ONOFF	3000	10000	0.00001360791	-11.205
ONOFF	200	10000	0.00001769028	-10.942
ONOFF	10000	10000	0.00001814388	-10.917
ONOFF	10000	10000	0.00003039100	-10.401
REF	13400	16750	0.00004146875	-10.091
ONOFF	20000	15000	0.00004853488	-9.933
ONOFF	10000	10000	0.00005080287	-9.888
ONOFF	3000	10000	0.00007983308	-9.436
ONOFF	10000	10000	0.00008935861	-9.323
ONOFF	10000	10000	0.00009026581	-9.313
REF	100000	100000	0.00013893677	-8.881
ONOFF	9000	10000	0.00014877982	-8.813
ONOFF	10000	100000	0.00020547945	-8.490
REF	6000	10000	0.00023758051	-8.345
ONOFF	12000	15000	0.00029257008	-8.137

Table C-2-1. BAGGING DATA USED TO DEVELOP PEGGED EMISSION RATES
(CONTINUED)

Plant Type	Initial Screening Value (ppmv)	Final Screening Value (ppmv)	Measured Emission Rate (kg/hr)	Natural Log of Emission Rate (kg/hr)
ONOFF	100000	100000	0.00046901932	-7.665
ONOFF	35000	20000	0.00057652182	-7.458
ONOFF	10000	10000	0.00059194412	-7.432
ONOFF	100000	100000	0.00072167287	-7.234
REF	50000	40000	0.00087367323	-7.043
ONOFF	100000	100000	0.00094847138	-6.961
ONOFF	100000	100000	0.00100244942	-6.905
ONOFF	10000	10000	0.00142610904	-6.553
ONOFF	10000	9000	0.00148326227	-6.514
ONOFF	70000	70000	0.00203392906	-6.198
ONOFF	15000	15000	0.00229792253	-6.076
REF	119000	119000	0.00267976050	-5.922
ONOFF	100000	100000	0.00350403701	-5.654
ONOFF	40000	100000	0.00398666425	-5.525
REF	89000	89000	0.00412528350	-5.491
ONOFF	100000	100000	0.00440850948	-5.424
ONOFF	100000	100000	0.00509843055	-5.279
ONOFF	10000	10000	0.00556200671	-5.192
REF	110000	110000	0.00582781457	-5.145
ONOFF	10000	10000	0.00610314796	-5.099
ONOFF	100000	100000	0.00673001905	-5.001
ONOFF	100000	100000	0.00783997097	-4.849
ONOFF	100000	80000	0.00808309897	-4.818
ONOFF	100000	100000	0.00899074662	-4.712
REF	140000	140000	0.01182844961	-4.437
ONOFF	100000	100000	0.01357071578	-4.300
REF	140000	140000	0.01958495872	-3.933
ONOFF	100000	100000	0.02699718770	-3.612
ONOFF	100000	100000	0.04810033566	-3.034
ONOFF	100000	100000	0.05125374218	-2.971
ONOFF	100000	100000	0.05756735916	-2.855
ONOFF	100000	100000	0.06938129366	-2.668
ONOFF	100000	100000	0.15146738637	-1.887
ONOFF	100000	100000	0.19622017600	-1.629
ONOFF	100000	100000	0.72652136442	-0.319
N = 51				
----- Equipment Type=OEL SERVICE=HL -----				
ONOFF	10000	8000	0.00003991654	-10.129
REF	15000	16000	0.00018571169	-8.591
ONOFF	10000	10000	0.00264628504	-5.935
REF	700	700	0.00467341014	-5.366
N = 4				

Table C-2-1. BAGGING DATA USED TO DEVELOP PEGGED EMISSION RATES
(CONTINUED)

Plant Type	Initial Screening Value (ppmv)	Final Screening Value (ppmv)	Measured Emission Rate (kg/hr)	Natural Log of Emission Rate (kg/hr)
----- Equipment Type=OEL SERVICE=LL -----				
ONOFF	20000	100000	0.00003538057	-10.249
REF	13200	16500	0.00009666606	-9.244
ONOFF	20000	3000	0.00011385285	-9.081
ONOFF	30000	40000	0.00013063594	-8.943
ONOFF	2000	10000	0.00043000998	-7.752
ONOFF	10000	8000	0.00043499955	-7.740
REF	12000	13000	0.00056373038	-7.481
ONOFF	6000	20000	0.00085366960	-7.066
REF	100000	100000	0.00085947564	-7.059
REF	14000	12000	0.00092007620	-6.991
REF	95000	100000	0.00101356255	-6.894
ONOFF	10000	1000	0.00117753788	-6.744
ONOFF	40000	35000	0.00120112492	-6.724
MT	300000	300000	0.00217168647	-6.132
ONOFF	20000	20000	0.00219268802	-6.123
MT	136000	119000	0.00292179987	-5.836
ONOFF	50000	35000	0.00361471469	-5.623
ONOFF	100000	100000	0.00493286764	-5.312
ONOFF	80000	60000	0.00594257462	-5.126
ONOFF	100000	100000	0.00672366869	-5.002
ONOFF	50000	100000	0.00678853307	-4.993
ONOFF	100000	30000	0.00804363603	-4.823
ONOFF	100000	100000	0.00847319242	-4.771
REF	20000	33600	0.00883470924	-4.729
ONOFF	10000	10000	0.00924929692	-4.683
ONOFF	10000	10000	0.01178853307	-4.441
ONOFF	100000	100000	0.01185702622	-4.435
REF	73000	73000	0.01350811939	-4.304
ONOFF	100000	100000	0.01985711694	-3.919
ONOFF	100000	100000	0.02174907013	-3.828
REF	140000	140000	0.04261680123	-3.156
ONOFF	100000	100000	0.07331080468	-2.613
N = 32				
----- Equipment Type=OTHER SERVICE=G -----				
MT	100000	100000	0.01708926789	-4.069
MT	100000	100000	0.01809353171	-4.012
N = 2				
----- Equipment Type=PRV SERVICE=G -----				
ONOFF	100000	100000	0.02052209018	-3.886

Table C-2-1. BAGGING DATA USED TO DEVELOP PEGGED EMISSION RATES
(CONTINUED)

Plant Type	Initial Screening Value (ppmv)	Final Screening Value (ppmv)	Measured Emission Rate (kg/hr)	Natural Log of Emission Rate (kg/hr)
ONOFF	100000	100000	0.36418670054	-1.010
N = 2				
----- Equipment Type=PUMP SERVICE=LL -----				
REF	35000	21000	0.00082055702	-7.106
REF	40500	27000	0.00086514560	-7.053
REF	109000	98100	0.00105651819	-6.853
REF	76500	90000	0.00106527261	-6.845
REF	21000	25000	0.00119445704	-6.730
MT	10000	12000	0.00176567178	-6.339
REF	56000	28000	0.00958087635	-4.648
REF	12000	16000	0.00968248208	-4.637
REF	18000	17400	0.03439081920	-3.370
REF	77000	47000	0.03876077293	-3.250
REF	100000	100000	0.16085911276	-1.827
REF	100000	100000	1.25088451420	0.224
N = 12				
----- Equipment Type=STUFFING BOX SERVICE=LL -----				
ONOFF	10000	500	0.00035698086	-7.938
ONOFF	10000	10000	0.00215186428	-6.141
N = 2				
----- Equipment Type=VALVE SERVICE=G -----				
ONOFF	100000	100000	0.00000725755	-11.833
ONOFF	1000	10000	0.00001814388	-10.917
ONOFF	10000	10000	0.00002585503	-10.563
ONOFF	60000	10000	0.00002585503	-10.563
ONOFF	100000	100000	0.00002676222	-10.529
ONOFF	100000	100000	0.00004127733	-10.095
ONOFF	10000	10000	0.00005171006	-9.870
ONOFF	100000	100000	0.00005488524	-9.810
ONOFF	100000	3000	0.00008754423	-9.343
REF	20000	2000	0.00023997097	-8.335
ONOFF	100000	100000	0.00026399347	-8.240
ONOFF	10000	10000	0.00026852944	-8.223
ONOFF	15000	15000	0.00029257008	-8.137
ONOFF	100000	100000	0.00031706432	-8.056
REF	22500	22500	0.00035323415	-7.948
ONOFF	10000	10000	0.00038555747	-7.861
REF	18000	15000	0.00038567541	-7.861

Table C-2-1. BAGGING DATA USED TO DEVELOP PEGGED EMISSION RATES
(CONTINUED)

Plant Type	Initial Screening Value (ppmv)	Final Screening Value (ppmv)	Measured Emission Rate (kg/hr)	Natural Log of Emission Rate (kg/hr)
REF	65700	65700	0.00060437268	-7.411
REF	100000	100000	0.00060967976	-7.403
ONOFF	10000	10000	0.00064002540	-7.354
ONOFF	100000	100000	0.00068946748	-7.280
ONOFF	100000	20000	0.00069717863	-7.268
REF	80000	48000	0.00085747981	-7.062
ONOFF	70000	70000	0.00090220448	-7.011
ONOFF	30000	10000	0.00094166742	-6.968
ONOFF	15000	15000	0.00094484260	-6.964
ONOFF	10000	10000	0.00095799692	-6.951
ONOFF	100000	100000	0.00104644834	-6.862
ONOFF	50000	40000	0.00109815840	-6.814
ONOFF	10000	10000	0.00121291844	-6.715
ONOFF	7500	10000	0.00122335117	-6.706
REF	100000	100000	0.00128871451	-6.654
ONOFF	100000	100000	0.00128957634	-6.653
ONOFF	100000	100000	0.00133085367	-6.622
REF	100000	100000	0.00160963440	-6.432
ONOFF	40000	40000	0.00171278236	-6.370
REF	109000	109000	0.00178594756	-6.328
ONOFF	10000	10000	0.00181348090	-6.313
ONOFF	10000	10000	0.00199129094	-6.219
REF	100000	100000	0.00205130182	-6.189
ONOFF	60000	100000	0.00206341286	-6.183
ONOFF	100000	100000	0.00208563912	-6.173
ONOFF	25000	40000	0.00233194230	-6.061
ONOFF	50000	40000	0.00269255194	-5.917
MT	300000	300000	0.00277487980	-5.887
ONOFF	100000	100000	0.00287081557	-5.853
REF	67000	100000	0.00287548762	-5.852
ONOFF	100000	100000	0.00300553388	-5.807
ONOFF	100000	100000	0.00333167014	-5.704
ONOFF	100000	100000	0.00336795791	-5.693
REF	77000	77000	0.00341059603	-5.681
REF	80000	80000	0.00349872993	-5.655
ONOFF	100000	100000	0.00377438084	-5.580
REF	58000	35000	0.00417118752	-5.480
REF	100000	100000	0.00479905652	-5.339
REF	100000	100000	0.00497732015	-5.303
ONOFF	100000	100000	0.00498639209	-5.301
REF	78000	78000	0.00514197587	-5.270
ONOFF	100000	100000	0.00520366506	-5.258
ONOFF	100000	100000	0.00543227796	-5.215
ONOFF	10000	10000	0.00546720494	-5.209
REF	100000	100000	0.00554839880	-5.194
ONOFF	100000	100000	0.00594393541	-5.125
ONOFF	10000	10000	0.00630545224	-5.066
ONOFF	100000	100000	0.00660664066	-5.020
REF	70000	63000	0.00672094711	-5.003

Table C-2-1. BAGGING DATA USED TO DEVELOP PEGGED EMISSION RATES
(CONTINUED)

Plant Type	Initial Screening Value (ppmv)	Final Screening Value (ppmv)	Measured Emission Rate (kg/hr)	Natural Log of Emission Rate (kg/hr)
ONOFF	80000	100000	0.00687607729	-4.980
ONOFF	100000	100000	0.00845640933	-4.773
ONOFF	80000	100000	0.00850403701	-4.767
REF	100000	100000	0.00879071033	-4.734
REF	90000	90000	0.00915767033	-4.693
ONOFF	100000	100000	0.00999909281	-4.605
REF	100000	100000	0.01077791890	-4.530
ONOFF	100000	100000	0.01084051529	-4.524
ONOFF	10000	10000	0.01150231334	-4.465
ONOFF	100000	100000	0.01338700898	-4.313
REF	50000	100000	0.01343826544	-4.310
REF	16000	80000	0.01372947473	-4.288
ONOFF	100000	100000	0.01451056881	-4.233
ONOFF	50000	50000	0.01612628141	-4.127
ONOFF	30000	100000	0.01659711512	-4.099
ONOFF	100000	100000	0.01664837159	-4.095
REF	58000	58000	0.01690556110	-4.080
REF	120000	120000	0.01879887508	-3.974
ONOFF	100000	100000	0.01883380205	-3.972
ONOFF	100000	100000	0.02038374308	-3.893
ONOFF	100000	100000	0.02074389912	-3.876
ONOFF	100000	100000	0.02144924249	-3.842
ONOFF	100000	100000	0.02216048263	-3.809
ONOFF	100000	100000	0.02497323778	-3.690
REF	71400	71400	0.02521500499	-3.680
ONOFF	100000	100000	0.02522135535	-3.680
ONOFF	100000	100000	0.02819150866	-3.569
ONOFF	100000	100000	0.03083597932	-3.479
ONOFF	100000	100000	0.03347137803	-3.397
ONOFF	100000	100000	0.03378118480	-3.388
ONOFF	100000	100000	0.03389685204	-3.384
ONOFF	100000	100000	0.03527669418	-3.345
ONOFF	100000	100000	0.03595482174	-3.325
ONOFF	100000	100000	0.03649097342	-3.311
ONOFF	100000	100000	0.03771114941	-3.278
ONOFF	100000	100000	0.03832713417	-3.262
ONOFF	5000	10000	0.04127914361	-3.187
ONOFF	100000	100000	0.04416220630	-3.120
ONOFF	100000	100000	0.04438764402	-3.115
ONOFF	60000	70000	0.04505624603	-3.100
ONOFF	100000	100000	0.04937176812	-3.008
ONOFF	10000	10000	0.05139208927	-2.968
ONOFF	100000	100000	0.05296924612	-2.938
ONOFF	100000	100000	0.05525764311	-2.896
ONOFF	100000	100000	0.06018007802	-2.810
MT	90000	300000	0.06055973873	-2.804
ONOFF	10000	10000	0.06589585412	-2.720
ONOFF	10000	10000	0.06919123651	-2.671
ONOFF	10000	100000	0.06986891046	-2.661

Table C-2-1. BAGGING DATA USED TO DEVELOP PEGGED EMISSION RATES
(CONTINUED)

Plant Type	Initial Screening Value (ppmv)	Final Screening Value (ppmv)	Measured Emission Rate (kg/hr)	Natural Log of Emission Rate (kg/hr)
ONOFF	100000	100000	0.07176086365	-2.634
REF	100000	100000	0.07735190057	-2.559
ONOFF	100000	100000	0.08639118207	-2.449
ONOFF	10000	10000	0.08908826998	-2.418
ONOFF	100000	100000	0.09582463939	-2.345
ONOFF	100000	100000	0.15789757779	-1.846
ONOFF	100000	100000	0.18449242493	-1.690
ONOFF	100000	100000	0.18958677311	-1.663
ONOFF	100000	100000	0.19712873084	-1.624
ONOFF	100000	100000	0.21433094439	-1.540
ONOFF	100000	100000	0.22602739726	-1.487
ONOFF	100000	100000	0.27724439808	-1.283
ONOFF	10000	10000	0.28369636215	-1.260
ONOFF	100000	100000	0.28827360973	-1.244
ONOFF	100000	100000	0.38205751610	-0.962
ONOFF	100000	100000	0.44049986392	-0.820
ONOFF	100000	100000	0.81931597569	-0.199
ONOFF	100000	100000	1.13625011340	0.128
N = 133				
----- Equipment Type=VALVE SERVICE=HL -----				
REF	10000	16000	0.00043354350	-7.744
REF	11000	12000	0.00223700445	-6.103
N = 2				
----- Equipment Type=VALVE SERVICE=LL -----				
ONOFF	10000	10000	0.00002404064	-10.636
ONOFF	10000	10000	0.00002449424	-10.617
ONOFF	100000	100000	0.00003447337	-10.275
REF	80000	32000	0.00009142702	-9.300
ONOFF	15000	20000	0.00010342012	-9.177
REF	16000	32000	0.00013744443	-8.892
ONOFF	10000	4000	0.00018279960	-8.607
MT	19800	22000	0.00023388370	-8.361
REF	13500	10800	0.00025930781	-8.257
REF	42000	28000	0.00035377846	-7.947
MT	17600	26400	0.00043848771	-7.732
REF	49500	36000	0.00044372675	-7.720
REF	70000	35000	0.00045913091	-7.686
REF	18000	22500	0.00046035562	-7.684
ONOFF	10000	10000	0.00050122471	-7.598
ONOFF	20000	20000	0.00052617255	-7.550
ONOFF	10000	10000	0.00056563549	-7.478
REF	2000	10000	0.00056713236	-7.475

Table C-2-1. BAGGING DATA USED TO DEVELOP PEGGED EMISSION RATES
(CONTINUED)

Plant Type	Initial Screening Value (ppmv)	Final Screening Value (ppmv)	Measured Emission Rate (kg/hr)	Natural Log of Emission Rate (kg/hr)
REF	10000	24000	0.00059525538	-7.427
REF	24000	24000	0.00060782001	-7.406
ONOFF	100000	60000	0.00065091173	-7.337
ONOFF	30000	4000	0.00068220992	-7.290
ONOFF	20000	20000	0.00070443618	-7.258
ONOFF	10000	10000	0.00070488978	-7.257
ONOFF	70000	40000	0.00075932142	-7.183
REF	50000	30000	0.00095572893	-6.953
ONOFF	60000	50000	0.00102558287	-6.882
REF	11000	11000	0.00113353896	-6.782
REF	80000	80000	0.00134786356	-6.609
ONOFF	80000	100000	0.00135625510	-6.603
MT	10000	11984	0.00142805951	-6.551
REF	25000	18000	0.00153742175	-6.478
ONOFF	10000	10000	0.00168647374	-6.385
ONOFF	350	10000	0.00185929420	-6.288
ONOFF	20000	15000	0.00211829810	-6.157
ONOFF	40000	70000	0.00223351175	-6.104
ONOFF	10000	10000	0.00225936678	-6.093
ONOFF	10000	10000	0.00226753152	-6.089
ONOFF	100000	100000	0.00230064411	-6.075
ONOFF	50000	35000	0.00247028939	-6.003
REF	58000	58000	0.00307012610	-5.786
ONOFF	10000	9000	0.00325773383	-5.727
REF	70000	70000	0.00345051256	-5.669
ONOFF	9000	10000	0.00417490701	-5.479
ONOFF	90000	100000	0.00426290484	-5.458
ONOFF	100000	100000	0.00436587136	-5.434
ONOFF	10000	10000	0.00454277420	-5.394
ONOFF	100000	100000	0.00488886873	-5.321
REF	5000	40000	0.00500408237	-5.298
REF	70000	70000	0.00507983308	-5.282
ONOFF	100000	100000	0.00518234600	-5.262
ONOFF	100000	100000	0.00592896671	-5.128
ONOFF	10000	10000	0.00596117209	-5.122
REF	24500	27300	0.00601378935	-5.114
ONOFF	100000	100000	0.00647010796	-5.041
REF	131400	146000	0.00666334029	-5.011
REF	30000	70000	0.00844506940	-4.774
REF	55000	100000	0.00920847319	-4.688
ONOFF	100000	100000	0.01027941577	-4.578
ONOFF	100000	100000	0.01037285675	-4.569
ONOFF	10000	10000	0.01041458768	-4.565
ONOFF	10000	10000	0.01133221446	-4.480
ONOFF	10000	10000	0.01256146240	-4.377
REF	67000	67000	0.01319241586	-4.328
REF	140000	140000	0.01378798875	-4.284
ONOFF	10000	10000	0.01564138619	-4.158
REF	17000	34000	0.01730744806	-4.057

Table C-2-1. BAGGING DATA USED TO DEVELOP PEGGED EMISSION RATES
(CONTINUED)

Plant Type	Initial Screening Value (ppmv)	Final Screening Value (ppmv)	Measured Emission Rate (kg/hr)	Natural Log of Emission Rate (kg/hr)
ONOFF	100000	100000	0.01835979316	-3.998
REF	100000	100000	0.01882427651	-3.973
ONOFF	45000	45000	0.01897986029	-3.964
REF	76000	69850	0.02037603193	-3.893
REF	100000	100000	0.02065272612	-3.880
ONOFF	10000	10000	0.02356890139	-3.748
REF	87500	87500	0.02427696634	-3.718
REF	100000	100000	0.02519096435	-3.681
REF	39000	39000	0.02586999909	-3.655
ONOFF	100000	100000	0.02691508664	-3.615
REF	70000	70000	0.03012791436	-3.502
ONOFF	10000	10000	0.03019504672	-3.500
ONOFF	10000	10000	0.03919486528	-3.239
ONOFF	10000	10000	0.08274879797	-2.492
ONOFF	100000	100000	0.08523224168	-2.462
ONOFF	10000	10000	0.08567948834	-2.457
ONOFF	100000	100000	0.08933548036	-2.415
ONOFF	100000	100000	0.09434591309	-2.361
ONOFF	100000	100000	0.10369500136	-2.266
REF	70000	70000	0.18793885512	-1.672
ONOFF	100000	100000	0.38088768938	-0.965
N = 88				
----- Equipment Type=VENT SERVICE=G -----				
ONOFF	100000	100000	0.00012972875	-8.950
ONOFF	100000	100000	0.00851719133	-4.766
ONOFF	100000	100000	0.00923206024	-4.685
ONOFF	100000	100000	0.02947428105	-3.524
N = 4				
----- Equipment Type=VENT SERVICE=LL -----				
ONOFF	100000	100000	0.00005443164	-9.819
ONOFF	100000	100000	0.00027714778	-8.191
ONOFF	10000	10000	0.00117844507	-6.744
ONOFF	10000	10000	0.00200762043	-6.211
N = 4				

TABLE C-2-2. PEGGED VOC MASS EMISSION RATES AND 95 PERCENT CONFIDENCE INTERVALS FOR READINGS PEGGED AT 10,000 PPMV DEVELOPED FROM THE COMBINED 1993 REFINERY, MARKETING TERMINAL, AND OIL AND GAS PRODUCTION OPERATIONS DATA

Equipment Type/Service	Sample Size	Normal Statistic ^a (Probability of a Larger Normal Statistic)		Mean Natural Log Mass Emission Rate	Scale Bias Correction Factor	Lower 95 Percent Confidence Bound for Pegged Emission Rate (kg/hr)	Pegged Emission Rate (kg/hr)	Upper 95 Percent Confidence Bound for Pegged Emission Rate (kg/hr)
		Mass Emission Rate	In Mass Emission Rate					
Connector/All	74	0.5569 (0.0000)	0.9631 (0.0945)	-6.067	12.24	0.01668	0.02836	0.04821
Flange/All	24	0.6790 (0.0000)	0.9424 (0.1899)	-5.312	17.25	0.02877	0.08504	0.25141
Open-Ended Line/All	87	0.2597 (0.0000)	0.9819 (0.6620)	-6.374	17.78	0.01797	0.03031	0.05110
Pump/All	12	0.3985 (0.0000)	0.8640 (0.0519)	-4.869	9.63	0.01609	0.07395	0.33989
Valve/All	223	0.3740 (0.000)	0.9774 (0.1524)	-5.301	12.84	0.04741	0.06403	0.08648
Other ^b /All	25	0.4359 (0.0000)	0.9506 (0.2710)	-5.219	13.46	0.02665	0.07285	0.19914

^aThe Normal Statistic is generated by default from SAS--by default the Shapiro-Wilk statistic is calculated for sample sizes less than 2,000. Probabilities greater than 0.05 indicate a normal distribution.

^bThe "other" equipment type was developed from instruments, loading arms, pressure relief valves, stuffing boxes, vents, compressors, and dump lever arms. This "other" equipment type should be applied to any equipment other than connectors, flanges, open-ended lines, pumps, or valves.

TABLE C-2-3. PEGGED VOC MASS EMISSION RATES AND 95 PERCENT CONFIDENCE INTERVALS FOR READINGS PEGGED AT 100,000 PPMV DEVELOPED FROM THE COMBINED 1993 REFINERY, MARKETING TERMINAL, AND OIL AND GAS PRODUCTION OPERATIONS DATA

Equipment Type/Service	Sample Size	Normal Statistic ^a (Probability of a Larger Normal Statistic)		Mean Natural Log Mass Emission Rate	Scale Bias Correction Factor	Lower 95 Percent Confidence Bound for Pegged Emission Rate (kg/hr)	Pegged Emission Rate (kg/hr)	Upper 95 Percent Confidence Bound for Pegged Emission Rate (kg/hr)
		Mass Emission Rate	In Mass Emission Rate					
Connector/All	33	0.6405 (0.0000)	0.9579 (0.2747)	-5.739	9.25	0.01359	0.02974	0.06509
Flange/All	12	0.8101 (0.0106)	0.8653 (0.0539)	-3.969	4.47	0.02515	0.08439	0.28317
Open-Ended Line/All	36	0.3759 (0.0000)	0.9444 (0.0918)	-4.893	10.55	0.03672	0.07911	0.17046
Pump/All ^b	-	-	-	-	-	-	0.16000	-
Valve/All	99	0.4680 (0.0000)	0.9519 (0.0042)	-4.388	11.30	0.08984	0.14043	0.21952
Other/All ^c	19	0.4759 (0.0000)	0.9140 (0.0900)	-4.853	14.61	0.03374	0.11406	0.38554

^aThe Normal Statistic is generated by default from SAS--by default the Shapiro-Wilk statistic is calculated for sample sizes less than 2,000. Probabilities greater than 0.05 indicate a normal distribution.

^bOnly 2 data points were available for the pump emission factor; therefore the ratio of the pump/overall 10,000 ppmv emission factor was multiplied by the overall 100,000 ppmv emission factor to approximate the pump 100,000 ppmv emission factor

^cThe "other" equipment type was developed from instruments, loading arms, pressure relief valves, stuffing boxes, vents, compressors, and dump lever arms. This "other" equipment type should be applied to any equipment other than connectors, flanges, open-ended lines, pumps, or valves.

APPENDIX C: ATTACHEMENT 3

This attachment lists the bagging data used to develop the default zero emission rates for the combined 1993 petroleum industry data in table C-3-1. Table C-3-2 lists summary statistics for the default zero emission rates.

TABLE C-3-1. BAGGING DATA USED TO DEVELOP DEFAULT ZERO EMISSION RATES

Plant Type	Screening Value (ppmv)	Measured Emission Rate(kg/hr)	Natural Log of Emission Rate (kg/hr)
----- Equipment Type=CONNECTOR SERVICE=G -----			
REF	0.00	0.00000000476	-19.163
REF	0.00	0.00000000636	-18.873
REF	0.00	0.00000002555	-17.483
REF	0.00	0.00000023605	-15.259
REF	0.00	0.00000038635	-14.767
REF	0.00	0.00000362959	-12.526
N = 6			
----- Equipment Type=CONNECTOR SERVICE=LL -----			
REF	0.00	0.00000000501	-19.112
REF	0.00	0.00000000544	-19.030
REF	0.00	0.00000000739	-18.723
REF	0.00	0.00000000763	-18.691
REF	0.00	0.00000000777	-18.673
MT	0.00	0.00000137993	-13.493
MT	0.00	0.00000177942	-13.239
MT	0.00	0.00000258886	-12.864
MT	0.00	0.00000332328	-12.615
REF	0.00	0.00000470743	-12.266
MT	0.00	0.00000863240	-11.660
MT	0.00	0.00001050395	-11.464
N = 12			
----- Equipment Type=FLANGE SERVICE=G -----			
REF	0.00	0.00000000642	-18.863
REF	0.00	0.00000000709	-18.764
REF	0.00	0.00000007912	-16.352
REF	0.00	0.00000080155	-14.037
N = 4			
----- Equipment Type=FLANGE SERVICE=LL -----			
REF	0.00	0.00000000958	-18.464
REF	0.00	0.00000019031	-15.475
REF	0.00	0.00000021919	-15.333
REF	0.00	0.00000021930	-15.333
REF	0.00	0.00000047102	-14.568
N = 5			
----- Equipment Type=LOADARM SERVICE=LL -----			
MT	0.00	0.00005125646	-9.879

TABLE C-3-1. BAGGING DATA USED TO DEVELOP DEFAULT ZERO EMISSION RATES
(CONTINUED)

Plant Type	Screening Value (ppmv)	Measured Emission Rate(kg/hr)	Natural Log of Emission Rate (kg/hr)
N = 1			
----- Equipment Type=OEL SERVICE=G -----			
REF	0.00	0.00000000693	-18.788
REF	0.00	0.00000140955	-13.472
MT	0.00	0.00000303602	-12.705
MT	0.00	0.00000334319	-12.609
N = 4			
----- Equipment Type=OEL SERVICE=HL -----			
REF	0.00	0.00000000575	-18.975
REF	0.00	0.00000000583	-18.960
REF	0.00	0.00000001096	-18.329
REF	0.00	0.00000009800	-16.138
N = 4			
----- Equipment Type=OEL SERVICE=LL -----			
REF	0.00	0.00000000511	-19.093
REF	0.00	0.00000000540	-19.036
REF	0.00	0.00000076594	-14.082
MT	0.00	0.00000288878	-12.755
N = 4			
----- Equipment Type=PRV SERVICE=G -----			
REF	0.00	0.00000000710	-18.763
REF	0.00	0.00000000807	-18.635
REF	0.00	0.00000001125	-18.303
N = 3			
----- Equipment Type=PUMP SERVICE=HL -----			
REF	0.00	0.00000002008	-17.723
REF	0.00	0.00000002256	-17.607
REF	0.00	0.00000002315	-17.581
REF	0.00	0.00000002586	-17.471
REF	0.00	0.00000089186	-13.930
N = 5			

TABLE C-3-1. BAGGING DATA USED TO DEVELOP DEFAULT ZERO EMISSION RATES
(CONTINUED)

Plant Type	Screening Value (ppmv)	Measured Emission Rate(kg/hr)	Natural Log of Emission Rate (kg/hr)
----- Equipment Type=PUMP SERVICE=LL -----			
REF	0.00	0.00000002503	-17.503
REF	0.00	0.00000002714	-17.422
REF	0.00	0.00000005485	-16.719
REF	0.00	0.00000006666	-16.524
REF	0.00	0.00000053647	-14.438
REF	0.00	0.00000186896	-13.190
MT	0.00	0.00000480541	-12.246
MT	0.00	0.00000775832	-11.767
MT	0.00	0.00000998821	-11.514
MT	0.00	0.00001319922	-11.235
MT	0.00	0.00001436632	-11.151
MT	0.00	0.00001653679	-11.010
REF	0.00	0.00002058968	-10.791
MT	0.00	0.00006269164	-9.677
N = 14			
----- Equipment Type=VALVE SERVICE=G -----			
REF	0.00	0.00000000775	-18.676
REF	0.00	0.00000000865	-18.565
REF	0.00	0.00000000940	-18.482
REF	0.00	0.00000000990	-18.431
REF	0.00	0.00000001019	-18.402
REF	0.00	0.00000001420	-18.070
REF	0.00	0.00000002762	-17.405
REF	0.00	0.00000003664	-17.122
REF	0.00	0.00000003966	-17.043
REF	0.00	0.00000004455	-16.927
REF	0.00	0.00000020591	-15.396
REF	0.00	0.00000032682	-14.934
REF	0.00	0.00000032845	-14.929
REF	0.00	0.00000061449	-14.302
REF	0.00	0.00000083416	-13.997
MT	0.00	0.00000125837	-13.586
MT	0.00	0.00000196249	-13.141
MT	0.00	0.00000201696	-13.114
MT	0.00	0.00000208210	-13.082
REF	0.00	0.00000218398	-13.034
MT	0.00	0.00000238633	-12.946
MT	0.00	0.00000798694	-11.738
REF	0.00	0.00000893314	-11.626
REF	0.00	0.00001171097	-11.355
REF	0.00	0.00001563050	-11.066
N = 25			

TABLE C-3-1. BAGGING DATA USED TO DEVELOP DEFAULT ZERO EMISSION RATES
(CONTINUED)

Plant Type	Screening Value (ppmv)	Measured Emission Rate(kg/hr)	Natural Log of Emission Rate (kg/hr)
----- Equipment Type=VALVE SERVICE=HL -----			
REF	0.00	0.00000000660	-18.836
REF	0.00	0.00000000665	-18.828
REF	0.00	0.00000001034	-18.387
REF	0.00	0.00000001058	-18.364
REF	0.00	0.00000001345	-18.124
REF	0.00	0.00000001638	-17.927
REF	0.00	0.00000004990	-16.813
REF	0.00	0.00000005393	-16.736
REF	0.00	0.00000005530	-16.710
REF	0.00	0.00000240865	-12.936
REF	0.00	0.00001479770	-11.121
REF	0.00	0.00002881475	-10.455
REF	0.00	0.00003605008	-10.231
N = 13			
----- Equipment Type=VALVE SERVICE=LL -----			
REF	0.00	0.00000000467	-19.182
REF	0.00	0.00000000637	-18.871
REF	0.00	0.00000000664	-18.830
REF	0.00	0.00000000691	-18.791
REF	0.00	0.00000000834	-18.602
REF	0.00	0.00000000976	-18.445
REF	0.00	0.00000000997	-18.423
REF	0.00	0.00000001104	-18.322
REF	0.00	0.00000001198	-18.240
REF	0.00	0.00000002004	-17.725
REF	0.00	0.00000002139	-17.660
REF	0.00	0.00000002191	-17.636
REF	0.00	0.00000002793	-17.394
REF	0.00	0.00000005696	-16.681
REF	0.00	0.00000007503	-16.405
REF	0.00	0.00000048449	-14.540
REF	0.00	0.00000053602	-14.439
MT	0.00	0.00000103293	-13.783
MT	0.00	0.00000112977	-13.693
REF	0.00	0.00000192842	-13.159
MT	0.00	0.00000195101	-13.147
MT	0.00	0.00000195727	-13.144
MT	0.00	0.00000220253	-13.026
REF	0.00	0.00000233299	-12.968
REF	0.00	0.00000234795	-12.962
REF	0.00	0.00000312302	-12.677
REF	0.00	0.00000683117	-11.894

TABLE C-3-1. BAGGING DATA USED TO DEVELOP DEFAULT ZERO EMISSION RATES
(CONTINUED)

Plant Type	Screening Value (ppmv)	Measured Emission Rate(kg/hr)	Natural Log of Emission Rate (kg/hr)
REF	0.00	0.00000696181	-11.875
REF	0.00	0.00000698812	-11.871
REF	0.00	0.00001664883	-11.003
N = 30			

TABLE C-3-2. DEFAULT ZERO VOC MASS EMISSION RATES AND 95 PERCENT CONFIDENCE INTERVALS DEVELOPED FROM THE COMBINED 1993 REFINERY AND MARKETING TERMINAL DATA^a

Equipment Type/Service	Sample Size	Normal Statistic ^b (Probability of a Larger Normal Statistic)		Mean In Mass Emission Rate	Scale Bias Correction Factor	Lower 95 Percent Confidence Bound for Default Zero Emission Rate (kg/hr)	Default Zero Emission Rate (kg/hr)	Upper 95 Percent Confidence Bound for Default Zero Emission Rate (kg/hr)
		Mass Emission Rate	In Mass Emission Rate					
Connector/All	18	0.7177 (0.0001)	0.8302 (0.0034)	-15.550	42.72	1.64E-06	7.54E-06	3.47E-05
Flange/All	9	0.8137 (0.0296)	0.8687 (0.1173)	-16.354	3.94	7.39E-08	3.11E-07	1.31E-06
Open-Ended Line/All	12	0.7232 (0.0009)	0.7909 (0.0061)	-16.245	22.70	3.19E-07	2.00E-06	1.25E-05
Pump/All	19	0.5942 (0.0000)	0.8532 (0.0065)	-14.184	34.97	5.81E-06	2.42E-05	1.01E-04
Valve/All	68	0.5178 (0.0000)	0.8764 (0.0000)	-15.415	38.38	3.95E-06	7.75E-06	1.52E-05
Other ^c /All	4	0.6297 (0.0000)	0.6691 (0.0045)	-16.395	52.16	3.91E-09	3.95E-06	4.00E-03

^aNo default zero data were collected from oil and gas production facilities

^bThe Normal Statistic is generated by default from SAS--by default the Shapiro-Wilk statistic is calculated for sample sizes less than 2,000. Probabilities greater than 0.05 indicate a normal distribution.

^cThe "other" equipment type were developed from instruments, loading arms, pressure relief valves, stuffing boxes, vents, compressors, and dump lever arms. This "other" equipment type should be applied to any equipment other than connectors, flanges, open-ended lines, pumps, or valves.

APPENDIX C: ATTACHMENT 4

Because it would be impractical to list all of the screening data used to develop emission factors, this attachment summarizes the 1993 marketing terminal and oil and gas production operations screening data sets. Figures C-4-1 through C-4-4 are plots of the distribution of screening values for marketing terminals and figures C-5-5 through C-5-10 are plots of the distribution of screening valves for oil and gas production operations.

Distribution of Screening Values Marketing Terminals – Connectors

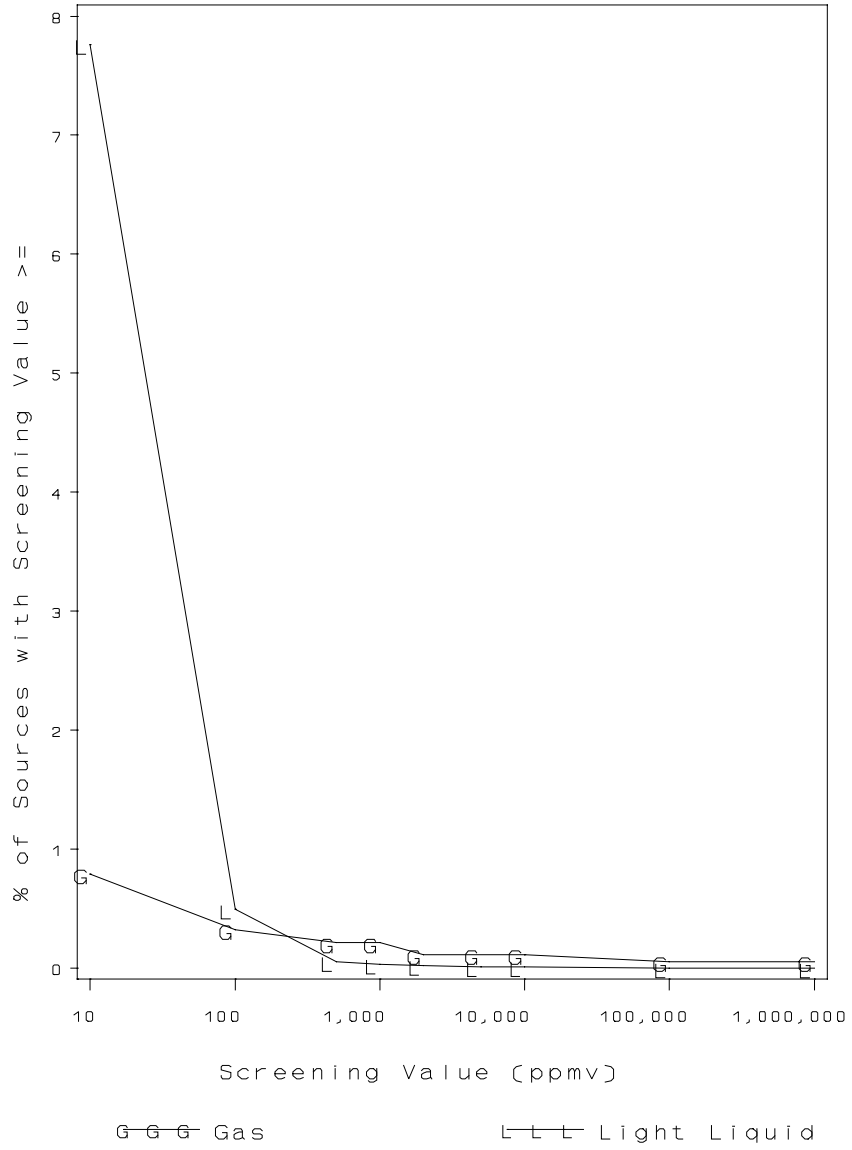

Figure C-4-1. Distribution of Connector Screening Values for Marketing Terminals

Distribution of Screening Values Marketing Terminals – Other

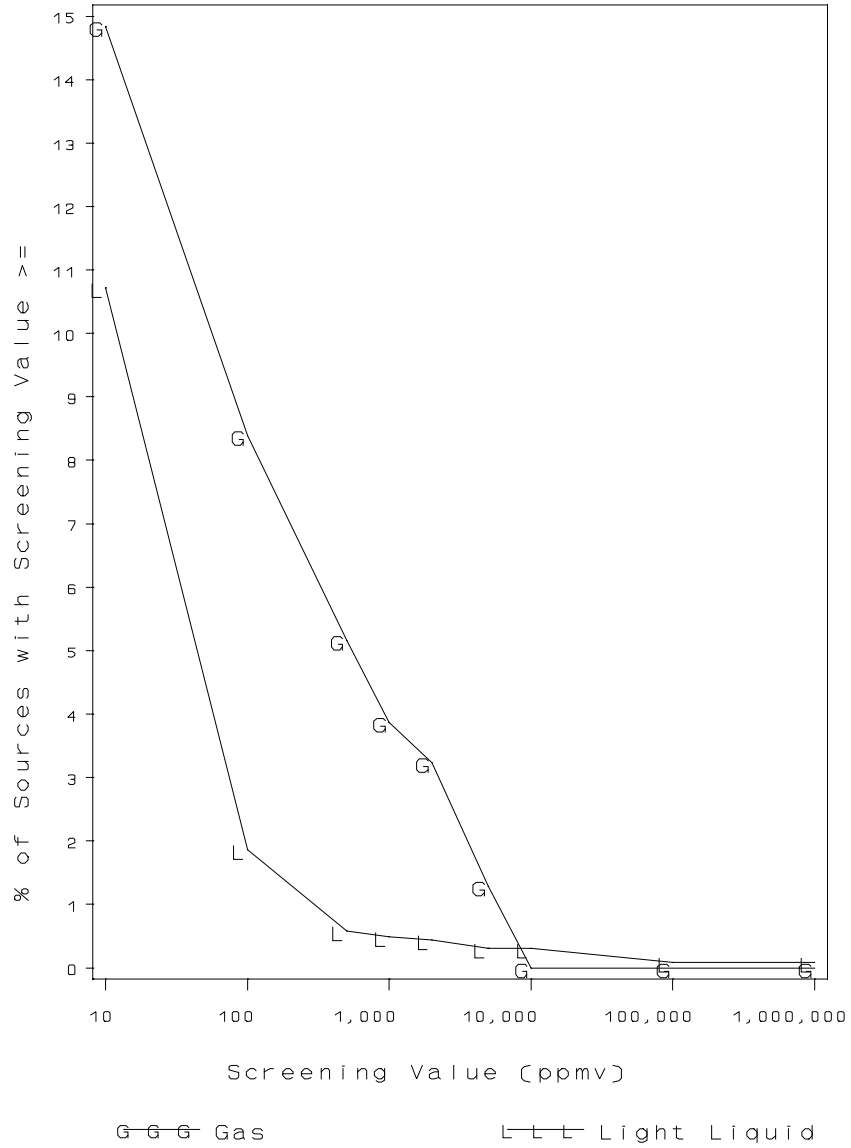

Figure C-4-2. Distribution of Other Screening Values for Marketing Terminals

Distribution of Screening Values

Marketing Terminals – Pumps

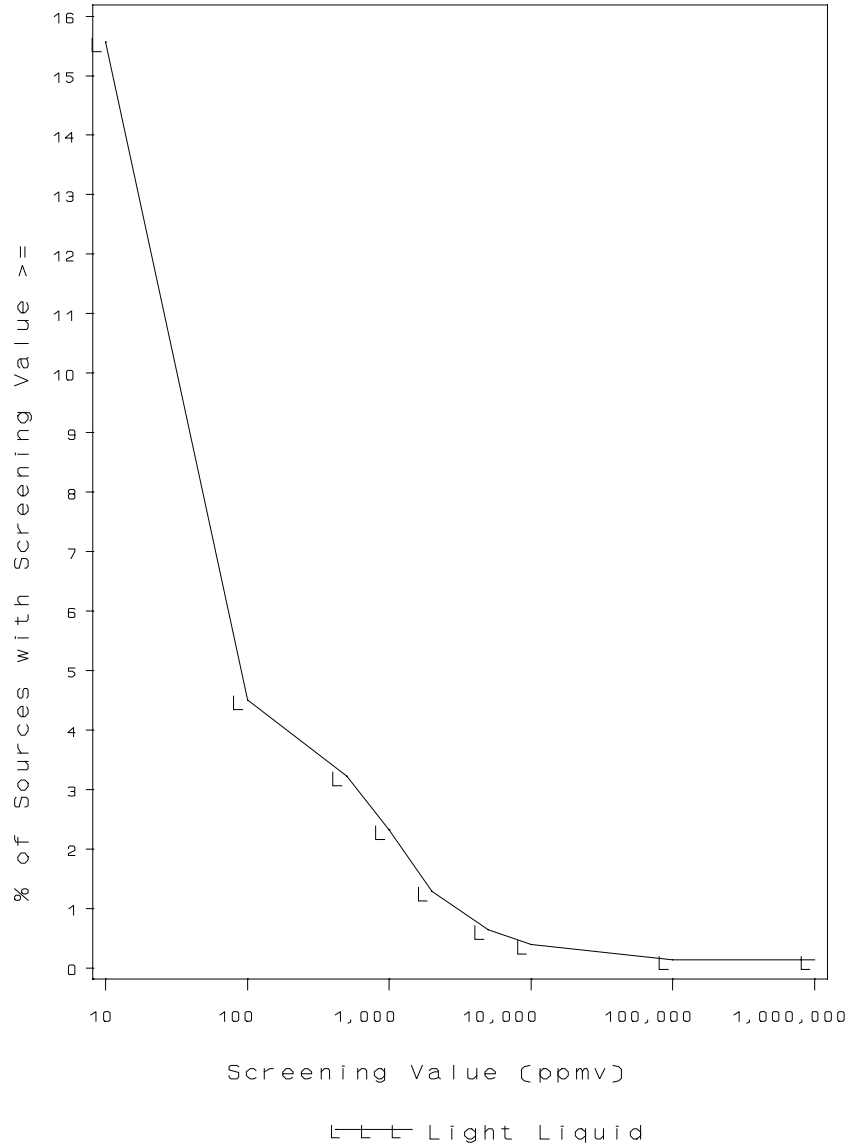

Figure C-4-3. Distribution of Pump Screening Values for Marketing Terminals

Distribution of Screening Values Marketing Terminals – Valves

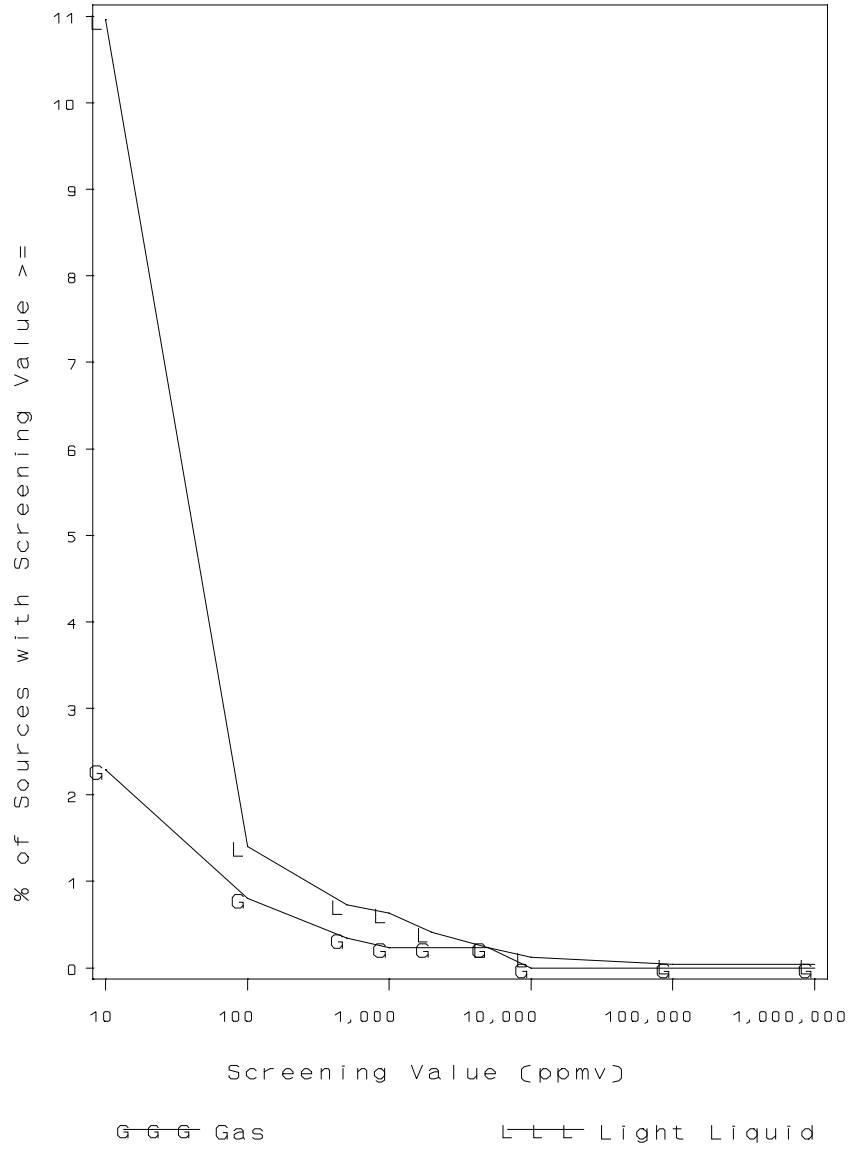

Figure C-4-4. Distribution of Valve Screening Values for Marketing Terminals

Distribution of Screening Values Oil and Gas Operations – Connectors

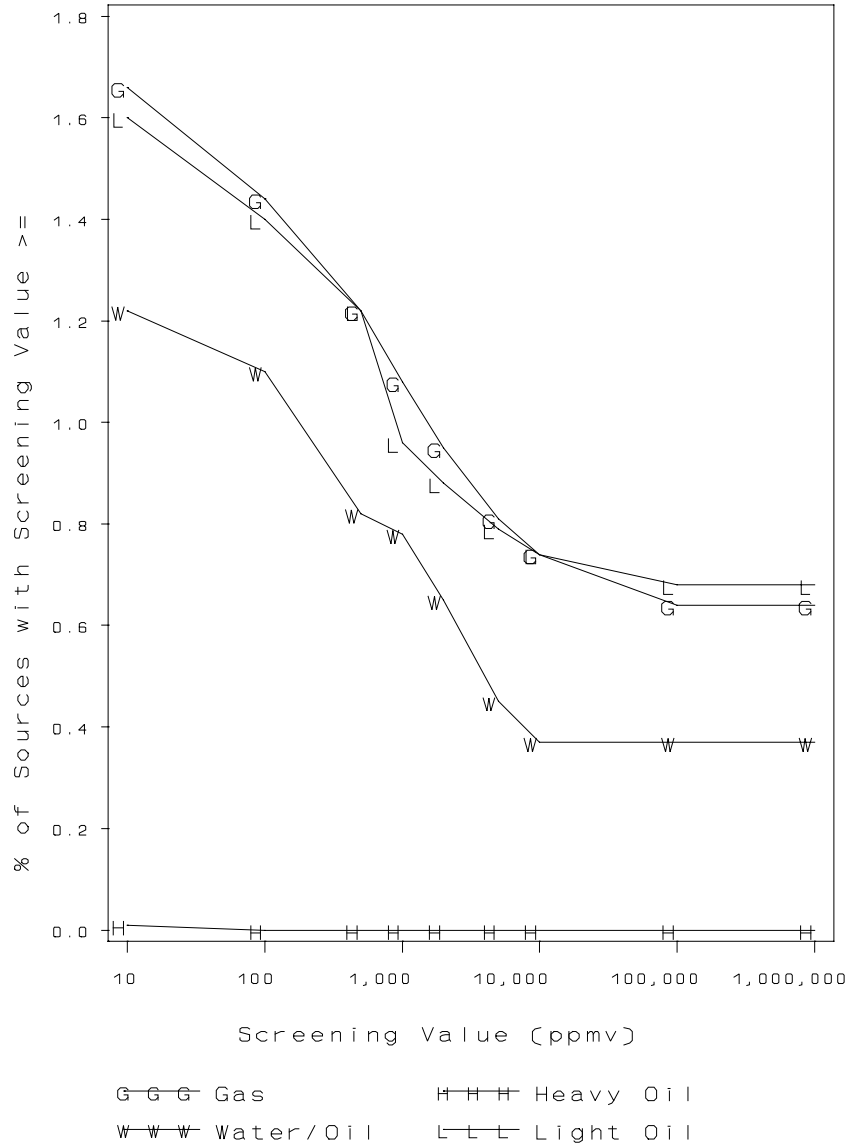

Figure C-4-5. Distribution of Connector Screening Values for Oil and Gas Operations

Distribution of Screening Values Oil and Gas Operations – Flanges

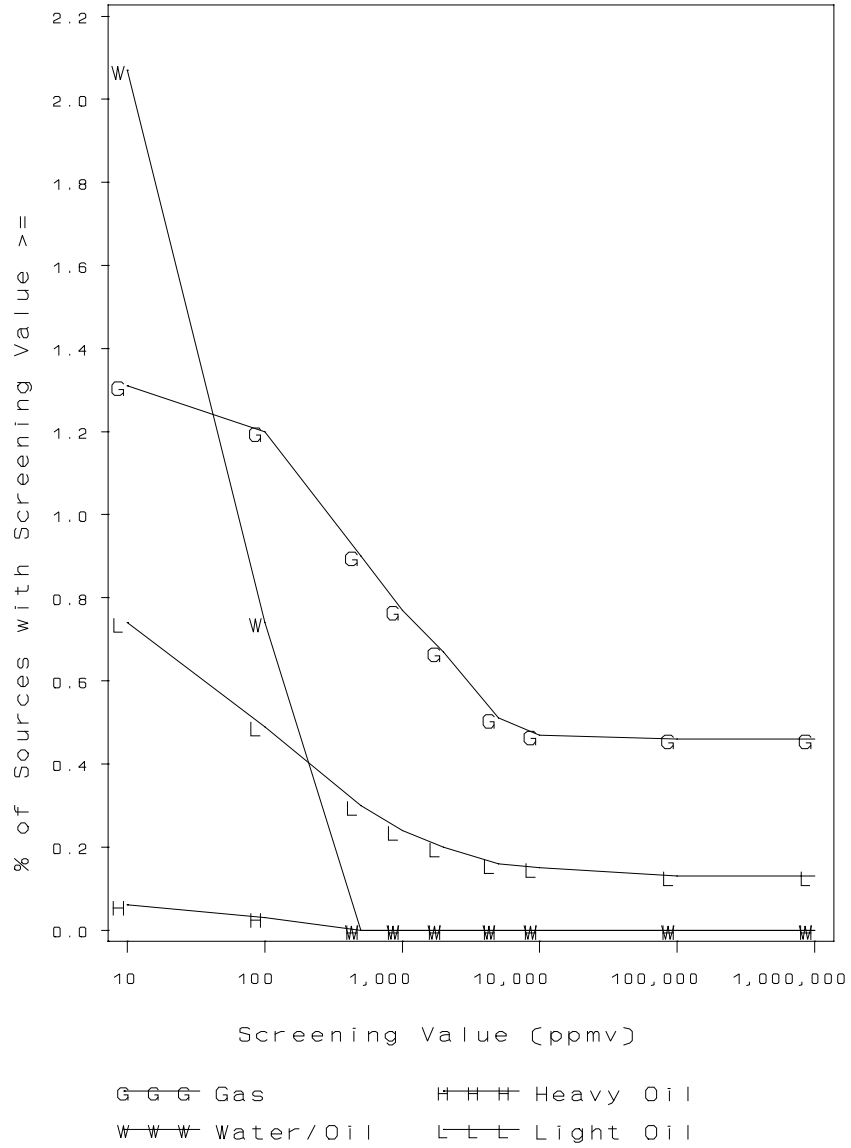

Figure C-4-6. Distribution of Flange Screening Values for Oil and Gas Operations

Distribution of Screening Values Oil and Gas Operations – Open-Ended Lines

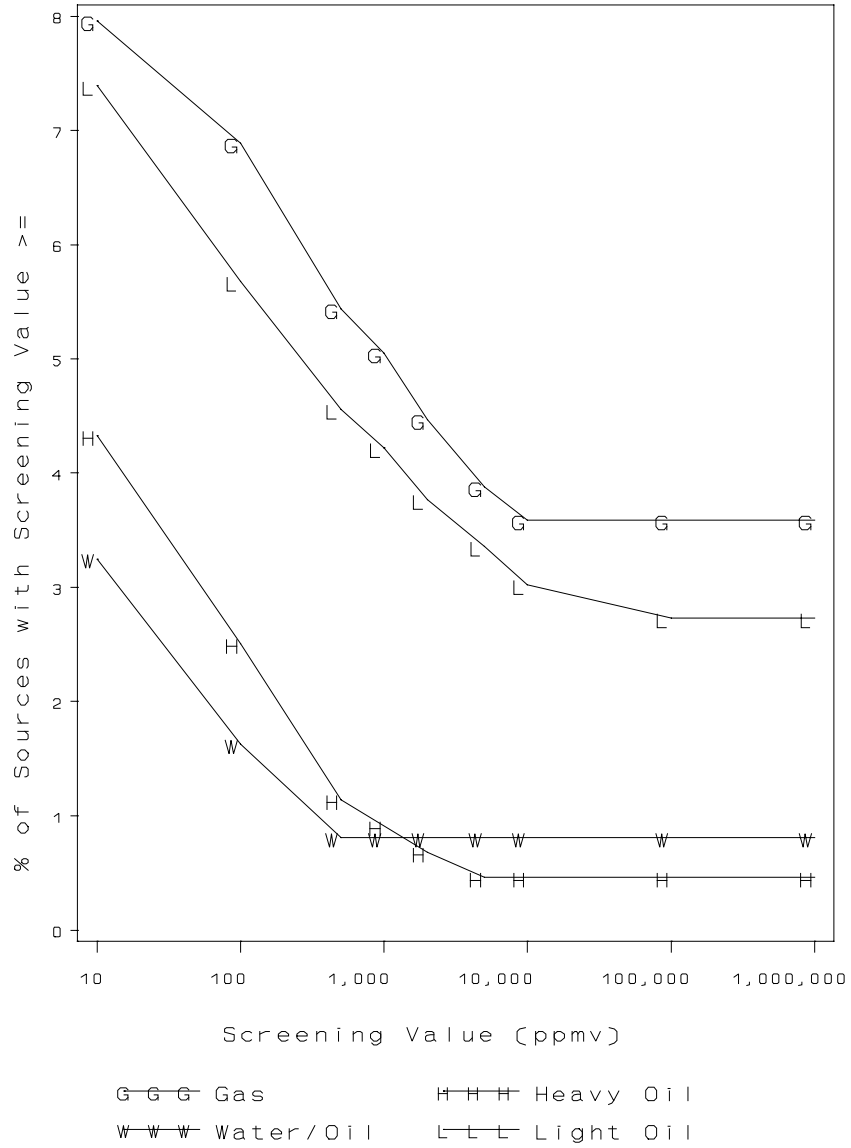

Figure C-4-7. Distribution of Open-Ended Line Screening Values for Oil and Gas Operations

Distribution of Screening Values Oil and Gas Operations – Pumps

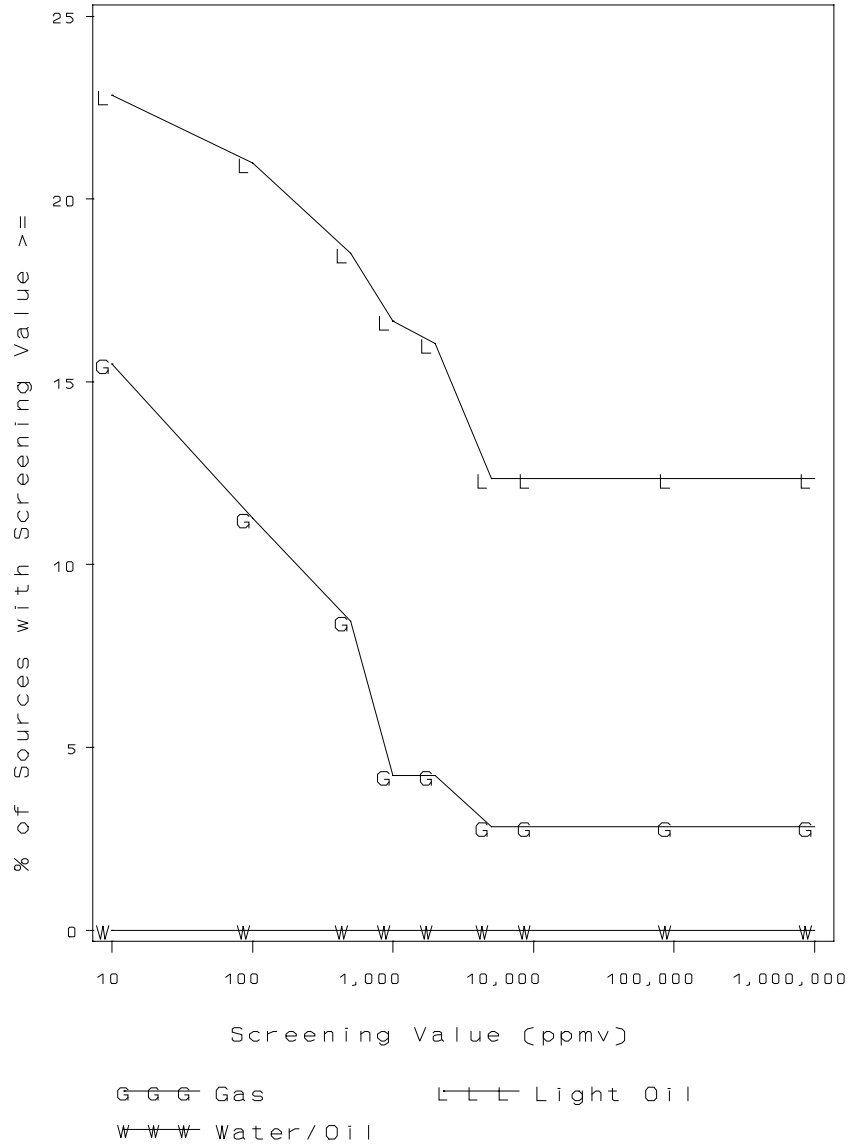

Figure C-4-8. Distribution of Pump Screening Values for Oil and Gas Operations

Distribution of Screening Values Oil and Gas Operations – Valves

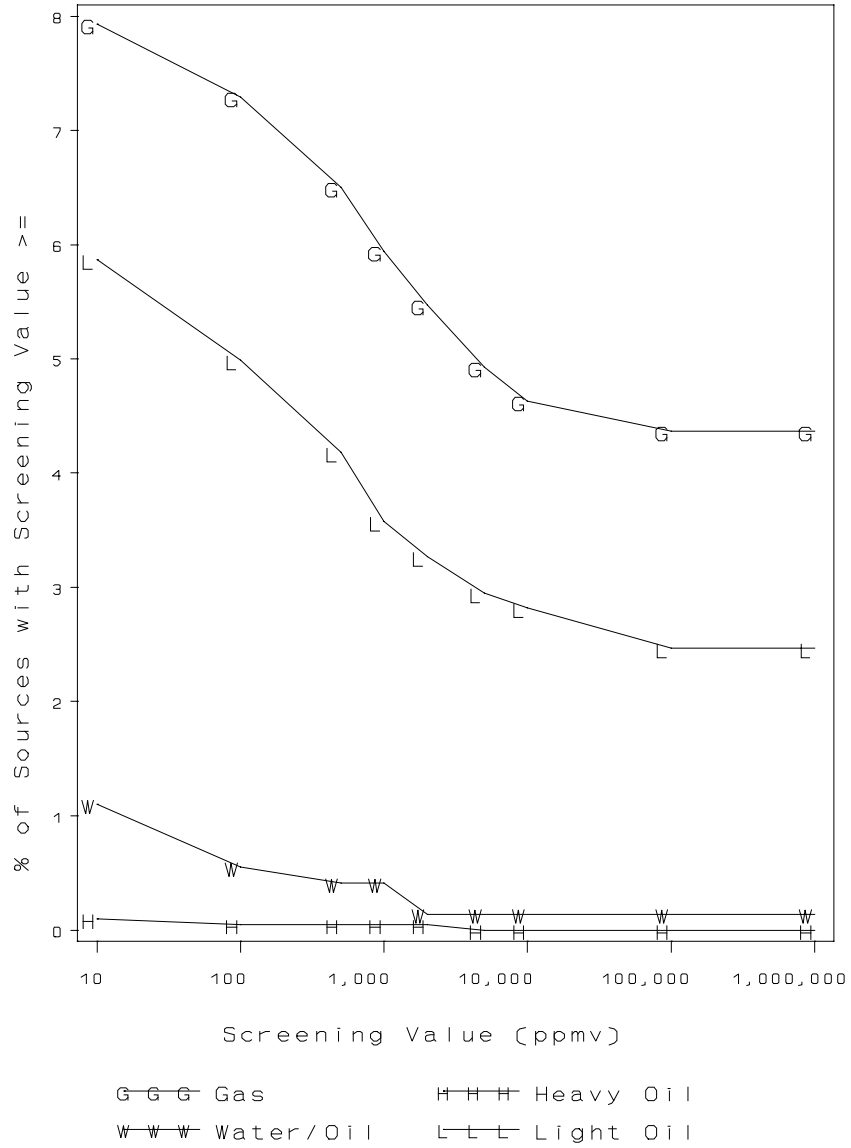

Figure C-4-9. Distribution of Valve Screening Values for Oil and Gas Operations

Distribution of Screening Values Oil and Gas Operations – Other

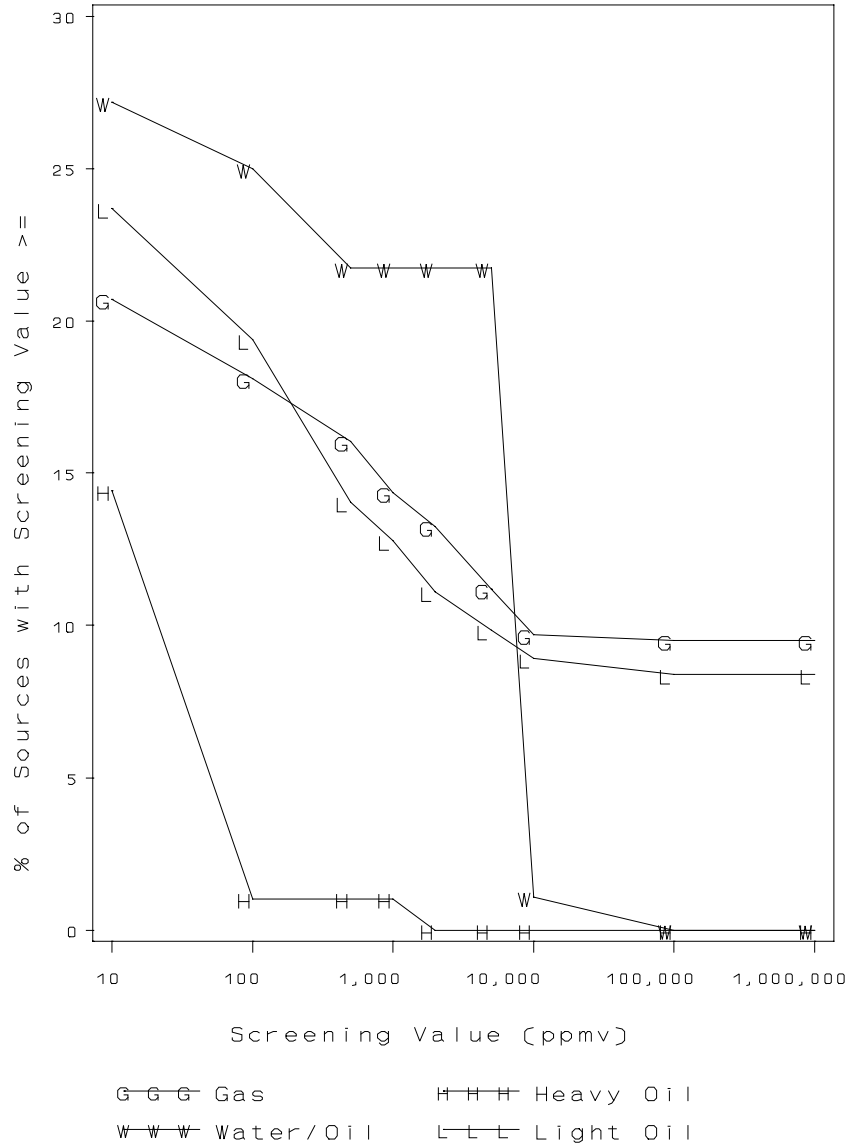

Figure C-4-10. Distribution of Other Screening Values for Oil and Gas Operations

APPENDIX D: RESPONSE FACTORS

APPENDIX D

RESPONSE FACTORS

The response factors presented in table D-1 were taken from two separate sources. The response factors at an actual concentration of 10,000 ppmv are from the EPA document entitled, "Response Factors of VOC Analyzers Calibrated with Methane for Selected Organic Chemicals," EPA-600/2-81-002 (September 1980). The document presents results of analytical tests performed to determine the response factors at 10,000 ppmv of two portable monitoring instruments--the Foxboro OVA-108 and the Bacharach TLV-108. Both instruments were calibrated with methane.

The response factors at a concentration of 500 ppmv are from the document entitled "Method 21 Evaluation for the HON, "90-ME-07)" (March 1991) prepared for the Emission Measurement Branch of the U.S. Environmental Protection Agency. This document presents the results of analytical tests performed to determine the response factors at an actual concentration of 500 ppmv of several emission monitors including the Foxboro OVA-108, two of Foxboro OVA-128 units, the Heath Detecto-PAK III, and the HNU Systems HW-101. The two Foxboro OVA-128 instrument response factors are presented in the table to indicate the variability of individual instruments. To determine the response factor for the OVA-128, the average of the two instrument response factors should be used. All of the instruments except the HNU HW-101 were calibrated with methane. The HNU HW-101 was calibrated with benzene.

A dashed line in table D-1 indicates that the study did not test that particular chemical. If the emission monitor did not respond to a chemical, N/R was recorded to indicate no response.

Operators of portable leak detection devices should be thoroughly familiar with their instrumentation. Even under the best of circumstances, no two analyzers will perform exactly the same and the effect of changes in instrument parameters upon accuracy can be significant. Other external quality controls, such as a checklist for periodically noting battery condition,

fuel pressure, post-survey calibration checks, etc., will support the validity of the data. An audit program testing both the operator and the analyzer should be a requirement whenever a situation warranting an exacting determination of a fugitive emission is encountered.

In general, the response factors follow the pattern which would be predicted for increasing flame ionization detector response with increasing hydrocarbon character for the molecule. The sequence of compounds methyl chloride, methylene chloride, chloroform, and carbon tetrachloride exhibits progressively decreasing response on the OVA detectors (response factors ranging from 2 to 12) as the substitution on the methyl carbon atom increases (i.e., decreasing hydrocarbon character for the molecule). In general, increasing electronegativity of the substituent decreases the system response: methyl chloride, response factor approximately 2; methyl bromide, response factor approximately 5; iodomethane, response factor approximately 8. Carbon tetrachloride exhibits a response factor of 12 or more, but tetrachloroethylene has a response factor of 2 or less. The lack of carbon-hydrogen bonds in tetrachloroethylene is apparently compensated by the presence of a site of unsaturation in the molecule (chlorobenzene, response factor 0.60 vs. trichlorobenzene, response factor of 12 or greater). The difficulty of obtaining a reproducible and useful response factor for compounds of insufficient volatility such as nitrobenzene, m-cresol, and oxygenated compounds such as acrylic acid demonstrates that there is a point dictated by vapor pressure or possibly boiling point where an accurate measurement cannot be made using the portable field analyzers. With compounds which are not very volatile, the portable field analyzers can be used only qualitatively, at best; if a large amount of the compound is present in the air, the compound will be observed but not with a proportionate quantitative response.

TABLE D-1. RESPONSE FACTORS AT ACTUAL CONCENTRATIONS OF 10,000 PPMV AND 500 PPMV

CAS No.#	Compound Name	Volatility Class	Actual Concentration: 10,000 ppmV		Actual Concentration: 500 ppmV				
			Foxboro OVA - 108 ^a	Bacharach TLV ^a	Foxboro OVA - 108 ^a	Foxboro OVA - 128 ^a	Foxboro OVA - 128 ^a	Heath DP III ^a	HNU HW - 101 ^b
75-07-0	Acetaldehyde	LL	--	--	8.41	9.96	7.95	5.36	6.07
64-19-7	Acetic Acid	LL	1.83	5.70	--	--	--	--	--
108-24-7	Acetic anhydride	LL	1.36	2.89	--	--	--	--	--
67-64-1	Acetone	LL	0.79	1.22	--	--	--	--	--
75-86-5	Acetone cyanohydrin	HL	3.42	7.84	--	--	--	--	--
75-05-08	Acetonitrile	LL	0.94	1.17	1.20	1.24	1.27	1.27	N/R
98-86-2	Acetophenone	HL	10.98	54.86	2.71	2.62	2.43	2.92	3.07
75-36-5	Acetyl chloride	LL	1.99	2.59	--	--	--	--	--
74-86-2	Acetylene	G	0.37	11.95	--	--	--	--	--
107-02-8	Acrolein	LL	--	--	6.25	6.69	5.64	3.71	2.73
79-10-7	Acrylic acid	LL	4.65	36.95	10.51 ^C	10.81 ^C	9.63 ^C	8.61 ^C	8.91 ^C
107-13-1	Acrylonitrile	LL	0.96	2.70	1.55	1.58	1.56	1.47	3.04
	Allene	G	0.55	5.78	--	--	--	--	--
107-18-6	Allyl alcohol	LL	0.94		--	--	--	--	--
107-5-1	Allyl chloride	LL	--	--	2.77	2.73	2.51	1.56	1.46
71-41-0c	Amyl alcohol, N-	HL	0.69	1.78	--	--	--	--	--
	Amylene	LL	0.31	1.03	--	--	--	--	--
62-53-3	Aniline	HL	--	--	14.44 ^C	20.45 ^C	22.68 ^C	14.71 ^C	15.23 ^C
100-66-3	Anisole	LL	0.92	2.69	--	--	--	--	--
100-52-7	Benzaldehyde	HL	2.36	6.30	--	--	--	--	--

TABLE D-1. RESPONSE FACTORS AT ACTUAL CONCENTRATIONS OF 10,000 PPMV AND 500 PPMV (Cont.)

CAS No.#	Compound Name	Volatility Class	Actual Concentration: 10,000 ppmV		Actual Concentration: 500 ppmV				
			Foxboro OVA - 108 ^a	Bacharach TLV ^a	Foxboro OVA - 108 ^a	Foxboro OVA - 128 ^a	Foxboro OVA - 128 ^a	Heath DP III ^a	HNU HW - 101 ^b
71-43-2	Benzene	LL	0.21	1.07	0.56	0.54	0.50	0.38	1.00
100-47-0	Benzonitrile	HL	2.24	9.13	--	--	--	--	--
98-88-4	Benzoyl Chloride	HL	6.40	6.60	--	--	--	--	--
100-44-7	Benzyl Chloride	HL	4.20	4.87	1.43	1.42	1.21	0.95	1.34
10-86-0	Bromobenzene	LL	0.36	1.16	--	--	--	--	--
75-25-2	Bromoform	LL	--	--	5.90	6.71	5.68	5.12	0.62
106-99-0	Butadiene, 1,3-	G	0.37	6.00	2.41	2.69	2.37	1.68	2.15
106-97-8	Butane, N-	G	0.38	0.68	--	--	--	--	--
71-36-3	Butanol, N-	LL	1.43	2.80	--	--	--	--	--
78-92-2	Butanol, Sec-	LL	0.70	1.26	--	--	--	--	--
75-65-0	Butanol, Tert-	S	0.44	2.19	--	--	--	--	--
106-98-9	Butene, 1-	G	0.51	2.97	--	--	--	--	--
111-76-2	Butoxyethanol, 2- ^c		--	--	19.37 ^c	26.11 ^c	24.69 ^c	13.93 ^c	9.23 ^c
123-86-4	Butyl acetate	LL	0.60	1.30	--	--	--	--	--
141-32-2	Butyl acrylate, N-	LL	0.64	1.98	--	--	--	--	--
142-96-1	Butyl ether, N-	LL	2.70	2.66	--	--	--	--	--
	Butyl ether, Sec-	LL	0.26	1.13	--	--	--	--	--
109-73-9	Butylamine, N-	LL	0.63	1.91	--	--	--	--	--
13952-84-6	Butylamine, Sec-	LL	0.67	1.50	--	--	--	--	--
75-64-9	Butylamine, Tert-	LL	0.58	1.80	--	--	--	--	--
98-06-6	Butylbenzene, Tert-	HL	1.27	6.42	--	--	--	--	--

D-4

TABLE D-1. RESPONSE FACTORS AT ACTUAL CONCENTRATIONS OF 10,000 PPMV AND 500 PPMV (Cont.)

CAS No.#	Compound Name	Volatility Class	Actual Concentration: 10,000 ppmV		Actual Concentration: 500 ppmV				
			Foxboro OVA - 108 ^a	Bacharach TLV ^a	Foxboro OVA - 108 ^a	Foxboro OVA - 128 ^a	Foxboro OVA - 128 ^a	Heath DP III ^a	HNU HW - 101 ^b
123-72-8	Butyraldehyde, N-	LL	1.39	1.89	--	--	--	--	--
107-92-6	Butyric acid	HL	0.74	4.58	--	--	--	--	--
109-74-0	Butyronitrile	LL	0.46	1.33	--	--	--	--	--
75-1-50	Carbon disulfide	LL	--	2.96	33.87	53.06	N/R	57.06	0.71
56-23-5	Carbon tetrachloride	LL	--	--	12.07	15.99	13.72	11.11	3.06
463-58-1	Carbonyl Sulfide	G	--	--	103.95	N/R	N/R	N/R	3.14
107-20-0	Chloroacetaldehyde	LL	13.40	5.07	--	--	--	--	--
79-04-9	Chloroacetyl chloride	LL	--	--	1.86	1.93	1.66	1.28	3.21
108-90-7	Chlorobenzene	LL	0.36	0.88	0.62	0.60	0.54	0.38	1.06
75-00-3	Chloroethane	G	0.67	2.16	--	--	--	--	--
67-66-3	Chloroform	L	4.48	8.77	2.06	2.38	1.91	1.38	3.35
	Chloromethyl methyl ether		--	--	7.77	9.76	7.52	4.28	1.65
25167-80-0	Chlorophenol, O-	HL	3.33	5.87	--	--	--	--	--
	50% Chloroprene/xylene		--	--	1.46	1.47	1.27	0.77	1.37
	Chloropropene, 1-	LL	0.59	0.86	--	--	--	--	--
	Chloropropene, 3-	LL	0.75	1.24	--	--	--	--	--
108-41-8	Chlorotoluene, M-	LL	0.43	0.92	--	--	--	--	--
95-49-9	Chlorotoluene, O-	LL	0.45	1.05	--	--	--	--	--
106-43-4	Chlorotoluene, P-	LL	0.52	1.15	--	--	--	--	--
95-48-7	Cresol, O-	S	0.95	3.98	--	--	--	--	--

TABLE D-1. RESPONSE FACTORS AT ACTUAL CONCENTRATIONS OF 10,000 PPMV AND 500 PPMV (Cont.)

CAS No.#	Compound Name	Volatility Class	Actual Concentration: 10,000 ppmV		Actual Concentration: 500 ppmV				
			Foxboro OVA - 108 ^a	Bacharach TLV ^a	Foxboro OVA - 108 ^a	Foxboro OVA - 128 ^a	Foxboro OVA - 128 ^a	Heath DP III ^a	HNU HW - 101 ^b
108-39-4	Cresol, M-	LL	--	--	75.60 ^C	115.20 ^C	N/R	N/R	N/R
106-44-5	Cresol, P-	S	--	--	N/R	N/R	N/R	N/R	N/R
4170-30-0	Crotonaldehyde	LL	1.32	8.54	--	--	--	--	--
98-82-8	Cumene	LL	1.92	12.49	2.05	1.82	1.55	0.79	1.87
110-82-7	Cyclohexane	LL	0.36	0.72	--	--	--	--	--
108-93-0	Cyclohexanol	HL	0.82	4.92	--	--	--	--	--
108-94-1	Cyclohexanone	LL	1.50	3.99	--	--	--	--	--
110-83-8	Cyclohexene	LL	0.40	1.84	--	--	--	--	--
108-91-8	Cyclohexylamine	LL	0.47	1.38	--	--	--	--	--
124-18-5	Decane	HL	0.00	0.20	--	--	--	--	--
123-42-2	Diacetone alcohol	HL	1.53	0.98	--	--	--	--	--
431-03-8	Diacetyl	LL	1.61	2.81	--	--	--	--	--
	Dichloro-1-propene, 2,3-	LL	61.51	34.34	--	--	--	--	--
541-73-1	Dichlorobenzene, M-	HL	0.66	1.89	--	--	--	--	--
95-50-1	Dichlorobenzene, O-	HL	0.70	1.22	--	--	--	--	--
75-34-3	Dichloroethane, 1,1-	LL	0.77	1.80	--	--	--	--	--
107-06-2	Dichloroethane, 1,2-	LL	0.95	2.08	--	--	--	--	--
540-59-0	Dichloroethylene, 2-	LL	1.31	1.93	--	--	--	--	--
540-59-0	Dichloroethylene, TRANS, 1,2	LL	1.13	1.86	--	--	--	--	--
111-44-4	Dichloroethyl ether ^C		--	--	22.12 ^C	25.10 ^C	24.48 ^C	16.88 ^C	8.79 ^C

TABLE D-1. RESPONSE FACTORS AT ACTUAL CONCENTRATIONS OF 10,000 PPMV AND 500 PPMV (Cont.)

CAS No.#	Compound Name	Volatility Class	Actual Concentration: 10,000 ppmV		Actual Concentration: 500 ppmV				
			Foxboro OVA - 108 ^a	Bacharach TLV ^a	Foxboro OVA - 108 ^a	Foxboro OVA - 128 ^a	Foxboro OVA - 128 ^a	Heath DP III ^a	HNU HW - 101 ^b
	Dichloromethane	LL	2.26	3.63	--	--	--	--	--
	Dichloropropane, 1,2-	LL	1.03	1.80	--	--	--	--	--
542-75-6	Dichloropropene, 1,3-		--	--	2.03	2.08	1.93	1.23	1.18
25167-70-8	Diisobutylene	LL	0.24	1.39	--	--	--	--	--
	Dimethoxy ethane, 1,2-	LL	1.28	1.43	--	--	--	--	--
68-12-2	Dimethylformamide, N,N-	LL	3.89	2.95	6.42	6.38	7.20	7.09	5.73
57-14-7	Dimethylhydrazine, 1,1-	LL	1.04	2.74	2.68	2.84	3.00	2.89	2.29
67-68-5	Dimethylsulfoxide	HL	0.00	4.88	--	--	--	--	--
123-91-1	Dioxane, 1,4-	LL	1.58	1.23	3.74	4.27	3.60	3.21	1.66
106-89-8	Epichlorohydrin	LL	1.72	2.02	2.30	2.41	2.07	1.27	1.95
106-88-7	Epoxybutane, 1,2-		--	--	2.67	2.54	2.16	1.89	2.68
74-84-0	Ethane	G	0.57	0.73	--	--	--	--	--
64-17-5	Ethanol	LL	2.04	--	--	--	--	--	--
110-80-5	Ethoxy ethanol, 2-	LL	1.68	1.61	3.55	4.09	3.50	2.02	1.70
141078-6	Ethyl acetate	LL	0.84	3.13	--	--	--	--	--
141-97-9	Ethyl acetoacetate	HL	3.02	3.13	--	--	--	--	--
140-88-5	Ethyl acrylate	LL	0.72	--	2.49	2.64	2.18	1.16	1.09
75-00-3	Ethyl chloride	G	--	--	1.68	1.84	1.65	1.10	2.38
105-39-5	Ethyl chloroacetate	LL	1.97	1.47	--	--	--	--	--
60-29-7	Ethyl Ether	LL	0.97	1.11	--	--	--	--	--
100-41-4	Ethylbenzene	LL	0.70	3.14	0.77	0.76	0.66	0.51	1.08

TABLE D-1. RESPONSE FACTORS AT ACTUAL CONCENTRATIONS OF 10,000 PPMV AND 500 PPMV (Cont.)

CAS No.#	Compound Name	Volatility Class	Actual Concentration: 10,000 ppmV		Actual Concentration: 500 ppmV				
			Foxboro OVA - 108 ^a	Bacharach TLV ^a	Foxboro OVA - 108 ^a	Foxboro OVA - 128 ^a	Foxboro OVA - 128 ^a	Heath DP III ^a	HNU HW - 101 ^b
74-85-1	Ethylene	G	0.52	4.49	--	--	--	--	--
106-93-4	Ethylene dibromide		--	--	2.03	2.22	2.03	1.36	0.98
107-06-2	Ethylene dichloride	LL	--	--	1.37	1.59	1.41	1.19	1.42
107-21-1	Ethylene glycol ^c		--	--	24.81	39.39	N/R	33.13	10.91
75-21-8	Ethylene oxide	G	2.72	2.43	2.40	2.77	2.40	1.81	6.61
107-15-3	Ethylenediamine	LL	1.78	2.46	--	--	--	--	--
64-18-6	Formic Acid	LL	34.87	33.21	--	--	--	--	--
	Formalin (37% formaldehyde/H ₂ O)		--	--	18.83	31.39	27.66	16.50	4.04
556-52-5	Glycidol	LL	8.42	5.23	--	--	--	--	--
142-82-5	Heptane	LL	0.30	0.75	--	--	--	--	--
87-68-3	Hexachlorobutadiene ^c		--	--	16.28 ^c	22.99 ^c	18.06 ^c	14.56 ^c	19.34 ^c
100-54-3	Hexane, N-	LL	0.31	0.72	1.42	1.49	1.33	0.93	1.49
592-41-6	Hexene, 1-	LL	0.39	2.92	--	--	--	--	--
	Hydroxyacetone	LL	8.70	9.34	--	--	--	--	--
74-88-4	Iodomethane		--	--	8.06	8.76	7.35	4.59	0.72
75-28-5	Isobutane	G	0.30	0.61	--	--	--	--	--
115-11-7	Isobutylene	G	2.42	6.33	--	--	--	--	--
540-84-1	Isooctane	LL	--	--	1.05	1.05	0.89	0.56	0.98
78-79-5	Isoprene	LL	0.38	--	--	--	--	--	--
78-59-1	Isophorone ^c		--	--	28.80	40.71	N/R	29.69	17.76

TABLE D-1. RESPONSE FACTORS AT ACTUAL CONCENTRATIONS OF 10,000 PPMV AND 500 PPMV (Cont.)

CAS No.#	Compound Name	Volatility Class	Actual Concentration: 10,000 ppmV		Actual Concentration: 500 ppmV				
			Foxboro OVA - 108 ^a	Bacharach TLV ^a	Foxboro OVA - 108 ^a	Foxboro OVA - 128 ^a	Foxboro OVA - 128 ^a	Heath DP III ^a	HNU HW - 101 ^b
67-63-0	Isopropanol	LL	0.90	1.35	--	--	--	--	--
108-21-4	Isopropyl acetate	LL	0.68	1.25	--	--	--	--	--
75-29-6	Isopropyl chloride	LL	0.62	0.99	--	--	--	--	--
590-86-3	Isovaleraldehyde	LL	0.55	2.04	--	--	--	--	--
141-79-7	Mesityl oxide	LL	1.12	3.12	--	--	--	--	--
78-85-3	Methacrolein	LL	1.27	3.10	--	--	--	--	--
79-41-4	Methacrylic acid	HL	0.71	6.61	--	--	--	--	--
67-56-1	Methanol	LL	5.69	1.88	13.24	17.34	N/R	21.73	4.59
111-90-0	Methoxy-ethanol, 2-	LL	2.70	2.19	9.61 ^c	9.87 ^c	N/R	7.91 ^c	2.80 ^c
79-20-9	Methyl acetate	LL	1.80	1.76	--	--	--	--	--
74-99-7	Methyl acetylene	G	0.53	3.92	--	--	--	--	--
74-83-9	Methyl bromide	G	--	--	3.71	3.83	3.46	2.43	1.47
74-87-3	Methyl chloride	G	1.75	2.45	1.97	2.38	1.97	1.27	1.77
78-93-3	Methyl ethyl ketone	LL	0.57	1.12	1.78	1.84	1.59	1.19	2.92
107-31-3	Methyl formate	LL	3.47	1.93	--	--	--	--	--
60-34-4	Methyl hydrazine	LL	--	--	5.47	5.50	5.74	5.44	3.93
108-10-1	Methyl isobutyl ketone	LL	--	--	1.65	1.69	1.40	0.98	1.46
80-62-6	Methyl methacrylate	LL	0.99	2.36	2.02	2.16	1.81	0.92	1.84
	Methyl tert-butyl ketone		--	--	1.23	1.25	1.03	0.72	1.69
108-11-2	Methyl-2-pentanol, 4-	LL	1.70	1.94	--	--	--	--	--

TABLE D-1. RESPONSE FACTORS AT ACTUAL CONCENTRATIONS OF 10,000 PPMV AND 500 PPMV (Cont.)

CAS No.#	Compound Name	Volatility Class	Actual Concentration: 10,000 ppmV		Actual Concentration: 500 ppmV				
			Foxboro OVA - 108 ^a	Bacharach TLV ^a	Foxboro OVA - 108 ^a	Foxboro OVA - 128 ^a	Foxboro OVA - 128 ^a	Heath DP III ^a	HNU HW - 101 ^b
	Methyl-2-pentanone, 4-	LL	0.49	1.54	--	--	--	--	--
	Methyl-3-butyn-2-OL, 2-	LL	0.51	--	--	--	--	--	--
109-87-5	Methylal	LL	1.46	1.41	--	--	--	--	--
100-61-8	Methylaniline, N-	HL	4.13	5.25	--	--	--	--	--
108-87-2	Methylcyclohexane	LL	0.38	0.85	--	--	--	--	--
	Methylcyclohexene, 1-	LL	0.33	2.22	--	--	--	--	--
75-09-2	Methylene chloride	LL	2.26	3.63	1.67	1.72	1.41	0.84	2.06
77-75-8	Methylpentynol	LL	1.17	2.82	--	--	--	--	--
98-83-9	Methylstyrene, A-	LL	10.24	31.46	--	--	--	--	--
110-91-8	Morpholine	LL	0.92	1.93	--	--	--	--	--
98-95-3	Nitrobenzene	HL	29.77	40.61	16.41 ^C	16.52 ^C	N/R	26.01 ^C	19.98 ^C
79-24-3	Nitroethane	LL	1.40	2.54	--	--	--	--	--
75-52-5	Nitromethane	LL	3.32	5.25	--	--	--	--	--
24332-01-4	Nitropropane, 2-	LL	1.06	1.77	1.86	1.91	1.60	1.06	3.29
111-84-2	Nonane-N	LL	1.62	5.54	--	--	--	--	--
111-65-9	Octane	LL	1.04	2.06	--	--	--	--	--
	Phenol (90% carboxylic acid)	LL	--	--	16.38	44.89	47.01	N/R	71.06
109-66-0	Pentane	LL	0.42	0.62	--	--	--	--	--
109-06-8	Picoline, 2-	LL	0.34	1.17	--	--	--	--	--
74-98-6	Propane	G	0.88	0.63	--	--	--	--	--

D-10

TABLE D-1. RESPONSE FACTORS AT ACTUAL CONCENTRATIONS OF 10,000 PPMV AND 500 PPMV (Cont.)

CAS No.#	Compound Name	Volatility Class	Actual Concentration: 10,000 ppmV		Actual Concentration: 500 ppmV				
			Foxboro OVA - 108 ^a	Bacharach TLV ^a	Foxboro OVA - 108 ^a	Foxboro OVA - 128 ^a	Foxboro OVA - 128 ^a	Heath DP III ^a	HNU HW - 101 ^b
123-38-6	Propionaldehyde	LL	1.19	1.65	4.01	4.27	3.95	2.53	4.79
79-09-4	Propionic acid	LL	1.34	3.51	--	--	--	--	--
71-23-8	Propyl alcohol	LL	0.91	1.55	--	--	--	--	--
103-65-1	Propylbenzene, N-	LL	0.44	5.97	--	--	--	--	--
115-07-1	Propylene	G	0.79	2.80	--	--	--	--	--
78-87-5	Propylene dichloride	LL	--	--	1.49	1.48	1.26	0.84	1.37
75-56-0	Propylene oxide	LL	0.80	1.15	2.02	2.14	1.78	1.26	3.09
75-55-8	Propyleneimine, 1,2-		--	--	1.75	1.52	1.53	1.33	2.31
110-86-1	Pyridine	LL	0.41	1.17	--	--	--	--	--
100-42-5	Styrene	LL	4.16	36.83	1.10	1.08	0.93	0.57	1.36
96-09-3	Styrene Oxide	L	--	--	2.61	2.49	2.06	2.61	3.03
79-34-5C	Tetrachloroethane, 1,1,1,2-	LL	3.00	6.52	--	--	--	--	--
	Tetrachloroethane, 1,1,2,2-	LL	6.06	14.14	1.64	1.69	1.66	1.14	1.52
127-18-4	Tetrachloroethylene	LL	3.16	11.46	1.77	2.09	1.72	1.20	0.74
108-88-3	Toluene	LL	0.33	2.32	0.87	0.87	0.76	0.57	1.25
120-82-1	Trichlorobenzene, 1,2,4		1.35	0.39	12.55	16.71	N/R	18.66	16.58
71-55-6	Trichloroethane, 1,1,1-	LL	0.79	2.41	1.09	1.16	1.03	0.70	1.85
79-00-5	Trichloroethane, 1,1,2-	LL	1.26	3.68	1.19	1.27	1.11	0.79	1.33
79-01-6	Trichloroethylene	LL	0.94	3.35	2.26	2.60	2.14	1.25	1.09
96-18-4	Trichloropropane, 1,2,3-	LL	0.95	2.23	--	--	--	--	--

D-11

TABLE D-1. RESPONSE FACTORS AT ACTUAL CONCENTRATIONS OF 10,000 PPMV AND 500 PPMV (Cont.)

CAS No.#	Compound Name	Volatility Class	Actual Concentration: 10,000 ppmV		Actual Concentration: 500 ppmV				
			Foxboro OVA - 108 ^a	Bacharach TLV ^a	Foxboro OVA - 108 ^a	Foxboro OVA - 128 ^a	Foxboro OVA - 128 ^a	Heath DP III ^a	HNU HW - 101 ^b
121-44-8	Triethylamine	LL	0.46	1.41	0.47	0.49	0.48	0.35	0.73
108-05-4	Vinyl acetate	LL	1.31	3.99	3.63	3.36	2.80	1.48	2.07
593-60-2	Vinyl bromide	G	--	--	2.14	2.41	2.33	1.68	1.37
75-01-4	Vinyl chloride	G	0.65	1.10	2.03	2.11	2.11	1.76	2.18
	Vinyl propionate	LL	0.94	0.70	--	--	--	--	--
75-35-4	Vinylidene chloride	LL	1.15	2.38	2.73	2.97	2.61	1.79	1.70
106-42-3	Xylene, P-	LL	2.27	5.35	0.89	0.88	0.74	0.54	0.93
108-38-3	Xylene, M-	LL	0.30	3.56	0.89	0.89	0.75	0.54	0.96
95-47-6	Xylene, O-	LL	0.36	1.40	0.95	0.95	0.80	0.60	1.09

N/R = No response

^a = Calibrated with methane in air.

^b = Calibrated with benzene in air.

^c = Volatility problem with compound.

APPENDIX E

SELECTION OF SAMPLE SIZE FOR SCREENING CONNECTORS

APPENDIX E

SELECTION OF SAMPLE SIZE FOR SCREENING CONNECTORS

In estimating emissions for a given process unit, all equipment components must be surveyed for each class of components. The one exception to this "total component screening" criterion is the category of connectors. Note however, that if the process unit is subject to a standard which requires the screening of connectors, then all connectors must be screened. In typical process units, connectors represent the largest count of individual equipment components, making it costly to screen all components. The purpose of this appendix is to present a methodology for determining how many connectors must be screened to constitute a large enough sample size to identify the actual screening value distribution of connectors in the entire process unit. Please note that the sampling is to be a random sampling throughout the process unit.

The basis for selecting the sample population to be screened is the probability that at least one "leaking" connector will be in the screened population. The "leaker" is used as a representation of the complete distribution of screening values for the entire class of sources. The following binomial distribution was developed to approximate the number of connectors that must be screened to ensure that the entire distribution of screening values for these components is represented in the sample:

$$n \geq N \times \{1 - (1 - p)^{1/D}\} \quad (E-1)$$

where:

N = Number of connectors;

D = (fraction of leaking connectors) \times N; and

p \geq 0.95.

Refer to figure E-1, which shows the fraction of leaking connectors at several leak definitions based on currently available data. Since the fraction of leaking connectors will most likely not be known prior to screening, the leaking fraction at the intersection of the SOCFI average emission factor line and applicable leak definition line on figure F-1 can be used to estimate what the fraction of leaking connectors will be. Entering this value into equation E-1 for at least a 95 percent confidence interval ($p = 0.95$) will give the minimum number of connectors that need to be screened. A larger sample size will be required for units exhibiting a lower fraction of leaking connectors.

After 'n' connectors have been screened, an actual leak frequency should be calculated as follows:

$$\text{Leaking frequency} = \frac{\text{Number of leaking connectors}}{n} \quad (\text{E-2})$$

Then, the confidence level of the sample size can be calculated using the following equation, based upon a hypergeometric distribution:

$$p = 1 - \frac{(N-D')! (N-n)!}{N! (N-D'-n)!} \quad (\text{E-3})$$

where:

- N = Total population of connectors;
- n = Sample size; and
- D' = $\frac{\text{Number of leaking connectors}}{n} \times N$

If 'p' calculated in this manner is less than 0.95, then a less than 95 percent confidence exists that the screening value distribution has been properly identified. Therefore, additional connectors must be screened to achieve a 95 percent confidence level. The number of additional connectors required to satisfy the requirement for a 95 percent confidence level can be calculated by solving Equation (E-1) again, using the leak frequency calculated in Equation (E-2), and subtracting the

SOCMI Connector Equations

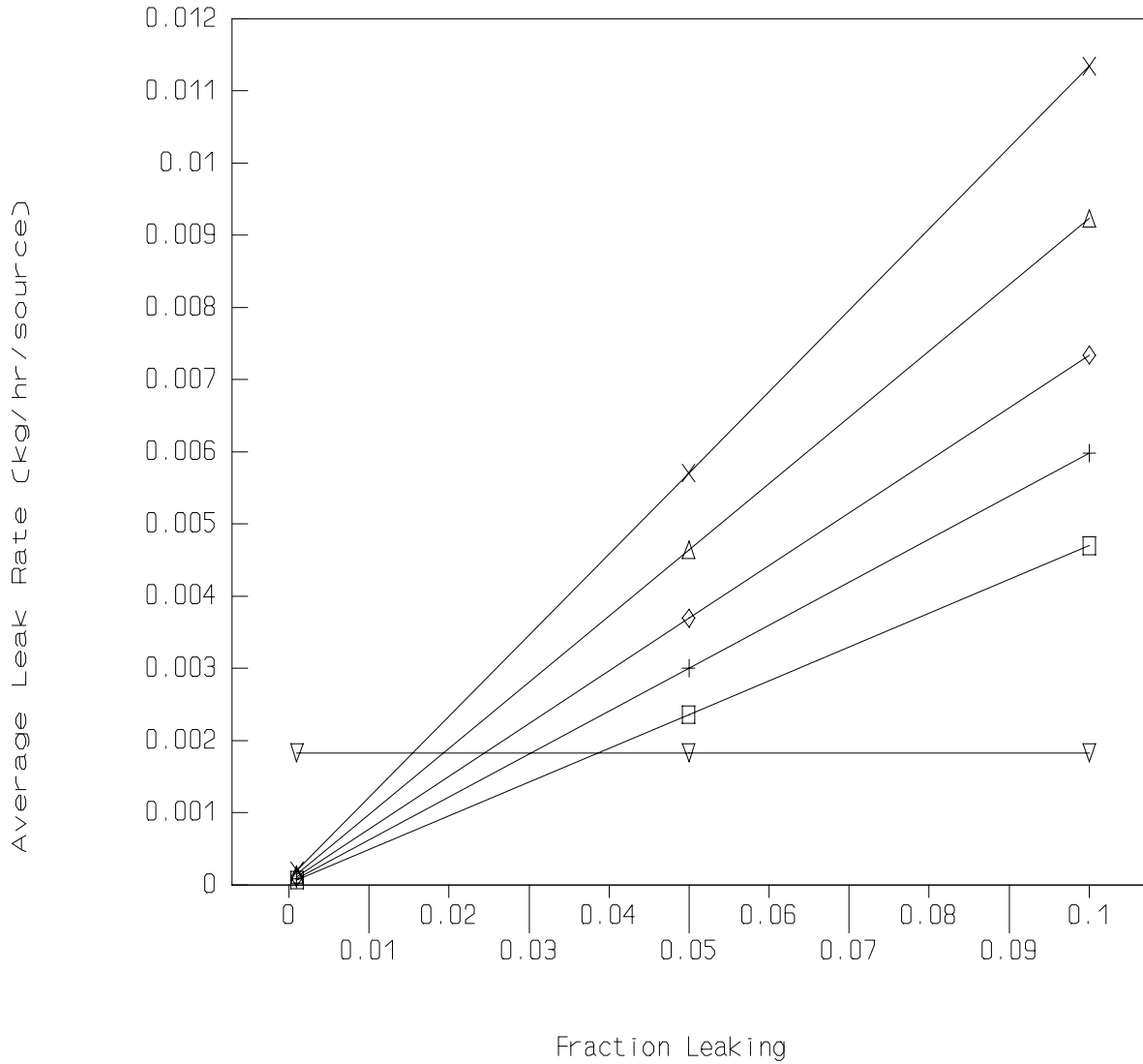

□ 500 ppmv Lk. Def. + 1,000 ppmv Lk. Def. ◇ 2,000 ppmv Lk. Def.

Figure E-1. Fraction of Leaking Connectors at Several Leak Definitions

original sample size. After this additional number of connectors have been screened, the revised fraction of leaking components and the confidence level of the new sample size (i.e., the original sample size plus the additional connectors screened) should be recalculated using Equation (E-3). The Agency requires sufficient screening to achieve a 95 percent confidence level, until a maximum of 50 percent of the total number of connectors in the process unit have been screened. The EPA believes that 50 percent of the total connector population is a reasonable upper limit for a sample size. If half of the total number of connectors are screened, no further connector screening is necessary, even if a 95 percent confidence level has not been achieved.

APPENDIX F

REFERENCE METHOD 21

(Code of Federal Regulations, Title 40, Part 60, Appendix A. Reference Method 21, Determination of Volatile Organic Compound Leaks. Washington, D.C., U.S. Government Printing Office. Revised June 22, 1990.)

**EMISSION MEASUREMENT TECHNICAL INFORMATION CENTER
NSPS TEST METHOD**

(EMTIC M-21, 2/9/93)

Method 21 - Determination of Volatile Organic Compound Leaks

1. APPLICABILITY AND PRINCIPLE

1.1 Applicability. This method applies to the determination of volatile organic compound (VOC) leaks from process equipment. These sources include, but are not limited to, valves, flanges and other connections, pumps and compressors, pressure relief devices, process drains, open-ended valves, pump and compressor seal system degassing vents, accumulator vessel vents, agitator seals, and access door seals.

1.2 Principle. A portable instrument is used to detect VOC leaks from individual sources. The instrument detector type is not specified, but it must meet the specifications and performance criteria contained in section 3. A leak definition concentration based on a reference compound is specified in each applicable regulation. This procedure is intended to locate and classify leaks only, and is not to be used as a direct measure of mass emission rate from individual sources.

2. DEFINITIONS

2.1 Leak Definition Concentration. The local VOC concentration at the surface of a leak source that indicates that a VOC emission (leak) is present. The leak definition is an instrument meter reading based on a reference compound.

2.2 Reference Compound. The VOC species selected as an instrument calibration basis for specification of the leak definition concentration. (For example, if a leak definition concentration is 10,000 ppm as methane, then any source emission that results in a local concentration that yields a meter reading of 10,000 on an instrument meter calibrated with methane would be classified as a leak. In this example, the leak definition is 10,000 ppm, and the reference compound is methane.)

2.3 Calibration Gas. The VOC compound used to adjust the instrument meter reading to a known value. The calibration gas is usually the reference compound at a known concentration approximately equal to the leak definition concentration.

2.4 No Detectable Emission. The total VOC concentration at the surface of a leak source that indicates that a VOC emission (leak) is not present. Since background VOC concentrations may exist, and to account for instrument drift and imperfect reproducibility, a difference between the source surface

concentration and the local ambient concentration is determined. A difference based on the meter readings of less than a concentration corresponding to the minimum readability specification indicates that a VOC emission (leak) is not present. (For example, if the leak definition in a regulation is 10,000 ppm, then the allowable increase in surface concentration versus local ambient concentration would be 500 ppm based on the instrument meter readings.)

2.5 Response Factor. The ratio of the known concentration of a VOC compound to the observed meter reading when measured using an instrument calibrated with the reference compound specified in the applicable regulation.

2.6 Calibration Precision. The degree of agreement between measurements of the same known value, expressed as the relative percentage of the average difference between the meter readings and the known concentration to the known concentration.

2.7 Response Time. The time interval from a step change in VOC concentration at the input of the sampling system to the time at which 90 percent of the corresponding final value is reached as displayed on the instrument readout meter.

3. APPARATUS

3.1 Monitoring Instrument.

3.1.1 Specifications

a. The VOC instrument detector shall respond to the compounds being processed. Detector types which may meet this requirement include, but are not limited to, catalytic oxidation, flame ionization, infrared absorption, and photoionization.

b. The instrument shall be capable of measuring the leak definition concentration specified in the regulation.

c. The scale of the instrument meter shall be readable to + or - 5 percent of the specified leak definition concentration.

d. The instrument shall be equipped with a pump so that a continuous sample is provided to the detector. The nominal sample flow rate shall be 0.1 to 3.0 liters per minute.

e. The instrument shall be intrinsically safe for operation in explosive atmospheres as defined by the applicable U.S.A. standards (e.g., National Electrical Code by the National Fire Prevention Association).

f. The instrument shall be equipped with a probe or probe extension for sampling not to exceed 1/4 in. in outside diameter, with a single end opening for admission of sample.

3.1.2 Performance Criteria.

- a.** The instrument response factors for the individual compounds to be measured must be less than 10.
- b.** The instrument response time must be equal to or less than 30 seconds. The response time must be determined for the instrument configuration to be used during testing.
- c.** The calibration precision must be equal to or less than 10 percent of the calibration gas value.
- d.** The evaluation procedure for each parameter is given in section 4.4.

3.1.3 Performance Evaluation Requirements.

- a.** A response factor must be determined for each compound that is to be measured, either by testing or from reference sources. The response factor tests are required before placing the analyzer into service, but do not have to be repeated at subsequent intervals.
- b.** The calibration precision test must be completed prior to placing the analyzer into service, and at subsequent 3-month intervals or at the next use whichever is later.
- c.** The response time test is required before placing the instrument into service. If a modification to the sample pumping system or flow configuration is made that would change the response time, a new test is required before further use.

3.2 Calibration Gases.

The monitoring instrument is calibrated in terms of parts per million by volume (ppm) of the reference compound specified in the applicable regulation. The calibration gases required for monitoring and instrument performance evaluation are a zero gas (air, less than 10 ppm VOC) and a calibration gas in air mixture approximately equal to the leak definition specified in the regulation. If cylinder calibration gas mixtures are used, they must be analyzed and certified by the manufacturer to be within + or - 2 percent accuracy, and a shelf life must be specified. Cylinder standards must be either reanalyzed or replaced at the end of the specified shelf life. Alternatively, calibration gases may be prepared by the user according to any accepted gaseous preparation procedure that will yield a mixture accurate to within + or - 2 percent. Prepared standards must be replaced each day of use unless it can be demonstrated that degradation does not occur during storage.

Calibrations may be performed using a compound other than the reference compound if a conversion factor is determined for that alternative compound so that the resulting meter readings

during source surveys can be converted to reference compound results.

4. PROCEDURES

4.1 Pretest Preparations. Perform the instrument evaluation procedure given in section 4.4 if the evaluation requirement of section 3.1.3 have not been met.

4.2 Calibration Procedures. Assemble and start up the VOC analyzer according to the manufacturer's instructions. After the appropriate warmup period and zero internal calibration procedure, introduce the calibration gas into the instrument sample probe. Adjust the instrument meter readout to correspond to the calibration gas value. (Note: If the meter readout cannot be adjusted to the proper value, a malfunction of the analyzer is indicated and corrective actions are necessary before use.)

4.3 Individual Source Surveys.

4.3.1 Type I - Leak Definition Based on Concentration. Place the probe inlet at the surface of the component interface where leakage could occur. Move the probe along the interface periphery while observing the instrument readout. If an increased meter reading is observed, slowly sample the interface where leakage is indicated until the maximum meter reading is obtained. Leave the probe inlet at this maximum reading location for approximately two times the instrument response time. If the maximum observed meter reading is greater than the leak definition in the applicable regulation, record and report the results as specified in the regulation reporting requirements. Examples of the application of this general technique to specific equipment types are:

a. Valves - Leaks usually occur at the seal between the stem and the housing. Place the probe at the interface where the stem exits the packing and sample the stem circumference and the flange periphery. Survey valves of multipart assemblies where a leak could occur.

b. Flanges and Other Connections - Place the probe at the outer edge of the flange-gasket interface and sample the circumference of the flange.

c. Pump or Compressor Seals - If applicable, determine the type of shaft seal. Perform a survey of the local area ambient VOC concentration and determine if detectable emissions exist as described above.

d. Pressure Relief Devices - For those devices equipped with an enclosed extension, or horn, place the probe inlet at approximately the center of the exhaust area to the atmosphere.

e. Process Drains - For open drains, place the probe inlet as near as possible to the center of the area open to the atmosphere. For covered drains, locate probe at the surface of the cover and traverse the periphery.

f. Open-ended Lines or Valves - Place the probe inlet at approximately the center of the opening of the atmosphere.

g. Seal System Degassing Vents, Accumulator Vessel Vents, Pressure Relief Devices - If applicable, observe whether the applicable ducting or piping exists. Also, determine if any sources exist in the ducting or piping where emissions could occur before the control device. If the required ducting or piping exists and there are no sources where the emissions could be vented to the atmosphere before the control device, then it is presumed that no detectable emissions are present. If there are sources in the ducting or piping where emissions could be vented or sources where leaks could occur, the sampling surveys described in this section shall be used to determine if detectable emissions exist.

h. Access door seals - Place the probe inlet at the surface of the door seal interface and traverse the periphery.

4.3.2 Type II - "No Detectable Emission". Determine the ambient concentration around the source by moving the probe randomly upwind and downwind around one to two meters from the source. In case of interferences, this determination may be made closer to the source down to no closer than 25 centimeters. Then move the probe to the surface of the source and measure as in 4.3.1. The difference in these concentrations determines whether there are no detectable emissions. When the regulation also requires that no detectable emissions exist, visual observations and sampling surveys are required. Examples of this technique are: (a) Pump or Compressor Seals - Survey the local area ambient VOC concentration and determine if detectable emissions exist. (b) Seal System Degassing Vents, Accumulator Vessel Vents, Pressure Relief Devices - Determine if any VOC sources exist upstream of the device. If such ducting exists and emissions cannot be vented to the atmosphere upstream of the control device, then it is presumed that no detectable emissions are present. If venting is possible sample to determine if detectable emissions are present.

4.3.3 Alternative Screening Procedure.

4.3.3.1 A screening procedure based on the formation of bubbles in a soap solution that is sprayed on a potential leak source may be used for those sources that do not have continuously moving parts, that do not have surface temperatures greater than the boiling point or less than the freezing point of the soap solution, that do not have open areas to the atmosphere that the soap solution cannot bridge, or that do not exhibit evidence of

liquid leakage. Sources that have these conditions present must be surveyed using the instrument technique of section 4.3.1 or 4.3.2.

4.3.3.2 Spray a soap solution over all potential leak sources. The soap Solution may be a commercially available leak detection solution or may be prepared using concentrated detergent and water.

A pressure sprayer or squeeze bottle may be used to dispense the solution. Observe the potential leak sites to determine if any bubbles are formed. If no bubbles are observed, the source is presumed to have no detectable emissions or leaks as applicable. If any bubbles are observed, the instrument techniques of section 4.3.1 or 4.3.2 shall be used to determine if a leak exists, or if the source has detectable emissions, as applicable.

4.4 Instrument Evaluation Procedures. At the beginning of the instrument performance evaluation test, assemble and start up the instrument according to the manufacturer's instructions for recommended warmup period and preliminary adjustments.

4.4.1 Response Factor.

4.4.1.1 Calibrate the instrument with the reference compound as specified in the applicable regulation. For each organic species that is to be measured during individual source surveys, obtain or prepare a known standard in air at a concentration of approximately 80 percent of the applicable leak definition unless limited by volatility or explosivity. In these cases, prepare a standard at 90 percent of the standard saturation concentration, or 70 percent of the lower explosive limit, respectively. Introduce this mixture to the analyzer and record the observed meter reading. Introduce zero air until a stable reading is obtained. Make a total of three measurements by alternating between the known mixture and zero air. Calculate the response factor for each repetition and the average response factor.

4.4.1.2 Alternatively, if response factors have been published for the compounds of interest for the instrument or detector type, the response factor determination is not required, and existing results may be referenced. Examples of published response factors for flame ionization and catalytic oxidation detectors are included in the Bibliography.

4.4.2 Calibration Precision. Make a total of three measurements by alternately using zero gas and the specified calibration gas. Record the meter readings. Calculate the average algebraic difference between the meter readings and the known value. Divide this average difference by the known calibration value and multiply by 100 to express the resulting calibration precision as a percentage.

4.4.3 Response Time. Introduce zero gas into the instrument sample probe. When the meter reading has stabilized, switch quickly to the specified calibration gas. Measure the time from switching to when 90 percent of the final stable reading is attained. Perform this test sequence three times and record the results. Calculate the average response time.

5. BIBLIOGRAPHY

- 1.** Dubose, D.A., and G.E. Harris. Response Factors of VOC Analyzers at a Meter Reading of 10,000 ppmv for Selected Organic Compounds. U.S. Environmental Protection Agency, Research Triangle Park, NC. Publication No. EPA 600/2-81051. September 1981.
- 2.** Brown, G.E., et al. Response Factors of VOC Analyzers Calibrated with Methane for Selected Organic Compounds. U.S. Environmental Protection Agency, Research Triangle Park, NC. Publication No. EPA 600/2-81-022. May 1981.
- 3.** DuBose, D.A. et al. Response of Portable VOC Analyzers to Chemical Mixtures. U.S. Environmental Protection Agency, Research Triangle Park, NC. Publication No. EPA 600/2-81-110. September 1981.

APPENDIX G

DEVELOPMENT OF LEAK RATE
VERSUS FRACTION LEAKING EQUATIONS
AND DETERMINATION OF LDAR CONTROL EFFECTIVENESS

APPENDIX G

The purpose of this appendix is to provide additional information on the approach used to develop the average leak rate versus fraction leaking equations presented in chapter 5.0. Also, background information is presented on the determination of control effectiveness of LDAR programs at SOCFI process units and refinery process units.

G.1 DEVELOPMENT OF AVERAGE LEAK RATE VERSUS FRACTION LEAKING EQUATIONS

In chapter 5.0, tables 5-4 and 5-5 present equations that predict average leak rate based on the fraction leaking at SOCFI process units and refinery process units, respectively. Equations are presented for gas valves, light liquid valves, light liquid pumps, and connectors, and each of the equations are plotted in figures 5-1 through 5-8.

The equations are expressed in the following format:

$$\text{Average Leak Rate} = (\text{Slope} \times \text{Fraction Leaking}) + \text{Intercept}$$

The average leak rate has units of kilograms per hour per source. The fraction leaking is the fraction of sources that screen greater than or equal to the applicable leak definition. The leak definition is the screening value at which a leak is indicated. (For example an equipment leak regulation may have a leak definition of 10,000 ppmv.) Equations were developed for several possible leak definitions.

Using the applicable equation, if it is known what percentage of sources screen greater than or equal to the leak definition, then an overall average leak rate for all sources can be estimated. If the fraction leaking before and after an LDAR program is implemented are known, then the average leak rates before and after the program can be determined. These average leak rates before and after the program are used to calculate the control efficiency of the program.

The leak rate versus fraction leaking equations were developed using the following procedure:

- STEP 1: Determine average emission factors for (1) screening values greater than or equal to the applicable leak definition, and (2) screening values less than the applicable definition.
- STEP 2: The average emission factor for screening values less than the leak definition is the intercept in the equation.
- STEP 3: The average emission factor for screening values greater than or equal to the leak definition minus the average emission factor for screening values less than the leak definition is the slope in the equation.

An example of the above steps is presented for gas valves in a SOCFI process units for a leak definition of 10,000 ppmv. From table 2-4 the gas valve $\geq 10,000$ ppmv emission factor is 0.0782 kg/hr and the $< 10,000$ ppmv factor is 0.000131 kg/hr. Thus, the equation relating average leak rate to fraction leaking for SOCFI gas valves with a leak definition of 10,000 ppmv is as follows:

$$\begin{aligned} \text{Avg Leak Rate (kg/hr)} &= [(0.0782 - 0.000131) \times \text{FL}] + 0.000131 \\ &= (0.0781 \times \text{FL}) + 0.000131 \end{aligned}$$

where:

FL = Fraction leaking.

Notice that when applying the above equation if 100 percent of the gas valves screened less than 10,000 ppmv, the equation predicts an average leak rate equal to the $< 10,000$ ppmv factor. Similarly, if 100 percent of sources screened greater than or equal to 10,000 ppmv, the equation predicts an average leak rate equal to the $\geq 10,000$ ppmv factor.

For SOCFI process units, equations were developed for each of the equipment types for leak definitions of 500 ppmv, 1,000 ppmv, 2,000 ppmv, 5,000 ppmv, and 10,000 ppmv. For each of the leak definitions, the greater than or equal to factors and the less than factors were developed by entering the applicable

screening data from the combined screening data set into the applicable revised SOCFI correlation equation (see appendix B). For example, the <500 ppmv factor for connectors was estimated by entering all connector screening data with values less than 500 ppmv from the combined screening dataset into the revised SOCFI connector correlation equation. The sum of total emissions divided by the number of screening values gives the <500 ppmv connector average emission factor.

For refinery process units, equations were developed for each of the equipment types for leak definitions of 500 ppmv, 1,000 ppmv and 10,000 ppmv. The refinery $\geq 10,000$ ppmv and <10,000 ppmv emission factors had previously been developed and are presented in table 2-5. The same approach used to develop the $\geq 10,000$ / $<10,000$ ppmv refinery factors was used to develop the factors for leak definitions of 500 ppmv and 1,000 ppmv. This approach involves using information from the Refinery Assessment Study (EPA-600/2-80-075c) on the cumulative distribution of emissions and screening values.

G.2 CONTROL EFFECTIVENESS CALCULATIONS

In addition to the equations described in section G.1, chapter 5.0 presents estimated control effectiveness values at SOCFI and refinery process units for control equivalent to:

- (1) Monthly LDAR program with a leak definition of 10,000 ppmv;
- (2) Quarterly LDAR program with a leak definition of 10,000 ppmv; and
- (3) Control equivalent to the LDAR program required by the proposed hazardous organic NESHAP equipment leaks negotiated regulation.

Tables G-1 and G-2 summarize how the control effectiveness values of the above LDAR programs were determined for SOCFI and refinery process units, respectively.

The approach for calculating the control effectiveness of a LDAR program is discussed in detail in chapter 5.0. The approach involves determining the average leak rate before and after the LDAR program is implemented. The average leak rates before and

TABLE G-1. DETERMINATION OF LDAR CONTROL EFFECTIVENESS AT SOCMI PROCESS UNITS

Equipment type	Control program	Leak definition (ppmv)	Initial leak fraction (percent)	Initial leak rate (kg/hr)	Steady-state leak fraction after LDAR implemented (percent)			Final leak rate (kg/hr)	LDAR control effectiveness (percent)
					Immediately after LDAR monit.	Immediately prior to LDAR monit.	Cycle average		
LL Valves	Monthly	10000	4.3	0.0040	0.20	0.88	0.54	0.00064	84
	Quarterly	10000	4.3	0.0040	0.59	2.61	1.60	0.00159	61
	HON reg neg	500	8.5	0.0040	0.00	2.00	1.00	0.00050	88
Gas Valves	Monthly	10000	7.5	0.0060	0.29	1.29	0.79	0.00075	87
	Quarterly	10000	7.5	0.0060	0.86	3.80	2.33	0.00195	67
	HON reg neg	500	13.6	0.0060	0.00	2.00	1.00	0.00045	92
LL Pumps	Monthly	10000	7.5	0.0199	0.00	3.53	1.77	0.00613	69
	Quarterly	10000	7.5	0.0199	0.00	7.50	3.75	0.01092	45
	HON reg neg	1000	17.1	0.0199	0.00	8.04	4.02	0.00501	75
Connectors	HON reg neg	500	3.9	0.0018	0.00	0.50	0.25	0.00013	93

TABLE G-2. DETERMINATION OF LDAR CONTROL EFFECTIVENESS AT REFINERY PROCESS UNITS

Equipment type	Control program	Leak definition (ppmv)	Initial leak fraction (percent)	Initial leak rate (kg/hr)	Immediately after LDAR monit.	Immediately prior to LDAR monit.	Cycle average	Final leak rate (kg/hr)	LDAR control effectiveness (percent)
LL Valves	Monthly	10000	11.0	0.0109	0.39	1.72	1.06	0.00258	76
	Quarterly	10000	11.0	0.0109	1.15	5.07	3.11	0.00430	61
	HON reg neg	500	28.5	0.0109	0.00	2.00	1.00	0.00057	95
Gas Valves	Monthly	10000	10.0	0.0268	0.36	1.60	0.98	0.00317	88
	Quarterly	10000	10.0	0.0268	1.06	4.69	2.88	0.00813	70
	HON reg neg	500	24.0	0.0268	0.00	2.00	1.00	0.00120	96
LL Pumps	Monthly	10000	24.0	0.1140	0.00	11.28	5.64	0.03597	68
	Quarterly	10000	24.0	0.1140	0.00	24.00	12.00	0.06300	45
	HON reg neg	1000	48.0	0.1140	0.00	10.00	5.00	0.01365	88
Connectors	HON reg neg	500	1.7	0.00025	0.00	0.50	0.25	0.00005	81

after implementing the LDAR program are estimated by entering the fraction leaking before and after implementing the program into the equations described in section G.1.

For SOCFI process units, the fraction leaking before implementing the LDAR program was based on the percentage of equipment screening above the applicable leak definition in the combined SOCFI screening dataset. (See appendix B.) Similarly, the initial fraction leaking for refinery process units was based on data from the Refinery Assessment Study on the percentage of equipment screening above the applicable leak definition. Note that each of the initial leak fractions predict leak rates equal to the applicable SOCFI or refinery average emission factors (tables 2-1 and 2-2) when entered into the applicable equation described in section G.1. In other words, when estimating the control effectiveness for the SOCFI and refinery LDAR programs, it has been assumed that prior to implementing the program equipment leak emissions are equivalent to emissions that would be predicted by the average emission factors.

The fraction leaking after implementing the LDAR program is assumed to be the average of the "steady-state" fraction leaking immediately before and after a monitoring cycle (see discussion in chapter 5.0). The following parameters are used to estimate the steady-state leak fractions:

- recurrence rate,
- unsuccessful repair rate, and
- occurrence rate.

The values used for these parameters are summarized in table G-3 for both SOCFI and refinery process units.

The paragraphs below summarize the approach used to determine the above parameters. First, the approach used to determine the parameters in a program with a leak definition of 10,000 ppmv is described. Then, the approach used to determine the parameters in a program equivalent to the proposed hazardous organic NESHP equipment leaks negotiated regulation is described.

TABLE G-3. PARAMETERS USED TO CALCULATE STEADY-STATE LEAK FRACTION AFTER LDAR PROGRAM IS IMPLEMENTED

Equipment type	Control program	Leak definition (ppmv)	Recurrence rate ^a (percent)	Unsuccessful repair rate ^a (percent)	Initial leak fraction ^b (percent)	Occurrence rate ^c (percent)
<u>PARAMETER VALUES FOR SOCFI PROCESS UNITS</u>						
LL Valves	Monthly	10000	14	10	4.3	0.68
	Quarterly	10000	14	10	4.3	2.03
	HON reg neg	500	0	0	8.5	2.00
Gas Valves	Monthly	10000	14	10	7.5	1.00
	Quarterly	10000	14	10	7.5	2.97
	HON reg neg	500	0	0	13.6	2.00
LL Pumps	Monthly	10000	0	0	7.5	3.53
	Quarterly	10000	0	0	7.5	7.50
	HON reg neg	1000	0	0	17.1	8.04
Connectors	HON reg neg	500	0	0	3.9	0.50
<u>PARAMETER VALUES FOR REFINERY PROCESS UNITS</u>						
LL Valves	Monthly	10000	14	10	11.0	1.34
	Quarterly	10000	14	10	11.0	3.97
	HON reg neg	500	0	0	28.5	2.00
Gas Valves	Monthly	10000	14	10	10.0	1.24
	Quarterly	10000	14	10	10.0	3.67
	HON reg neg	500	0	0	24.0	2.00
LL Pumps	Monthly	10000	0	0	24.0	11.28
	Quarterly	10000	0	0	24.0	24.00
	HON reg neg	1000	0	0	48.0	10.00
Connectors	HON reg neg	500	0	0	1.7	0.50

^a The recurrence rate and unsuccessful repair rate for valves and pumps in LDAR programs with a leak definition of 10,000 ppmv was obtained from the SOCFI Fugitives AID (EPA-450/3-82-010). For the HON reg neg, a simplifying assumption was made that the recurrence rate and unsuccessful repair rate equal zero percent for all equipment types.

^b The initial leak fraction for SOCFI process units is based on the combined screening dataset. The initial leak fraction for refinery process units is based on data collected in the Refinery Assessment Study (EPA-600/2-8--075c).

^c The occurrence rate for LDAR programs with a leak definition of 10,000 ppmv is calculated as a function of the initial leak fraction. The relationship is based on data collected in the Six Unit Maintenance Study (EPA-600/S2-081-080). The equations for valves and pumps are as follows:
 Valve 30 Day Occurrence rate = 0.0976 * leak fraction + 0.264.
 Pump 30 Day Occurrence rate = 0.47 * leak fraction.
 The quarterly occurrence rate is approximately 3 times the 30-day occurrence rate. In cases where the quarterly occurrence rate exceeded the initial leak fraction, it was set equal to the initial leak fraction. The occurrence rate for the HON reg neg LDAR programs is set equal to the performance level, except for pumps in SOCFI process units. For pumps in SOCFI process units the occurrence rate is calculated using the equation above.

G.2.1 LDAR Program with Leak Definition of 10,000 ppmv.

Estimates for the recurrence rate and unsuccessful repair rate were obtained from the Fugitive Emissions Additional Information document (EPA-450/3-82-010). In this document, data collected for LDAR programs with a leak definition of 10,000 ppmv were summarized. It was concluded that the recurrence rate for valves was 14 percent and the unsuccessful repair rate for valves 10 percent. It was assumed that all pumps are replaced with a new seal and for that reason the recurrence rate and unsuccessful repair rate for pumps were both assumed equal to zero percent (i.e., all pumps are successfully repaired and leaks do not recur). Data were unavailable for connectors for an LDAR program with a leak definition of 10,000 ppmv, and, for this reason, control efficiency for connectors in an LDAR program with a leak definition of 10,000 ppmv have not been estimated.

Estimates for the occurrence rate were based on data collected in the Six Unit Maintenance Study (EPA-600/S2-081-080). Data from this study indicated that the occurrence rate is a function of the initial leak fraction. For valves this relationship was expressed by the following equation:

$$OCC_{\text{valve}} = 0.0976 (LF) + 0.264$$

where:

OCC_{valve} = Monthly occurrence rate for valves;
and

LF = Initial leak fraction.

For pumps, the relationship was as follows:

$$OCC_{\text{pump}} = 0.47 \times LF$$

where:

OCC_{pump} = Monthly occurrence rate for pumps; and

LF = Initial leak fraction.

For both pumps and valves, the monthly occurrence rate was used to estimate the quarterly occurrence rate using the following equation:

$$Q = M + M (1 - M) + M \{1 - [M + M (1 - M)]\}$$

where:

M = Monthly occurrence rate; and
Q = Quarterly occurrence rate.

Note that in cases where the estimated quarterly occurrence rate exceeded the initial leak fraction, it was set equal to the initial leak fraction.

G.2.2 Control Equivalent to the LDAR Program Required by the Proposed Hazardous Organic NESHAP Equipment Leaks Negotiated Regulation

For each of the equipment types, the proposed hazardous organic NESHAP LDAR program requirements include a performance level requirement. This performance level specifies the allowable leak fraction once the program is in place. For example, the performance level for valves is 2 percent. Because the proposed hazardous organic NESHAP rule contains the performance level requirement and because limited data are available on LDAR programs with the leak definitions of the proposed hazardous organic NESHAP rule, simplifying assumptions were made when estimating the recurrence rate, unsuccessful repair rate, and occurrence rate.

For each of the equipment types, it was assumed that the recurrence rate and unsuccessful repair rate were equal to zero percent. These two parameters have the least impact on the predicted control efficiency.

For valves and connectors, the proposed hazardous organic NESHAP rule allows for reduced monitoring frequency if the leak fraction remains below the performance level. For this reason, it was assumed that process units would monitor valves and connectors at whatever monitoring frequency (i.e., monthly, quarterly, annually, etc.) that allows them to meet the performance level. Thus, for valves and connectors the

occurrence rate was set equal to the performance level. Note that in cases where process units remain below the performance level this may overestimate the occurrence rate. However, this is offset by the assumption that the recurrence rate and unsuccessful repair rate are equal to zero percent.

For pumps the proposed hazardous organic NESHAP rule requires monthly monitoring. For this reason the occurrence rate was calculated using the same equation for pumps as presented in section G.2.1 for LDAR programs with a leak definition of 10,000 ppmv. Note, however, that the initial leak fraction used in the equation was the leak fraction associated with the leak definition of the proposed hazardous organic NESHAP rule (1,000 ppmv). For refineries, the predicted occurrence rate for pumps exceeded the performance level, and for this reason the occurrence rate was set equal to the performance level.

TECHNICAL REPORT DATA (Please read Instructions on the reverse before completing)		
1. Report No. EPA-453/R-95-017	2.	3. RECIPIENT'S ACCESSION NO.
4. TITLE AND SUBTITLE 1995 Protocol for Equipment Leak Emission Estimates	5. REPORT DATA November 1995	6. PERFORMING ORGANIZATION CODE
	7. AUTHOR(S) David L. Epperson	8. PERFORMING ORGANIZATION REPORT NO. DCN: 95-652-015-55-05
9. PERFORMING ORGANIZATION NAME AND ADDRESS Radian Corporation P.O. Box 13000 Research Triangle Park, NC 27709	10. PROGRAM ELEMENT NO.	11. CONTRACT/GRANT NO. 68-D1-0117, WA 155
	12. SPONSORING AGENCY NAME AND ADDRESS Director, Office of Air Quality Planning and Standards U.S. Environmental Protection Agency Research Triangle Park, N.C. 27711	13. TYPE OF REPORT AND PERIOD COVERED
15. SUPPLEMENTARY NOTES Project Officer is David W. Markwordt, Mail Drop 13 (919)-541-0837		
16. ABSTRACT The report presents standard protocols for estimating mass emissions from equipment leaks. Different approaches for estimating equipment leak emissions are described and several topics relevant to estimating equipment leak emissions (such as speciating emissions) are addressed. Information on how to perform a screening survey at a process unit is presented. Information on how a process unit can collect equipment leak rate data by enclosing individual equipment pieces and measuring mass emissions is provided. Also, information is provided that can be used to estimate the control efficiency of equipment leak control techniques. The document will help facilities generate accurate plant-specific equipment leak emission estimates.		
17. KEY WORDS AND DOCUMENT ANALYSIS		
a. DESCRIPTORS	b. IDENTIFIERS/OPEN ENDED TERMS	c. COSATI Field/Group
Synthetic Organic Chemical Manufacturing Petroleum Refining Organic Compounds	Fugitive Emissions Equipment Leaks Response Factors Screening Data Bagging Data Leak Detection and Repair	
18. DISTRIBUTION STATEMENT Release to Public	19. SECURITY CLASS (This Report) Unclassified	21. NO. OF PAGES 400
	20. SECURITY CLASS (This page) Unclassified	22. PRICE